



US Army Corps  
of Engineers®  
Portland District

B.A. KLATTE



# Rogue Basin Fisheries Evaluation

Effects of Lost Creek Dam on  
Spring Chinook Salmon in the Rogue River

Phase II Completion Report

Volume I

B.A. KLATTE

February 2000

EFFECTS OF LOST CREEK DAM ON SPRING CHINOOK SALMON IN  
THE ROGUE RIVER. PHASE II COMPLETION REPORT.

VOLUME I

Rogue Basin Fisheries Evaluation Project

Oregon Department of Fish and Wildlife

2501 SW First Avenue  
Portland, OR 97207

February 2000

The United States Army Corps of Engineers funded this project under contract  
DACW57-77-C-0033.

## CONTENTS

	<u>Page</u>
SUMMARY.....	1
Physical Factors.....	1
Juveniles.....	1
Adults.....	2
Freshwater Fisheries.....	4
Simulation Model.....	5
RECOMMENDATIONS.....	7
Reservoir Management and Operation of Lost Creek Dam.....	7
Management and Evaluation of Fishery Resources.....	9
INTRODUCTION.....	11
Approach.....	15
Study Area.....	18
METHODS.....	20
Physical Factors.....	20
Releases of Hatchery Fish.....	23
Juveniles.....	23
Laboratory Experiments.....	26
Emergence Timing.....	26
Abundance.....	27
Growth Rate.....	29
Age at Ocean Entry.....	30
Date of Ocean Entry.....	31
Length at Ocean Entry.....	33
Standardization of Scale Parameters.....	35
Adults.....	36
Life History.....	36
Abundance.....	39
Age at Maturity.....	42
Ocean Harvest.....	43
Ocean Harvest Rates.....	43
Migration Timing.....	44
Prespawning Mortality.....	45
Spawning Distribution and Timing.....	47
Freshwater Fisheries.....	48
Harvest Composition.....	51
Simulation Model.....	53
Analytical Procedures.....	54

## CONTENTS (continued)

	<u>Page</u>
RESULTS AND DISCUSSION.....	55
Physical Factors.....	55
Flow.....	56
Water Temperature.....	56
Turbidity.....	62
Gravel Size and Abundance.....	62
Juveniles.....	64
Emergence Timing.....	64
Abundance.....	67
Dewatering Mortality.....	75
Growth Rate.....	78
Age at Ocean Entry.....	86
Time of Migration.....	88
Size at Time of Migration.....	93
Adults.....	95
Abundance at Gold Ray Dam.....	95
Abundance at Cole M. Rivers Hatchery.....	99
Abundance at Spawning.....	100
Abundance at River Entry.....	101
Estimation of Ocean Harvest Rates.....	102
Abundance in the Ocean.....	106
Survival Rates between Age 1 and Age 2.....	130
Recruitment Rates.....	131
Ocean Harvest.....	131
Harvest Rate of Broods.....	132
Size at Maturity.....	133
Size in the Ocean.....	134
Maturity Rates.....	138
Age Composition.....	146
Run Composition.....	154
Migration Rate.....	156
Migration Timing.....	157
Prespawning Mortality.....	162
Spawning Distribution.....	169
Spawning Time.....	173
Freshwater Fisheries.....	181
Angler Effort.....	181
Catch Rate.....	185
Timing of Angler Catch.....	187
Catch Composition.....	190
Harvest.....	192
Harvest Rate.....	196
Fishery Selectivity.....	198

CONTENTS (continued)

	<u>Page</u>
Simulation Model.....	201
Model Structure.....	201
Model Evaluation.....	208
Sensitivity Analyses.....	209
Evaluation of Reservoir Release Strategies.....	211
Implications of Project Findings.....	212
ACKNOWLEDGEMENTS.....	218
REFERENCES.....	219

APPENDIX A. Relation Between Gregorian Day, Day-of-Year, and Week-of-Year.....	Volume II
APPENDIX B. Tables of Data and Analyses Related to the Development of Methods.....	Volume II
APPENDIX C. Tables of Data and Analyses Related to Studies of Physical Parameters of the Rogue River.....	Volume II
APPENDIX D. Tables of Data and Analyses Related to Studies of Juvenile Spring Chinook Salmon.....	Volume II
APPENDIX E. Tables of Data and Analyses Related to Studies of Adult Spring Chinook Salmon.....	Volume II
APPENDIX F. Tables of Data and Analyses Related to Studies of the Freshwater Fisheries for Spring Chinook Salmon.....	Volume II
APPENDIX G. Sensitivity Analyses from Model Simulations of Chinook Salmon Produced Upstream of Gold Ray Dam.....	Volume II

## SUMMARY

In this report, we evaluate the effects of Lost Creek Dam on spring chinook salmon *Oncorhynchus tshawytscha* produced in the Rogue River upstream of Gold Ray Dam. The project chronology presented at the end of this section, and the schematics presented in the Simulation Model section (see page 201), may help clarify findings listed in the summary. Summary items apply only to wild spring chinook salmon unless otherwise stated.

### Physical Factors

1. Reservoir operation increased flow in summer, decreased flow in winter and spring, and decreased the intensity of peak flows during winter in all downstream areas.
2. Reservoir operation decreased water temperature in summer and increased water temperature during autumn and winter in all downstream areas.
3. Water temperature three kilometers downstream of the dam decreased by an average of 2°C in early summer, and again in early summer, after a change in release strategies during the mid-1980s.
4. Simulation modeling is the best available method to estimate the effects of reservoir operation on water temperature.

### Juveniles

1. Simulation modeling of water temperature indicated that reservoir operation in 1978-86 caused fry to emerge early by 17-28 days.
2. Fry continued to emerge early after 1986 despite changes in release temperatures at Lost Creek Dam. Accelerated emergence timing was most evident for the progeny of females that spawned early.
3. Annual rates of juvenile production were primarily related to (1) intensity of peak flow during gravel incubation of eggs and alevins, (2) water temperature during gravel incubation of eggs and alevins, and (3) the number of spawned females.
4. Operation of Lost Creek Dam increased juvenile production by reduction of peak flows, but decreased juvenile production as a result of (1) blocked spawning habitat and (2) increased water temperature during the gravel incubation of eggs and alevins.
5. Spawning escapement limited juvenile production in most, and possibly all, years of the project.
6. Eggs and alevins that incubate in gravel redds can become dewatered during the period of reservoir filling when reservoir releases increase river flow while parents spawn.
7. Large changes in river flow caused fry to be dewatered and killed.

8. Juvenile growth rates increased during the initial years of reservoir operation (1978-85) and then decreased during the later years of reservoir operation (1986-90).
9. Annual growth rates were primarily related to the abundance of juvenile chinook salmon and water temperature.
10. Fish that matured at younger ages grew faster when juveniles in the Rogue River as compared to cohorts that matured at older ages.
11. Most juveniles entered the ocean in their first year of life and the relative abundance of older migrants decreased after reservoir operation.
12. Subyearling migrants entered the ocean earlier during the initial years of reservoir operation (1978-81) as compared to counterparts produced before reservoir operation. Data were insufficient to estimate the date of ocean entry for later years of reservoir operation.
13. Juveniles destined to mature at age 2 entered the ocean earlier as compared to cohorts that matured at older ages.
14. Date of ocean entry was primarily related to growth rate and water temperature. Broods that grew at faster rates entered the ocean earlier.
15. Juveniles were larger at ocean entry during the initial years of reservoir operation (1978-85) as compared to later years of reservoir operation (1986-90) and as compared to years before reservoir operation.

#### Adults

1. Passage estimates of wild and hatchery fish at Gold Ray Dam during 1942-94 averaged 31,000 spring chinook salmon and 3,300 fall chinook salmon. Annual estimates of spring chinook salmon varied between 6,000 and 90,000. Annual estimates of fall chinook salmon varied between 700 and 14,000.
2. Comparisons made with returns of wild spring chinook salmon to the North Umpqua River indicated that the operation of Lost Creek Dam was associated with (1) an increase in the production of wild fall chinook salmon, (2) a decrease in the production of wild spring chinook salmon, and (3) a decrease in production of all wild chinook salmon.
3. In terms of numbers of adult fish that passed Gold Ray Dam, returns of hatchery fish mitigated for spawning habitat blocked by Lost Creek Dam.
4. The percentage of hatchery fish among spring chinook salmon averaged 7% in the 1970's, 43% in the 1980's, and 70% in the early 1990's.
5. Fall chinook salmon accounted for 13% of the wild fish produced before reservoir operation and 24% of the wild fish produced after reservoir operation.
6. The El Niño event of 1982-83 increased rates of natural mortality among age 1-4 spring chinook salmon resident in the ocean during 1982-83.

7. Estimates of the number of wild spring chinook salmon alive in the ocean during spring of 1972-94 averaged about 137,000 age 2 fish, 61,000 age 3 fish, 27,000 age 4 fish, 4,000 age 5 fish, and less than 200 age 6 fish.
8. The number of wild age 2 spring chinook salmon resident in the ocean averaged about 240,000 fish for broods produced before reservoir operation and about 96,000 fish for broods produced after reservoir operation.
9. If the ages of adult fish are estimated, freshwater returns can usually be used to predict fish abundance in the ocean during the next spring.
10. The abundance of hatchery fish after the initial six months of ocean residence was primarily related to the number of smolts released, date of release, size at release, and various indexes of ocean productivity measured near the coast of southern Oregon. Factors related to the abundance of wild fish after the initial six months of ocean residence could not be quantitatively estimated.
11. Ocean fisheries annually harvested an average of 44,000 chinook salmon in 1974-93. Annual landings of spring chinook salmon averaged about 29,000 wild fish and about 14,000 hatchery fish. Annual landings of wild fall chinook salmon averaged about 1,600 fish.
12. Annual estimates of ocean harvest rates in 1977-93 ranged between 0.03 and 0.54 for age 3 fish and ranged between 0.04 and 0.80 for age 4 fish.
13. Production estimates averaged about 11 recruits per spawner and ranged between 1 and 37 recruits per spawner for wild spring chinook salmon from the 1974-89 brood years.
14. Adults matured at ages 2-6. Spring chinook salmon of hatchery origin, and wild fall chinook salmon, matured at younger ages as compared to wild spring chinook salmon.
15. Maturation rates of wild and hatchery fish affected contribution rates to recreational and commercial fisheries in the ocean. Older fish contributed to the ocean and freshwater fisheries at greater rates than younger fish.
16. Wild spring chinook salmon produced after reservoir operation matured at younger ages than counterparts produced before reservoir operation. Maturity rates of fish produced in the initial years of reservoir operation (1978-85) did not differ from those for fish produced in the later years of reservoir operation (1986-90)
17. Maturity rates of wild fish were primarily related to growth rates in the ocean and to growth rates of juveniles in freshwater.
18. Maturation rates of hatchery fish were primarily related to growth rates in the ocean, date of release from the hatchery, and to fish size when released from the hatchery.
19. Among fish of the same age, hatchery fish migrated upstream earlier than wild fish. Older fish migrated upstream earlier than younger fish among wild and hatchery fish.



20. Wild fish produced after reservoir operation migrated upstream later than wild fish produced before reservoir operation. Migration timing of wild fish was more highly related to water temperature when the fish were embryos than to water temperature or flow when the fish were adults.
21. Large numbers of adults died prior to spawning before and after operation of Lost Creek Dam. Annual mortality rates downstream of Gold Ray Dam ranged between 0% and 70%. Annual mortality rates upstream of Gold Ray Dam ranged between 1% and 63%.
22. Rates of prespawning mortality among wild and hatchery fish were primarily related to water temperature.
23. Fish that migrated earliest spawned farthest upstream and also spawned earliest.
24. Wild fish produced after reservoir operation spawned farther downstream and spawned later than counterparts produced before reservoir operation. In contrast, time of spawning did not change among hatchery fish.
25. A decrease in the relative abundance of early migrating adults was responsible for the downstream shift in the spawning distribution of spring chinook salmon.
26. The change to later spawning was most pronounced for early migrating spring chinook salmon. Late migrating adults were less affected.
27. Later spawning probably resulted from a decrease in the survival rate for progeny of early spawning adults.
28. Spawning time in the area just downstream of Lost Creek Dam was primarily related to (1) water temperature when eggs and alevins incubated in the gravel, (2) water temperature during spawning, and (3) the proportion of fall chinook salmon among the spawners.
29. Fall chinook salmon excavated few redds of spring chinook salmon, but probably interbred with the spring race. In the area where spawning of fall and spring races overlapped, spawning time differed little between races.
30. About 5% of the spring chinook salmon of hatchery origin spawned naturally rather than entering Cole M. Rivers Hatchery.

### Freshwater Fisheries

1. Estimates of freshwater harvest averaged 6,900 spring chinook salmon in 1956-94. These estimates only included those fish large enough to require entry on salmon-steelhead cards.
2. Annual harvest rates averaged 23% of spring chinook salmon that returned in 1961-94. Annual harvest rates averaged 13% in the lower river and 16% in the upper river (1971-94). These estimates only included those fish large enough to require entry on salmon-steelhead cards.

3. Fisheries for spring chinook salmon were age-selective. Older fish were harvested at greater rates than younger fish in the lower river and in the upper river.
4. Among fish of the same age, wild fish and hatchery fish were harvested at similar rates in the lower river fishery. In the upper river fishery, hatchery fish were harvested at only one-half of the rate for wild fish of the same age, probably because they entered Cole M. Rivers Hatchery while wild fish stayed in the river.
5. Harvest in the lower river fishery was primarily related to age at return, fish abundance, and flow during the fishery. Harvest in the upper river fishery was primarily related to age at return and the abundance of wild and hatchery fish.
6. Angler catch rates in the lower river and in the upper river were primarily related to fish abundance, flow, and water temperature.
7. Angler effort in the lower river was primarily related to fish abundance, flow, and water temperature. In contrast, angler effort in the upper river was primarily related to fish abundance.

#### Simulation Model

1. We developed a simulation model that reflected major life history events in fresh water and in the ocean. However, we were not able to simulate changes in rates of natural mortality in the ocean or the rate of natural mortality between the time of downstream migration and the initial six months of ocean residence.
2. Simulations indicated that the production, harvest, and mortality of wild chinook salmon was more greatly affected by changes in water temperature as compared to changes in river flow.
3. Simulations indicated that hatchery fish account for about 13% of the spring chinook salmon that spawn naturally when hatchery fish account for 75% of the run at Gold Ray Dam.

Chronology of key events related to work with wild spring chinook salmon conducted as part of the Lost Creek Dam Fisheries Evaluation Project.

---

- 1962: Reservoir construction is authorized by Congress.
- 1973: Dam construction begins. Proposal developed for fish research project (see Table 1, page 16, for initial goals and objectives). First mitigation releases from Cole M. Rivers Hatchery.
- 1974: Fish research project begins.
- 1976: Dam construction completed. Reservoir closes in autumn.
- 1977: Reservoir does not fill. Flow augmentation in summer is minimal.
- 1978: Reservoir fills and becomes fully operational. Sampling begins for juvenile fish produced during initial strategy of reservoir operation (see Table 1, page 16, for relevant changes in project goals and objectives).
- 1983: Sampling completed for fish produced before full reservoir operation.
- 1984: Outflow temperatures in late autumn and winter are decreased to evaluate effects on the fry production and time of gravel emergence.
- 1986: Sampling completed for anadromous salmonids other than spring chinook salmon. Fishery project goal and objectives are modified (see Table 1, page 16). Outflow temperatures in spring are decreased to evaluate effects on the production and life history of wild fish. Sampling begins for juvenile fish produced under changed strategies of water temperature releases.
- 1989: Sampling completed for fish produced during the initial strategy of reservoir operation.
- 1994: Sampling completed for fish produced during changed strategies of water temperature releases.
- 1996: Interpretations of scale collections completed.
-

## RECOMMENDATIONS

### Reservoir Management and Operation of Lost Creek Dam

The following recommendations are directed primarily to the United States Army Corps of Engineers (USACE), the agency responsible for managing the reservoir and releases from Lost Creek Dam. Cooperation of other state and federal agencies are needed to implement these recommendations.

1. Plans for reservoir releases should be developed seasonally and should incorporate estimates of the projected water yield from the Rogue River Basin and objectives identified by state and federal agencies responsible for management of fishery resources.
2. The simulation model described in this report can be used to help evaluate the responses of wild chinook salmon to alternative strategies of reservoir management (see Simulation Model, page 201).
3. The USACE should develop additional simulations for water temperature of the Rogue River under varied strategies of reservoir management. These simulations are needed to better allocate reservoir storage for the maintenance and possible enhancement of salmonids in areas downstream of Lost Creek Dam (see Evaluation of Reservoir Release Strategies, page 211). At a minimum, water temperature should be simulated for years of low, average, and high water yield; and should also be simulated under alternative management strategies of (1) use of hypolimnetic storage in summer, (2) use of hypolimnetic storage in autumn, and (3) equal use of hypolimnetic storage in summer and autumn.
4. The reservoir should be managed so that daily maximum water temperature does not exceed 18°C (65°F) at Agness in May-June. This recommendation is designed to minimize prespawning mortality among adult spring chinook salmon (see Prespawning Mortality, page 162).

Additional simulations of water temperature are needed to determine the flow that is required to attain the recommended water temperature. In the interim, the USACE should continue to coordinate annual efforts to identify the minimum flow at Agness needed to protect spring chinook salmon. Current information indicates that a flow of 4,000 cfs is sufficient. This interim target flow may change as more information becomes available.

5. The reservoir should be managed to minimize intensity of peak flows in downstream areas during November-March. This recommendation is designed to increase the survival rates of eggs and alevins that incubate in the gravel (see Abundance, page 67). Present strategies for reservoir operation decrease peak flows during operational seasons of flood control and conservation storage. We believe that the intensity of peak flows can be further decreased in years of high water yield.

Authorizing documents for the Rogue River Basin project designate flood control as the first priority for reservoir management. Storage in excess of the rule curve decreases reservoir capability for flood control. However, maintenance of the reservoir level below the rule curve can provide for additional reductions in peak flows.

The USACE should develop criteria for reservoir level in operational seasons for flood control and conservation storage. We believe reservoir level can be scaled to estimates of water yield in the area upstream of the reservoir. Reservoir level should be reduced when water content of the snowpack is great. Implementation of this recommendation would increase reservoir capacity for flood control and decrease intensity of peak flows in downstream areas.

6. Release of water stored in the reservoir during freshets should be managed so flow in downstream areas does not exceed the peak flow that previously occurred during the season. This recommendation is designed to increase survival rates of eggs and alevins that incubate in the gravel (see Abundance, page 67).

We recognize that this recommendation may conflict, at times, with flood control operations. For example, managers may seek to return the reservoir level to the authorized rule curve for short periods between large storms. However, when potential for further flooding is minimal, reservoir level should be returned to minimum pool for flood control (or lower) so as not to produce a new peak flow in downstream areas.

7. Release of water stored in the reservoir during flood control operations should be managed so that the rate of decrease in reservoir outflow does not exceed the rate of decrease in reservoir inflow following the freshet. This recommendation is designed to reduce the number of juvenile salmonids, including spring chinook salmon, that are stranded and killed as a result of flood control operations (see Dewatering Mortality, page 75).
8. Release of water stored in the reservoir during operations other than flood control should be managed so that the rate of decrease in reservoir outflow do not exceed maximum incremental rates of 150 cfs every three hours and 750 cfs daily. This recommendation is designed to reduce the stranding mortality of juvenile fish (see Dewatering Mortality, page 75). Transect surveys to determine the relationship between discharge and gravel coverage may produce more effective recommendations for the reduction of stranding mortality.
9. The reservoir should be managed so that there is minimal flow augmentation between 21 September and 15 November. This recommendation is designed to (1) minimize the probability that eggs and alevins of spring chinook salmon will be dewatered and killed during the subsequent filling of the reservoir (see Dewatering Mortality, page 75), (2) reduce the proportion of fall chinook salmon that migrate to spawning areas upstream of Gold Ray Dam (ODFW 1992), and (3) conserve cold hypolimnetic storage to reduce early emergence of spring chinook salmon fry (see Emergence Timing, page 64).
10. Reservoir storage that is not released to minimize prespawning mortality among fall chinook salmon (ODFW 1992) and spring chinook salmon should be released so as to decrease the water temperature to the greatest degree possible in the area downstream of Grants Pass during July-August. This recommendation is designed to provide more optimal water temperatures for juvenile salmonids resident in the area (ODFW 1992; ODFW 1994) and to decrease the number of juvenile salmonids, including spring chinook salmon, that are consumed by Umpqua squawfish (see Discussion:, page 129).

11. Recommendations for water temperatures to be released from Lost Creek Dam in March–October (see Evaluation of Reservoir Release Strategies, page 211) should be considered as interim recommendations that need to be evaluated upon the completion of additional simulations of water temperature by the USACE. These recommendations are designed to (1) minimize prespawning mortality among spring chinook salmon in the area upstream of Gold Ray Dam (see Prespawning Mortality, page 162), (2) minimize the risk of disease outbreaks among fish rearing at Cole M. Rivers Hatchery, and (3) conserve cold hypolimnetic storage for release in autumn, as described in the succeeding recommendation.
12. The temperature of water released from Lost Creek Dam should be as cold as possible during November–February. This recommendation is designed to minimize early emergence by fry of spring chinook salmon (see Emergence Timing, page 64) and should be evaluated upon the completion of additional simulations of water temperature by the USACE.
13. The USACE should monitor the quality and quantity of salmon and steelhead spawning habitat downstream of Lost Creek Dam. Reservoir construction terminated the recruitment of gravel from areas upstream of the dam and the recruitment of gravel, from an unknown distance downstream of the dam, may not be sufficient to prevent the additional loss of spawning habitat (see Gravel Size and Abundance, page 62).

*Lost Creek →*

#### Management and Evaluation of Fishery Resources

The following recommendations are directed primarily to the Oregon Department of Fish and Wildlife (ODFW), the lead agency for management of fishery resources in the Rogue River Basin. Cooperation of other state and federal agencies are needed to implement these recommendations.

1. Management objectives, in order of priority, should be developed annually by agencies responsible for the management of anadromous salmonids in the Rogue River Basin.
2. The simulation model described in this report can be used to help evaluate the responses of wild and hatchery chinook salmon to differing strategies of fisheries management (see Simulation Model, page 201).
3. Management plans and activities should recognize that wild and hatchery spring chinook salmon differ in life history and also differ in contribution rates to recreational and commercial fisheries.
4. Management plans and activities should recognize that modification of the current hatchery program to reflect life history parameters of the present population of wild spring chinook salmon will decrease the contribution rates of hatchery fish to recreational and commercial fisheries.
5. Management plans and activities should recognize that it is unlikely that the life history parameters of wild spring chinook salmon will be completely restored to preimpoundment conditions, unless Lost Creek Dam is removed.

6. Management plans and activities should recognize three populations of chinook salmon in the Rogue River upstream of Gold Ray Dam: (1) wild spring chinook salmon that pass Gold Ray Dam before 16 August, (2) early-run fall chinook salmon that pass Gold Ray Dam after 15 August, and (3) spring chinook salmon of hatchery origin.
7. All spring chinook salmon of hatchery origin should be marked with fin clips so that adult fish can be identified at Gold Ray Dam and so that known wild fish can be collected for hatchery broodstock.
8. Representative samples of each group exposed to differing hatchery practices should be marked with adipose fin clips and coded-wire tags in order to monitor and evaluate survival rates, maturation rates, and contribution rates to the ocean fisheries.
9. Maturation rates of the production group raised at Cole M. Rivers Hatchery should not exceed: 0.01 for age 2 fish, 0.10 for age 3 fish, 0.70 for age 4 fish, and 0.95 for age 5 fish in order to optimize contribution rates to the fisheries. Changes in broodstock selection practices may be needed to meet these targets.
10. Fall chinook salmon of hatchery origin should not be released in the area upstream of Gold Ray Dam.
11. Management of spring chinook salmon should be brought into compliance, or exempted from, the Wild Fish Management Policy that was adopted by the Oregon Fish and Wildlife Commission in 1992. Current management strategies are not in compliance with the policy because (1) hatchery fish now appear to compose more than 10% of the natural spawners, (2) wild fish compose less than 30% of the hatchery broodstock, and (3) wild-type phenotypes of the present population of wild fish are not maintained in hatchery fish.

Fishery managers have five options by which to bring management strategies for spring chinook salmon into compliance with the Wild Fish Policy: (1) release no hatchery fish, (2) limit the number of hatchery fish to less than 50% of the naturally spawning population and establish hatchery practices to include at least 30% wild fish in the broodstock and establish wild-type phenotypes among hatchery fish, (3) limit the number of hatchery fish to less than 10% of the naturally spawning population, (4) classify the production of hatchery fish as a special rehabilitation program, and (5) exemption from the policy. Implications associated with each of these options are discussed in the report (see Implications of Project Findings, page 212).

12. We recommend no adjustments to the management of the ocean fisheries for chinook salmon, except as outlined in the succeeding recommendation. Current programs designed to manage fall chinook salmon produced in the Klamath River Basin of northern California should provide sufficient protection to spring chinook salmon of Rogue River origin because both populations exhibit similar patterns of distribution in the ocean and contribute to the ocean fisheries at similar rates.

13. Management plans should identify a minimum spawning escapement for age 4-6 spring chinook salmon and should regulate harvest as needed to meet the goal. The management option selected under the Wild Fish Policy will probably affect any goal chosen for minimum spawning escapement. Our findings are insufficient for identification of specific spawning goals because we found a linear, rather than a curvilinear, relationship between spawning escapement and resultant juvenile production (see Abundance, page 67).
14. Habitat projects designed to maintain or increase the production of spring chinook salmon should be directed at gravel quality and quantity in the Rogue River and in Big Butte Creek (see Abundance, page 67).
15. Management plans for public and private lands in the Rogue River Basin should identify and minimize activities that may increase the intensity of peak flows in autumn-winter and may increase water temperature in summer (see Abundance, page 67).
16. Continual removal of Umpqua squawfish from the Rogue River should be supported to the greatest possible extent to reduce predation losses of juvenile chinook salmon (see Discussion:, page 129).
17. Information related to the impact of Umpqua squawfish on anadromous salmonids in the Rogue River should be publicized in order to decrease the chance that the species is unintentionally introduced into other coastal basins in southwest Oregon and northern California.

## INTRODUCTION

The Congress of the United States of America authorized construction of Lost Creek Dam (Figure 1) at river kilometer (RK) 254 to create a reservoir to be used for multiple purposes, including the enhancement of fishery resources in downstream areas (United States Congress 1962). An updated economic review in 1971 indicated planners projected fishery enhancement to be the third largest benefit accrued annually from the operation of the dam (USACE 1972). Spawning and rearing habitat for salmon and steelhead *Oncorhynchus mykiss* blocked or inundated by the dam was to be mitigated by releases of fish reared at Cole M. Rivers Hatchery. Benefits to anadromous salmonids in downstream areas were expected to accrue by operating the dam to (1) decrease peak flow in winter, (2) increase flow in summer, and (3) decrease water temperature in summer.

To regulate the outflow temperature from Lost Creek Dam, the USACE designed an intake structure capable of withdrawing water from five different levels of the reservoir (Figure 2). Selective opening of intake ports allows for mixing of water from various temperature strata in the reservoir. Choice of outflow temperature is greatest in early summer when the reservoir is full and thermally stratified. Control of release temperature diminishes in late summer as reservoir level decreases and the highest intake ports become dewatered. Control of release temperature becomes minimal in autumn after the reservoir destratifies (USACE 1983).



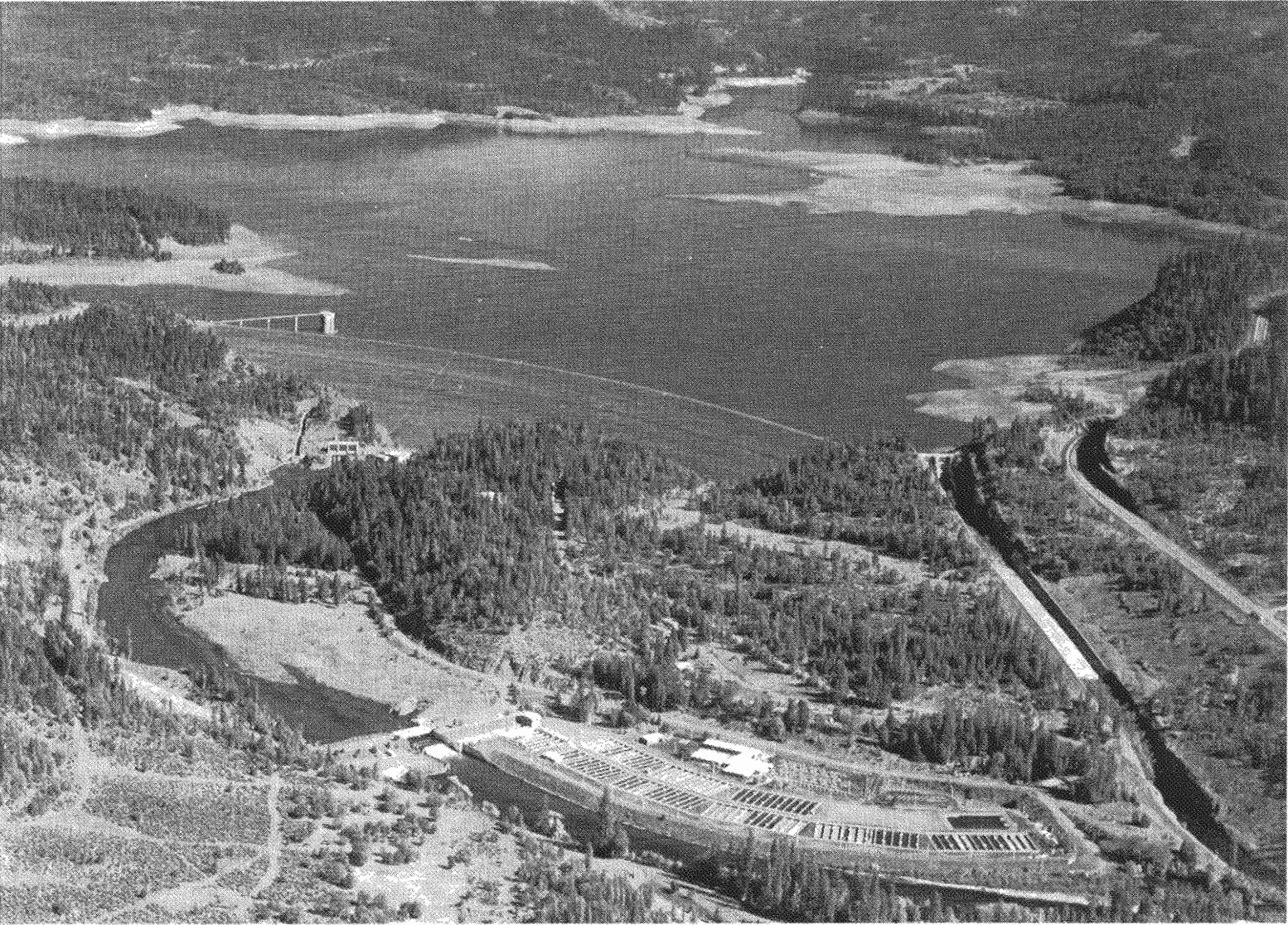

Figure 1. Lost Creek Dam and Cole M. Rivers Hatchery.

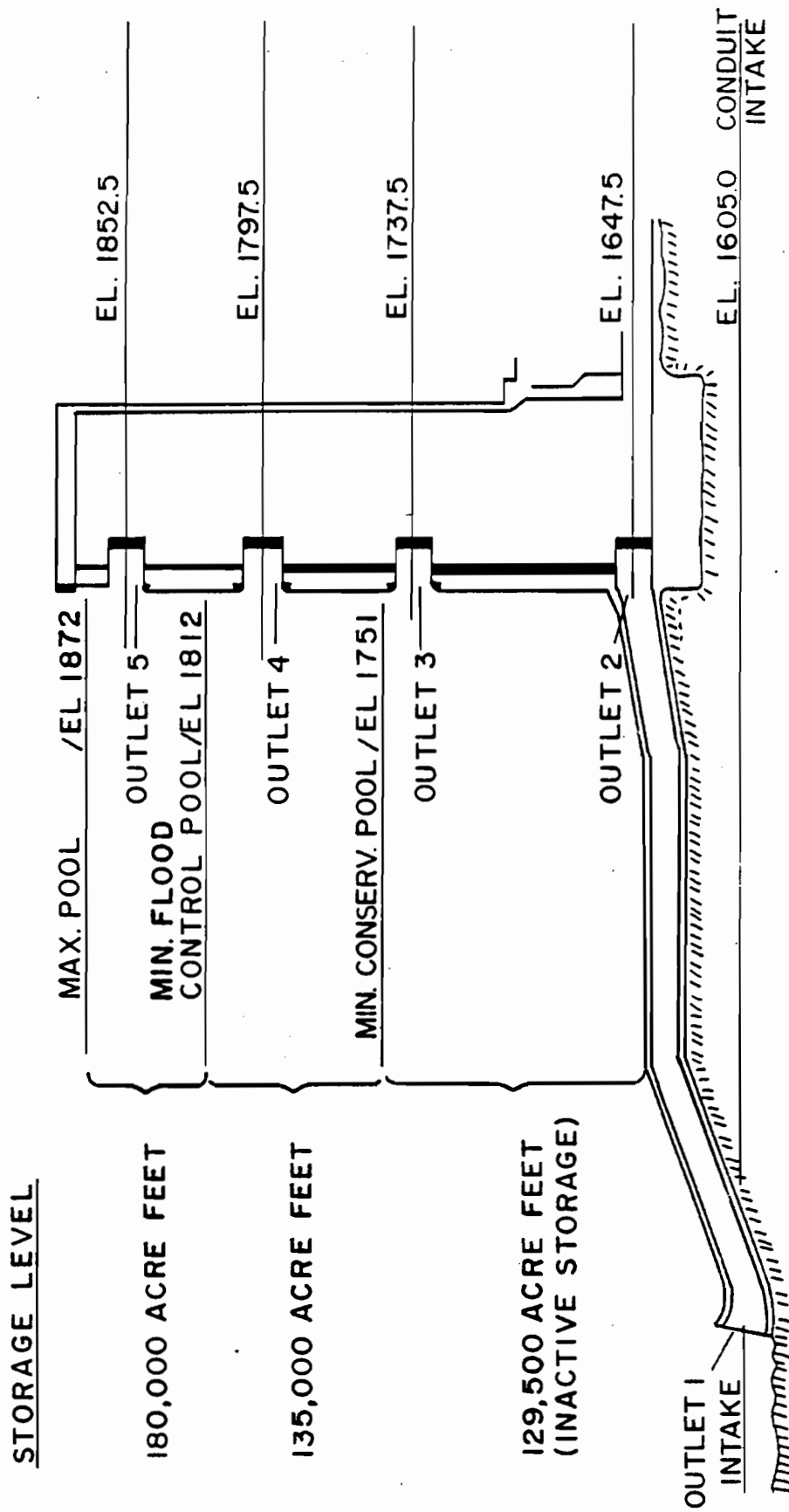

Figure 2. Schematic of the multiport intake structure for water withdrawal from five levels within Lost Creek Lake.

Guidelines for the release of stored water were intended to be flexible, reflecting annual variations in water yield and user demand. When the reservoir fills, 180,000 acre-feet of storage is available for flow augmentation (USACE 1972). Of this total, 125,000 acre-feet were authorized for fishery enhancement (United States Congress 1962). The remaining 55,000 acre-feet of storage was dedicated to other uses: irrigation supply, municipal and industrial supply, and environmental enhancement. Dedicated storage that is not purchased is also available for downstream enhancement of fishery resources (USACE 1972).

The authorizing document identified flood control as the primary benefit associated with the construction of Lost Creek Dam. Other benefits would accrue by allocating conservation storage to irrigation, future water supply, and fishery enhancement. There was to be "No storage specifically for wildlife enhancement, power generation, water quality control, or recreation" (United States Congress 1962).

The authorizing document also outlined minimum outflow and maximum water temperature to be released from Lost Creek Dam, but clearly stated these guidelines should be modified as additional information became available: "It should also be noted that project operation plans must be sufficiently flexible to permit desirable modifications in scheduled fishery releases, within the limits of storage provided therefore, if experience and further study indicates such action to be desirable for overall project benefits" (United States Congress 1962). Including provisions for modifications of release strategies for fisheries benefits was farsighted as predictions of postproject responses are rarely accurate because of the complexity of aquatic ecosystems (Rosenberg et al. 1986).

However, planners also noted negative impacts associated with the construction of Lost Creek Dam. The dam and associated facilities blocks approximately 33% of the spawning habitat of spring chinook salmon (USACE 1967). To mitigate for the loss of spawning habitat, the USACE built and funded the operation of Cole M. Rivers Fish Hatchery. Production goals for spring chinook salmon currently average about 1.6 million smolts annually.

Impacts were not limited to the blockage of spawning habitat. Our previous reports documented that the operation of Lost Creek Dam affected wild spring chinook salmon that inhabited the river downstream of the dam (Cramer et al. 1985; Satterthwaite 1987; ODFW 1991a). Some of the more important effects on wild fish were: (1) decreased production of fry and adult fish, (2) decreased recreational and commercial harvest, (3) a younger age at maturity, (4) later spawning and a shift in spawning distribution, and (5) increased returns of fall chinook salmon to spawning areas used historically by spring chinook salmon.

These findings concerned fishery managers because spring chinook salmon produced in the Rogue River Basin are an important fishery resource. Returns to the Rogue River constitute the largest run of spring chinook salmon on the Oregon coast (Nicholas and Hankin 1988). The run was at one time probably the most productive stock of spring chinook salmon south of the Columbia River and north of the Sacramento River. Spring chinook salmon that originate in the Rogue River Basin contribute to commercial and recreational fisheries in coastal waters of Oregon and northern California (Lewis 1997).

In 1985, ODFW proposed to evaluate two primary modifications to reservoir release strategies. These changes appeared to have the potential to minimize, or possibly negate, impacts on wild spring chinook salmon (Satterthwaite 1987). First, a decrease in outflow temperature during autumn was proposed as an experiment to increase the production of wild fish and to restore the historic times of spawning and migration. Second, a decrease in outflow temperature during spring and early summer was proposed as an experiment to restore the historic maturity rates of wild spring chinook salmon. Restoration of the maturity rates was identified as a project objective because recreational and commercial fisheries harvest chinook salmon in an age selective manner.

In this document, we report and compare key fishery parameters for spring chinook salmon produced during three periods of time: (1) before reservoir operation, (2) during initial reservoir operation, and (3) during modified reservoir operation. Project goals and objectives differed among these time periods (Table 1), particularly as the major impacts of reservoir construction and operation information became known.

In 1974-77, effort was primarily directed toward obtaining data that could be used to characterize river physical factors, fish abundance, fish life history, and harvest before operation of the reservoir. In 1978-85, effort continued to be directed toward obtaining similar types of data, but under the primary goal of developing of operational strategies for water released at Lost Creek Dam that would result in optimum production and harvest of anadromous salmonids in downstream areas. The primary purpose of work conducted in 1986-96 was to evaluate the modified strategy of water temperature releases implemented in 1986 (Table 1).

We also report relationships between physical factors of the Rogue River and key fishery parameters, and used many of those findings to develop recommendations designed to restore, as much as possible, the production and life history of wild spring chinook salmon. Many of the analyses also include fishery parameters for fall chinook salmon, but only for that portion of the run that colonized areas historically used by spring chinook salmon.

This document is the last report that evaluates downstream fishery resources in relation to the operation of Lost Creek Dam. Similar reports were completed for winter steelhead (ODFW 1990), coho salmon (ODFW 1991b), fall chinook salmon (ODFW 1992), and summer steelhead (ODFW 1994).

### Approach

We chose not to use the instream flow incremental methodology (Bovee 1982) for the development of flow recommendations. Although this approach has proved useful in some instances, the assumed direct relationship between weighted usable area and fish production is not always appropriate (Mathur et al. 1985; Moyle and Baltz 1985; Irvine et al. 1987). Our work centered primarily upon assessing the biological implications of modifications in flow, water temperature, and turbidity. During planning of the study, changes in these physical factors were expected to be most significant in the area of the river inhabited by spring chinook salmon.

Table 1. Goals and primary objectives of the Lost Creek Dam Fisheries Evaluation Project, 1974-96.

---

#### 1974-1977 Goals

1. Determine baseline conditions for major salmonid populations.
2. Develop data to assess impact of USACE dams on native salmonid populations.

#### 1974-77 Objectives

1. Determine the life history of juvenile chinook salmon; including growth, distribution, migration behavior, and time of ocean entry.
2. Determine the variation in juvenile life history and the relative contribution of each variant life history to the adult population.
3. Determine the spawning time and spawning distribution of adult chinook salmon.

#### 1978-1985 Goals

1. Determine the effects of Lost Creek Dam on anadromous salmonids.
2. Develop operating strategies that optimize the production and harvest of fishery resources in downstream areas.

#### 1978-85 Objectives

1. Determine changes in water temperature, flow, and turbidity which result from reservoir operation.
2. Determine the effects of Lost Creek Dam and develop criteria for its operation as related to the river sport fishery for adult salmonids.
3. Determine the effects of Lost Creek Dam and develop criteria for its operation as related to the abundance, migration, spawning, and size and age composition of adult salmonids.
4. Determine the effects of Lost Creek Dam and develop criteria for its operation as related to the rearing and migration of juvenile salmonids.

#### 1986-1996 Goal

Determine release strategies at Lost Creek that result in optimum production and harvest of wild spring chinook salmon.

#### 1986-96 Objectives

1. Determine the effect of the modified release strategy on water temperature.
  2. Determine the effect of water temperature on the production of wild juvenile spring chinook salmon.
  3. Determine the effect of water temperature on the maturity rate, race composition, and spawning time of adult chinook salmon.
  4. Develop recommendations for reservoir release strategies during years of varied water yield in the Rogue River Basin.
-

We devised two types of comparisons to meet project goals and objectives. First, we compared biological parameters of spring chinook salmon that inhabited the Rogue River before and after (under two release strategies) the operation of Lost Creek Dam. Second, we estimated the relationships between biological and physical factors to simulate biological responses to changes in physical factors influenced by the operation of Lost Creek Dam. Each method had associated strengths and weaknesses.

Temporal comparisons proved valuable. Sampling conducted prior to the operation of Lost Creek Dam provided information on the interannual variability of life history parameters. Sensitivity analyses after the initial years of the study led us to terminate work with algal and invertebrate communities. High variability among the data meant there was a low probability of associating any changes in production or community structure with the operation of the dam. Life history parameters of chinook salmon exhibited less variability.

However, temporal comparisons had some limitations. Given the expected variability, many years of data are required to make effective comparisons. We had only five years of returns for adults that reared as juveniles in freshwater before reservoir operation. Although the dam was operational in 1977, low water yield produced negligible storage for flow augmentation. Consequently, we treated data from 1978 as the first postimpoundment year.

Comparisons of conditions in preimpoundment and postimpoundment years were confounded by changes in factors other than the treatment. For example, water yield from the basin differed significantly before and after operation of Lost Creek Dam. Consequently, we attempted to identify the factor(s) responsible for concomitant changes in parameters.

Identification of factors associated with changes in biological parameters was approached by correlation and regression analyses. We reviewed the literature for background information on causative relationships among biological and physical factors. Factors that appeared to be most important were included as independent variables in regression analyses. We used regression analysis to estimate relationships between biological and physical factors. Limitations and potential problems with this approach are discussed in detail (see Analytical Procedures, page 54).

Quantitative estimates are particularly useful if reliable predictions of impacts can be generated (Rosenberg et al. 1986). We developed a simulation model from some of the important findings. We believe that the model can be used to evaluate the effects of varied strategies of reservoir management on the production and harvest of spring chinook salmon. We also believe that simulations can be useful in identifying optimal strategies for reservoir management and operation of Lost Creek Dam.

However, there are problems associated with this method. In particular, small sample sizes, irrelevant independent variables, estimation beyond the range of observed data, measurement errors, and intercorrelation among the stages of the simulation model may lead to erroneous conclusions from simulations. Potential biases, and the means we adopted to minimize biases, are discussed in greater detail (see Analytical Procedures, page 54).

Despite problems related to simulation analysis, we believe it is a practical tool for judging effects of varied strategies for reservoir management. Also, our simulation model should provide resource managers with a useful description of the life history of spring chinook salmon in the Rogue River Basin. Finally, predictions can be used to develop additional experiments within the context of active adaptive management (Walters 1986). To improve reliability of predictions, the model should be updated as new information becomes available.

### Study Area

The Rogue River Basin encompasses 13,150 square kilometers of southwestern Oregon and a small portion of northwestern California (Figure 3). Approximately 13% of the basin is upstream of Lost Creek Dam. The Rogue River originates in the Cascade Mountains and flows west, breaching the Klamath Mountains prior to reaching the Pacific Ocean. Two major tributaries, the Illinois and Applegate rivers, originate in the Siskiyou Mountains and flow north where they enter the Rogue River at RK 44 and 154, respectively.

The Rogue River estuary is relatively small, covering an area of about 630 acres at mean high tide. Ratti (1979) reported about 80% of the estuary could be classified as a riverine subsystem and 20% could be classified as a marine subsystem. Tidelands, marshes, and eelgrass beds are noticeably absent in the estuary.

Two USACE dams affect the timing of water yield in the Rogue River Basin. Lost Creek Dam at RK 254 on the Rogue River began operating in February 1977. Applegate Dam, at RK 75 on the Applegate River, began operating in November 1980 and affects flow in the Rogue River downstream of Grants Pass. Operation of Applegate Dam has a lesser effect on flow of the Rogue River because the storage capacity of Applegate Lake is one-third that of Lost Creek Lake.

The Rogue River Basin yields an average of 7.4 million acre-feet of water annually (Friday and Miller 1984). The Illinois and Applegate rivers average approximately 40% and 7% of the water yielded annually in the basin, respectively. The Rogue River upstream of Lost Creek Dam accounted for an average of 18% of the water yielded annually in the basin.

In the lower portion of the basin, river flow varies markedly among seasons. Discharge upstream of the mouth of the Illinois River averages 1,400 cfs in September and 16,200 cfs in January. The variation in flow is less pronounced in the upper portion of the basin. Flow into Lost Creek Lake averages 1,000 cfs in September and 2,000 cfs in January (Moffatt et al. 1990). Reservoir inflow usually peaks when the snowpack in the Cascade Mountains melts at a rapid rate between April and June.

Weather patterns in the northeast Pacific greatly affect climate within the Rogue River Basin. Wet, mild winters and dry, warm summers characterize the climate. Air temperature near Medford usually peaks between 32°C and 35°C in July and August. In December and January, air temperature usually peaks between 8°C and 10°C. Snow accumulates at the higher elevations in winter and is the principal source of water yield in spring and early summer. Annual precipitation averages about 50 cm in the inland valley surrounding Medford.

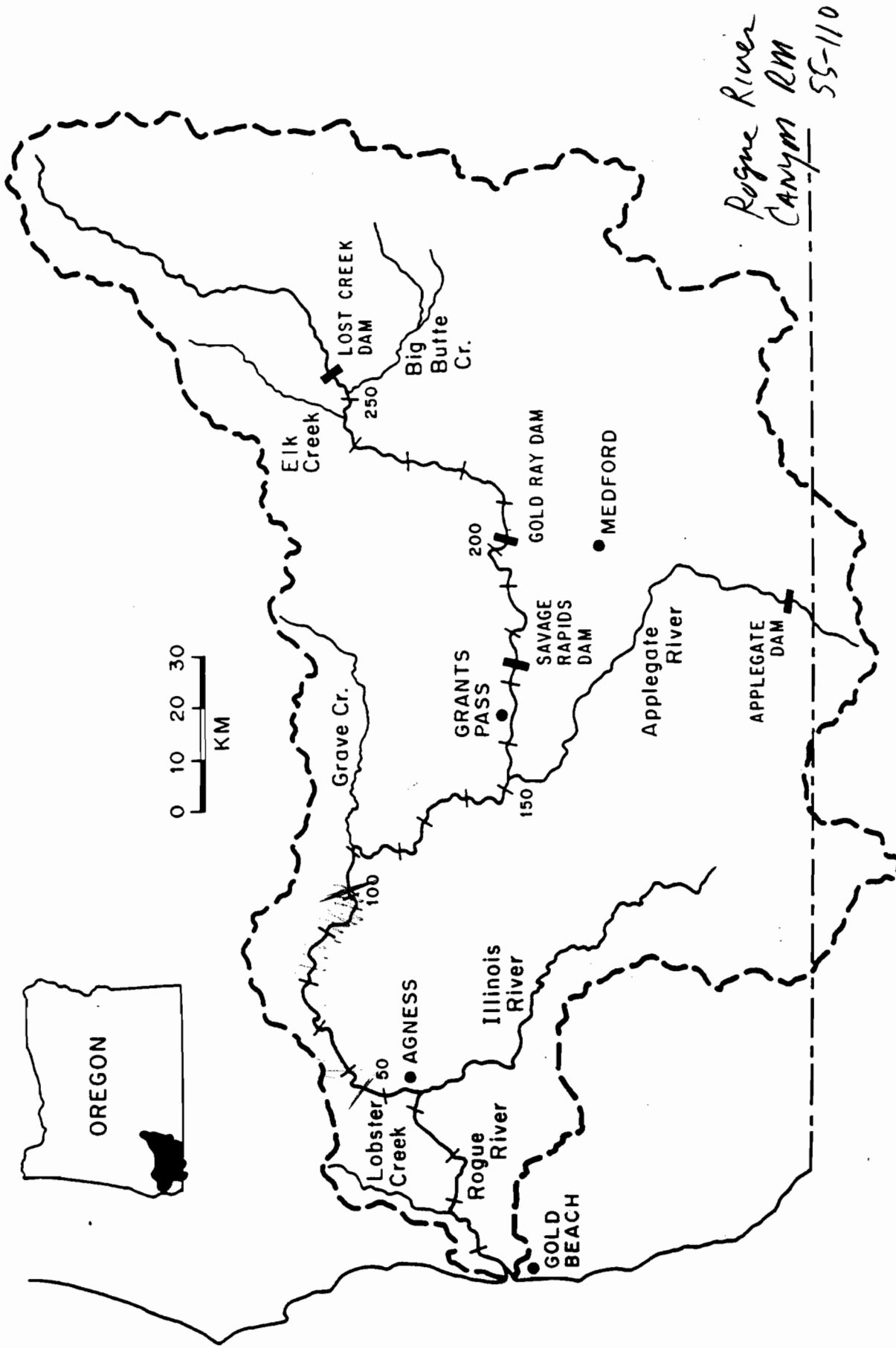

Figure 3. Map of the Rogue River basin. Numbers indicate kilometers from the river mouth.



Coastal and headwater regions receive an average annual precipitation of about 200 cm and 300 cm, respectively (ODWR 1985). About 50% falls from November through January. Less than 2% falls in July and August.

A large number of anadromous fish inhabit the Rogue River Basin. Chinook salmon and steelhead are the most abundant salmonids. Coho salmon *O. kisutch* are present in tributary streams. Chum salmon *O. keta* and pink salmon *O. gorbuscha* are occasionally found in tributaries of the lower river. Resident salmonids include rainbow trout *O. mykiss*, cutthroat trout *O. clarki*, brown trout *Salmo trutta*, and brook trout *Salvelinus fontinalis*. Few resident salmonids inhabit areas accessible to anadromous salmonids. Other commonly seen game fishes include largemouth bass *Micropterus salmoides*, bluegill *Lepomis macrochirus*, green sturgeon *Acipenser medirostris*, white sturgeon *A. transmontanus*, American shad *Alosa sapidissima*, and brown bullhead *Ictalurus nebulosus*. Nongame fishes abundant in the basin include reddsider shiner *Richardsonius balteatus*, Klamath smallscale sucker *Catostomus rimiculus*, common carp *Cyprinus carpio*, prickly sculpin *Cottus asper*, riffle sculpin *C. gulosus*, and Pacific lamprey *Lampetra tridentata*. The distribution of northern squawfish *Ptychocheilus oregonensis* is rapidly expanding after an illegal introduction in 1979.

For discussion purposes, we divided the Rogue River into four general areas. The upper river refers to the area between Lost Creek Dam and Gold Ray Dam (RK 202). The middle river refers to the area between Gold Ray Dam and Grave Creek (RK 110). The canyon refers to the area between Grave Creek and Agness (RK 44). The lower river refers to the area between Agness and the estuary (RK 6). Stream gradient averages 2.3 m/km in the upper river, 1.6 m/km in the middle river, 2.4 m/km in the canyon, and 0.7 m/km in the lower river.

## METHODS

We converted Gregorian calendar dates to day-of-year and week-of-year (APPENDIX A) for data analyses. We present some findings as calendar dates to clarify results.

### Physical Factors

The United States Geological Survey (USGS) operated automated gages at numerous sites in the Rogue River Basin during the project. USACE personnel used data from USGS gages in the Rogue River Basin to estimate effects of operation of Lost Creek and Applegate dams on water quality parameters in downstream areas in 1978-86. Hamlin and Nestler (1987) described the development of a QUAL II model specific to the Rogue River Basin.

The QUAL II model was used to simulate flow, water temperature, and turbidity for regulated and unregulated conditions. Regulated conditions simulated the Rogue River with Lost Creek and Applegate dams operating. Unregulated conditions simulated the Rogue River as though the dams had not been built. Simulations encompassed the time periods of January 1978 through September 1986 for flow and January 1978 through December 1986 for water temperature and turbidity. Model simulations produced estimates of daily means for physical factors at six gages operated by the USGS (Table 2).

Table 2. Descriptions of USGS stations operated in the Rogue River Basin that produced data used in this report.

Station	RK	Years of gage operation		USACE simulations <sup>a</sup> for 1978-86
		Flow	Water temperature	
<b>ROGUE RIVER</b>				
At McLeod	251	--	1973-95	--
Near McLeod	249	1965-95	1970-95	F,WT,T
Dodge Bridge	224	1938-95	1973-95	F,WT,T
Raygold	203	1905-95	1973-95	F,WT,T
Grants Pass	165	1938-95	1973-87	F,WT,T
Merlin	140	--	1974-87	--
Marial	78	--	1974-87	WT,T
Agness	48	1960-95	1960-87	F
<b>TRIBUTARIES OF THE ROGUE RIVER</b>				
Big Butte Creek	1	1967-95	1970-95	--
Applegate River	12	1978-95	1978-95	--

<sup>a</sup> *F = flow, WT = water temperature, and T = turbidity.*

Operation of Lost Creek Dam affected water quality and quantity at all USGS gages in downstream areas. After November 1980, operation of Applegate Dam affected physical parameters of the Rogue River at gages downstream of the Applegate River.

We used results from USACE modeling to estimate the effect of dam operations on water quality and quantity in downstream areas used by anadromous salmonids. We received data for flow simulations from Rock Peters, USACE, Portland District, on 24 April 1989. We received data for water temperature and turbidity simulations from Carla Haake, USACE, Portland District, on 25 May 1989.

We summarized flow and water temperature data from USGS stations on the Rogue River by month and by week-of-year (APPENDIX A). We used daily maximum water temperature because data for mean water temperature was not available prior to the summer of 1978.

Missing flow data were estimated by the USGS. We used regression analysis to estimate missing water temperature data. Data from the closest upstream and downstream gages were used as independent variables to predict water temperature missing for gages upstream of Merlin. Separate regressions were developed for the years before and after the operation of Lost Creek Dam. Missing water temperature from gages farther downstream were estimated by using data from the closest gage.

Predictive regressions were built specific to the time periods of missing data and included a maximum of 8 weeks of data to minimize the potential for

serial correlations. Day-of-year or week-of-year were also included as independent variables. Only significantly ( $P \leq 0.05$ ) related variables were used to predict missing temperature data.

We developed 29 regressions to predict missing water temperature data. Standard errors of the estimates of water temperature ranged between 0.19 and 0.67. Dividing the standard errors of the estimates by mean water temperatures in the data produced relative values that ranged from 2% to 9%. These results indicate that regressions were effective in prediction of missing water temperature data.

We predicted water temperature at the Marial gage in May and June of 1988-94. Predicted data were needed to determine the relationship between water temperature and the rate of prespawning mortality among adult spring chinook salmon. Because the Agness gage discontinued operation in 1987, we included flow at Grants Pass and flow and water temperature at the RK 12 gage on the Applegate River as independent variables. The independent variables were significant (all  $P < 0.001$ ) in the regression and accounted for 94% of the variation in mean weekly water temperature at the Marial gage in 1979-87. We found that 79% (48/61) of the predicted values were within  $1^{\circ}\text{C}$  of the values observed in 1974-87 (Figure 4). Based on these results, we used data from the independent variables to predict water temperature at the Marial gage in 1988-94.

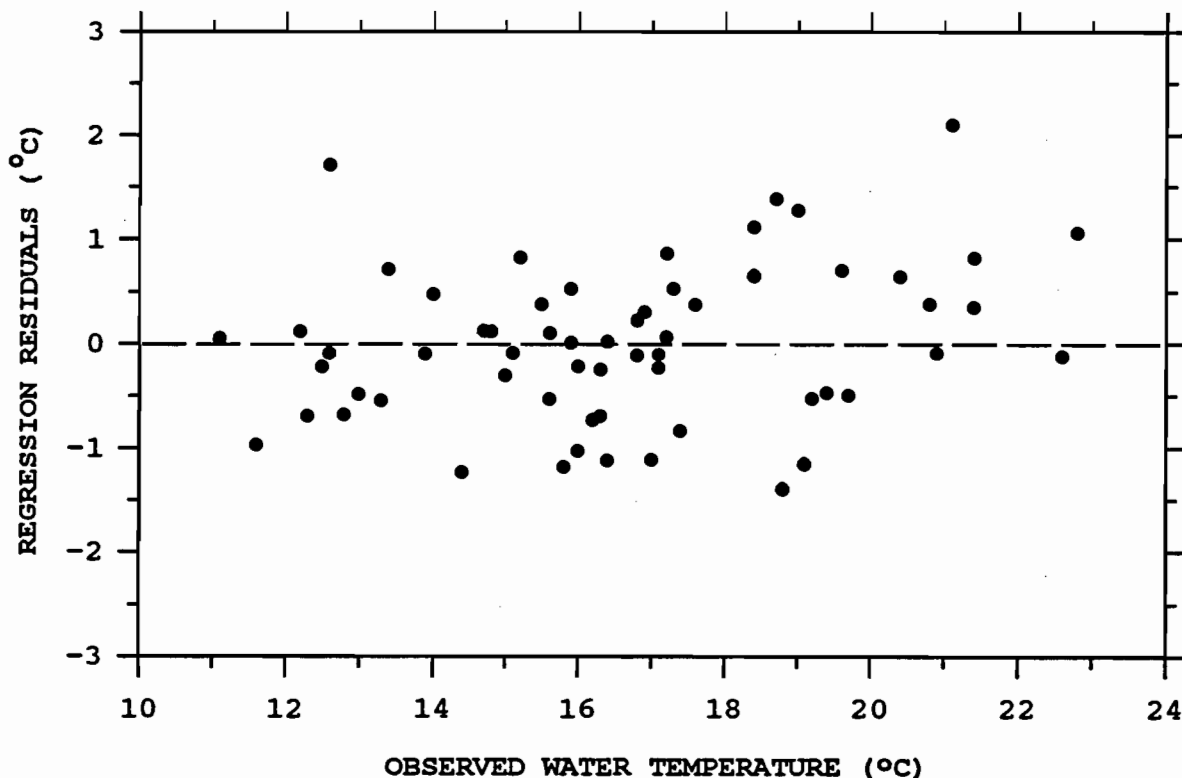

Figure 4. Residuals from the regression of maximum daily water temperature at Marial in May-June, averaged by week, plotted on observed values.

We also developed a predictive model of water temperature at the Marial gage that was designed to be used by reservoir managers on a daily basis in late spring of 1994. Daily maximum water temperature was the independent variable. Dependent variables in the regression included maximum air temperature at the Medford airport, flow at Agness, and day-of-year. Data covered the period of May-June in 1977-87.

We sampled three sites in the channel of the Rogue River and one site in Big Butte Creek at RK 0.2 to estimate gravel size and composition in 1978 and 1981. Methods for the estimation of gravel size generally followed those of Shirazi and Siem (1979), except that we used a 30 diameter cylinder to collect samples to a depth of 30 cm in 1981. Material collected in the cylinder was washed through a 63 micron sieve.

In 1981, we also sampled the armor (surface) layer by collecting 50 pieces of gravel at one foot intervals along a measuring tape. The pieces were sorted in sieves with 0.063-63.0 mm mesh screens. Rocks wider than 63 mm in diameter were grouped into diameter intervals that increased by 2.5 cm over the range of 10-20 cm.

### Releases of Hatchery Fish

Spring chinook salmon of hatchery origin have been released in the Rogue River Basin since 1877 (Rivers 1964). The 1943-71 brood years were raised at Butte Falls Hatchery and the releases are listed in Appendix Table B-1. The 1972-92 brood years were raised at Cole M. Rivers Hatchery and the releases are listed in Appendix Table B-2.

Fall chinook salmon of hatchery origin have also been released in the Rogue River Basin. Groups released in the Rogue River Basin upstream of Grants Pass are listed in Appendix Table B-3.

### Juveniles

We seined juvenile chinook salmon at 11 sites in the Rogue River, two sites in the estuary, and in one tributary stream during 1974-94 (Table 3). We used a 50-foot by 8-foot floating seine with 1/4-inch square mesh, double leaded, attached to a "many ends" bottom line except in the lower river, where we used a 100-foot by 8-foot floating seine with 1/4-inch or 3/8-inch square mesh. We used the net with smaller mesh when juveniles were smaller than 5 cm. When juveniles exceeded 5 cm, we used the net with larger mesh. In the estuary, we seined the Coast Guard site with a 350-foot by 17-foot floating seine that varied from 3/8-inch mesh in the bag to 1-inch mesh in the wings.

We seined each site weekly, except we seined sites in the canyon on alternate weeks. We made two sets at sites, except we made one set at sites in the lower river. Catch rates of juveniles were calculated from standard sampling effort. We sometimes made additional sets to meet sampling goals for lengths, weights, and scales.

We operated bypass traps on irrigation diversions at Table Rock (RK 209) and at Savage Rapids Dam (RK 173). In 1976-81 and in 1983, the trap at Table

Table 3. Sites seined for juvenile spring chinook salmon in the Rogue River basin, 1975-95. At sites downstream of High Banks, juvenile spring chinook salmon could not be distinguished from juvenile fall chinook salmon unless marked with fin clips (hatchery fish only) or cold brands.

Sampling site	RK	Time period	Frequency	Years
<b>ROGUE RIVER</b>				
Sand Hole	251	Jan-Oct	weekly <sup>a</sup>	1975-94
High Banks	209	Jan-Oct	weekly <sup>a</sup>	1975-94
Valley of the Rogue	183	Jan-Oct	weekly	1976-81
Matson Park	148	Jan-Oct	weekly	1975-86 <sup>b</sup>
Almeda Park	116	Jan-Oct	weekly	1975-86 <sup>b</sup>
Whiskey Bar	105	Apr-Sep	biweekly	1975-86 <sup>c</sup>
Winkle Bar	85	Apr-Sep	biweekly	1975-81 <sup>c</sup>
Illahe	56	Apr-Sep	biweekly	1975-81
Agness	44	Mar-Oct	weekly	1974-81
Hideaway	24	Mar-Oct	weekly	1974-81
Canfield	8	Mar-Oct	weekly	1974-82
<b>ESTUARY</b>				
Mail Boat Point	3	Apr-Oct	weekly	1974-81
Coast Guard	1	Apr-Oct	weekly	1974-82
<b>TRIBUTARIES OF THE ROGUE RIVER</b>				
Big Butte Creek	1	Jan-Oct	weekly	1976-81

<sup>a</sup> Sampled in April-May, 1982-95.

<sup>b</sup> Not sampled in 1982. Sampled during May-August, 1983-86.

<sup>c</sup> Not sampled in 1982-83. Sampled in May-October, 1984-86.

Rock fished continuously from March through August. The trap at Savage Rapids Dam fished 4-5 nights weekly from early May through September in 1974-90. Juvenile fish diverted from an 800 cfs withdrawal were captured in a bypass trap screened with 1/4-inch square mesh.

We segregated fish by species and age class. We differentiated wild fish and unmarked hatchery fish by comparing the length frequency distribution of marked hatchery fish with the length frequency distribution of wild fish caught during the previous week. We judged this method to be very effective in differentiating wild fish from hatchery fish that were released in August through March. The smallest group of hatchery fish among the August-March releases averaged 14.2 cm in length (Evenson and Ewing 1988), while few wild fish exceeded 13.0 cm when trapped at Savage Rapids Dam. In addition, trap catches of marked fish suggested that hatchery fish released in August-September migrated quickly downstream as almost all passed the trap at Savage Rapids Dam within two weeks.

Separation of wild fish from unmarked hatchery fish released in June was more difficult. Unmarked hatchery fish were released in June during 1984, 1986, and 1987 (Appendix Table B-2). Mean lengths of these fish at time of release averaged 9.8 cm in 1984, 9.3 cm in 1986, and 10.2 cm in 1987.

We anesthetized juveniles with benzocaine or a mixture of tricaine methanesulfonate (MS-222) and quinaldine (Schoettger and Steucke 1970). We measured fork lengths, to the nearest 1 mm, of 30 juveniles from each age class captured weekly at each site. We weighed, to the nearest 0.1 g, 25 subyearlings monthly at each site. We sampled scales from 20 subyearlings weekly at Table Rock and Canfield in 1974-81, and at Savage Rapids Dam in 1982-85. We removed approximately 10 scales from an area 4 rows above the lateral line, immediately posterior to the dorsal fin.

We mounted scale samples on glass slides with a solution of 5% glycerin and 95% sodium silicate. We mounted 10 scales per juvenile and interpreted 2 of the larger, non-regenerated scales of regular shape. Scales were measured at a magnification factor of 88. We measured and counted circuli in the anterior region of the scale along the longer of two lines at 20° angles from the longitudinal midline of the scale.

We estimated parameters of juvenile life history from the freshwater component of scales taken from adult spring chinook salmon trapped at Gold Ray Dam in 1974-94, except that we supplemented the 1992 samples with scales collected from spawned carcasses of fish classified as wild by the scale analyst. Parameters associated with juvenile life history did not differ significantly between the two sets of scales collected in 1992 even though sensitivity analyses indicated there were good chances of detecting differences (Satterthwaite and Apke 1993).

We recognize that parameters estimated from adult scales may not be unbiased samples of juvenile life history. For example, juvenile salmonids that grow at slower rates are susceptible to increased rates of predation (Parker 1971). Ward et al. (1989) found that juvenile steelhead migrated from the Keogh River, British Columbia, at a mean length of 17.6 cm while scales from adult cohorts indicated that migrants averaged 19.3 cm in length.

We estimated selected parameters of juvenile life history for individual age classes of adults and for completed brood years. We previously reported values for brood years that were weighted by the abundance of each age class at Gold Ray Dam (Cramer et al. 1985). However, because rates of natural and fishing mortality varied between years, scale parameters weighted for solely by freshwater returns can bias estimates of life history composition. For example, age 5 spring chinook salmon would compose greater proportions of freshwater returns if not harvested at age 3 and age 4 in ocean fisheries (Ricker 1980; Hankin and Healey 1986).

To circumvent the bias associated with age selective mortality, we estimated the age composition of each brood year as if there had been no ocean harvest and as if the El Niño event of 1982-83 had not occurred. Sequentially, the steps were:

1. Estimate the number of age 2 fish resident in the ocean during spring (see *Abundance in the Ocean*: , page 106).

2. Set rates of fishing related mortality in the ocean to zero.
3. Assume a natural mortality rate of 0.2 during winter, except assume a mortality rate of 0.5 between ages 2 and 3.
4. Use observed estimates of maturity rates to predict freshwater returns.
5. Estimate the age composition of completed broods from predictions of freshwater returns.

### Laboratory Experiments

Eggs and alevins produced by wild spring chinook salmon spawned at Cole M. Rivers Hatchery in 1975 were incubated at a constant temperature of 10°C at the ODFW research laboratory in Corvallis. Fry that averaged 4.4 cm in length were transferred to six 1,200 liter circular tanks on 27 February, 1976 and were reared at a constant temperature of 8°C through December. Fish in each tank were fed daily rations at different rates that ranged between 0.75% and 2.20% of the their body weight.

We obtained scale samples monthly between May and November, except no scales were taken in September. We randomly sampled 15 fry from each tank monthly, except we sampled 30 fry from each tank in November. Scale mounting and measurement procedures were the same as described earlier for the sampling of wild fish. We estimated average daily growth rates as the change in mean lengths during the 250 days between when fry were transferred to rearing tanks and when the last scale samples were taken in November.

### Emergence Timing

We designated the date of first capture of chinook salmon fry as the date of first emergence from the gravel. We designated the date after which mean lengths continuously exceeded 4.5 cm as the date of emergence completion. We chose this criteria because subsequent sampling showed few fry exhibited yolk sacs and mean lengths of fry thereafter increased at a steady rate. Based on the spawning distribution of tagged adults, newly emergent fry of spring chinook salmon were captured only at Sand Hole and High Banks. Newly emergent fry captured at sites farther downstream were the progeny of fall chinook salmon.

We also estimated the mean date of emergence for fry produced by female spring chinook salmon that spawned on 15 September, 1 October, and 15 October in the area just downstream of Lost Creek Dam. We assumed that emergence occurred when fry reached the "button up" stage of fry development, which occurs at about 1,835 temperature units for spring chinook salmon embryos incubated at Cole M. Rivers Hatchery (personal communication dated 20 September 1991 from Michael Evenson, ODFW, Cole M. Rivers Hatchery, Trail, Oregon). We used water temperature data from USGS gages to estimate cumulative temperature units. This procedure may have resulted in estimates of emergence time that were slightly earlier than the actual emergence time because water temperatures within redds can be slightly cooler than the temperature of the stream (Shepherd et al. 1986).

## Abundance

We used catch rates during the 4 weeks that followed emergence completion as an index of fry abundance at Sand Hole and High Banks, the only seining sites within spawning areas used by adult spring chinook salmon. We assumed catch per unit effort was a reliable index of year class strength. To be a reliable index, annual variations in catch rates should reflect annual variations in juvenile abundance. We assumed that annual changes in site morphology, sampling efficiency, and fish behavior accounted for minimal variation in annual catch rates of spring chinook salmon fry.

We believe that seine catches were a valid index of juvenile abundance because chinook salmon inhabit midwater habitat characterized by low water velocity and substrate composed of small particles (Everest and Chapman 1972). Beach seines effectively sample juvenile chinook salmon in this type of habitat (Parsley et al. 1989).

We estimated trap efficiency at Savage Rapids Dam with releases of marked juvenile chinook salmon. We completed four estimates of trap efficiency, two in 1985 and two in 1988. Each release group in 1985 was uniquely marked with a 3mm punch in the caudal fin. In 1988, we uniquely marked release groups with a partial caudal clip and a liquid nitrogen brand.

Mean lengths of fish marked in 1985 averaged 10.4 cm and 10.6 cm, while mean lengths of fish marked in 1988 averaged 9.6 cm and 9.8 cm. We compared mean lengths with paired t-tests and found no differences (all  $P > 0.37$ ) between the four paired groups of released and recaptured fish. These findings suggested there was minimal size selectivity while the trap operated during the mark-recapture experiments. Without trap efficiency estimates for juvenile chinook salmon in the 4-8 cm size range, we were forced to assume that fish size did not affect trap efficiency. Such an assumption is likely erroneous.

Marked fish were released 3 km upstream of the trap. Marked fish that appeared healthy were released while those that appeared stressed were retained. About 6% of the marked fish were not released. We did not evaluate delayed mortality. We fished the trap at Savage Rapids Dam 24 hours daily for 20 days after the release of mark groups. We estimated trap efficiency ( $E$ ) as:

$$E = r/n$$

where

$r$  = number of marked fish recaptured and  
 $n$  = number of marked fish released.

We estimated the confidence interval for trap efficiency estimates under the assumption of finite population with a binomial distribution (Zar 1984).

Results from the mark-recapture experiments indicated that recapture rates decreased with increased rates of river flow (Table 4). However, mark-recapture experiments were completed only over a limited range of flow. Mean flow during the experiments ranged between 1,420 and 2,367 cfs while the trap was fished in 1974-90 at mean weekly flows that ranged between 870 and 6,530



Table 4. Results of four mark-recapture experiments designed to estimate trap efficiency at Savage Rapids Dam. All fish released were subyearling chinook salmon.

Flow at recapture <sup>a</sup>	Number of fish		Proportion recaptured	95% confidence interval	Mean length (cm)
	Released	Recaptured			
2,261	750	15	0.020	0.011-0.033	10.3
2,367	828	12	0.014	0.008-0.025	10.4
1,420	306	17	0.056	0.034-0.086	9.8
1,518	321	13	0.040	0.022-0.069	9.7

<sup>a</sup> Mean flow (cfs) at Grants Pass.

cfs (Appendix Table B-4). Consequently, we were forced to make additional assumptions about trap efficiency in order to estimate the number of juvenile chinook salmon that passed Savage Rapids Dam.

We assumed that trap efficiency was 0.001% at a flow of 8,000 cfs. We included the assumed value with the observed values from the mark-recapture experiments and transformed the data to logits. Regression analysis estimated the relationship between flow and trap efficiency as:

$$\text{proportion trapped (logit transformed)} = -1.0563 - 0.001307 * \text{flow}$$

We used this relationship to estimate trap efficiency each week that the trap at Savage Rapids Dam was fished during 1974-90. Other studies have documented that the relationship between trap efficiency and flow approximates a negative power function (Unwin 1986; Fustish et al. 1988; Lindsay et al. 1989).

We used the mean nightly catch rate for unmarked juvenile chinook salmon (Appendix Table B-5) and marked juvenile chinook salmon that were released from Cole M. Rivers Hatchery in June (Appendix Table B-6) to estimate the number of fish that would have been caught if the trap had been fished seven nights each week. Then, we estimated the number of fish that would have been caught each week if the trap had been fished 24 hours daily by dividing the weekly catch at night by 0.7 because catches during the day accounted for an average of 30.3% (SE = 4.2%) of the juvenile chinook salmon captured during four mark-recapture experiments when the trap fished continuously. Finally, we divided the calculated mean weekly catch by the weekly estimates of trap efficiency to estimate the number of marked and unmarked juvenile chinook salmon that passed Savage Rapids Dam each week.

We estimated the number of unmarked hatchery fish that originated from releases at the hatchery during June by expanding estimates of the number of marked hatchery fish that originated from those releases based on the proportion marked at time of release (Appendix Table B-2). We subtracted estimates of the number of unmarked hatchery fish from passage estimates of all unmarked fish to estimate the number of wild fish that passed Savage Rapids Dam.

## Growth Rate

We analyzed scales taken from juveniles raised in the laboratory (see Laboratory Experiments, page 26) to determine if circuli spacing could be used to estimate growth rates of wild fish in the Rogue River. We found that juvenile spring chinook salmon raised in the laboratory grew at faster rates when fed at greater rates relative to their body weight (Figure 5). Mean lengths of the six groups reared in the laboratory ranged between 8.1 and 11.7 cm when the experiment ended (day 250) and most of the groups differed significantly in mean length (Appendix Table B-7). A summary of mean lengths of fish reared during the laboratory experiment is in Appendix Table B-8.

Most of the six groups raised in the laboratory also differed significantly in width of spaces between circuli (Appendix Table B-9). Circuli spacing was positively related to growth rate for the 179 juveniles sampled at the end of the experiment (Figure 6). Growth rates of individual fish ranged between 0.76 and 4.32 mm/day, assuming that the fish were 4.4 cm long when placed in the tanks during February. A summary of mean circuli spacing estimated for fish reared during the laboratory experiment is in Appendix Table B-10.

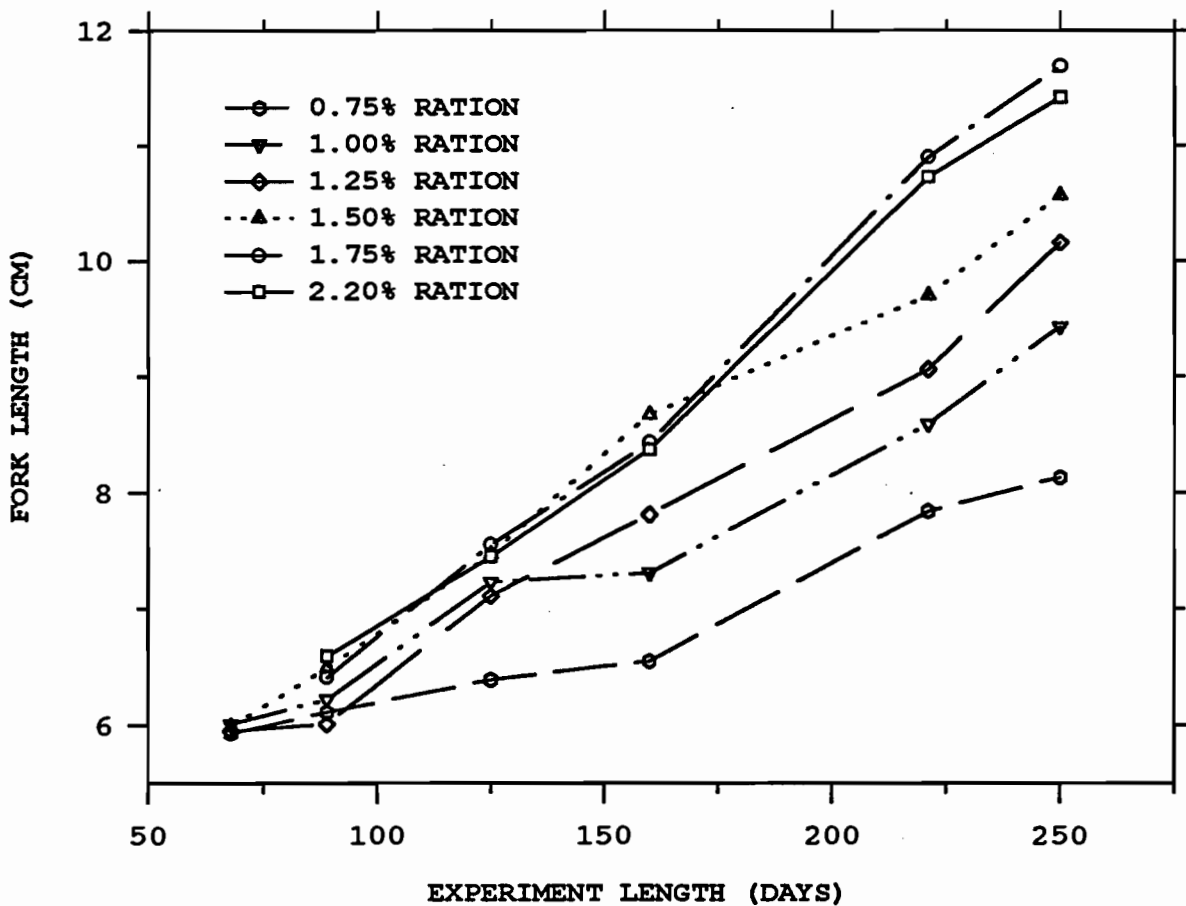

Figure 5. Changes in mean lengths of juvenile chinook salmon reared in the laboratory during 1976. Ration size represents the daily weight of feed expressed as a percentage of the weight of fish within each of the six groups.

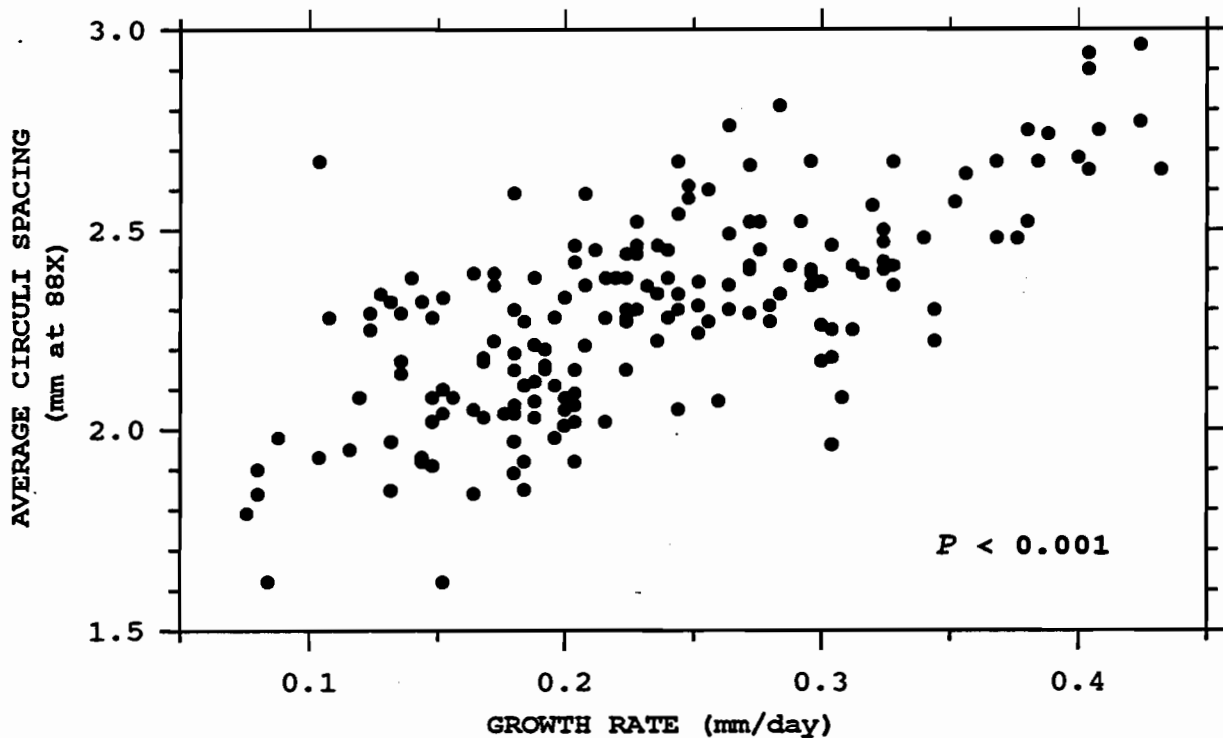

Figure 6. Relationship between the average spacing of scale circuli and the growth rate of juvenile chinook salmon reared in the laboratory during 1976.

A positive relationship between circulus spacing and growth rate has been reported for other species of fish (Bilton and Robins 1971; Doyle et al. 1987), but there is evidence that the relationship may be weak at times (Fukuwaka and Kaeriyama 1997). Fisher and Pearcy (1990) concluded that circuli spacing provides valid comparisons of growth rates for juvenile coho salmon provided that the fish were of similar size and age, and have a common relationship between scale radius and fish length. Based on these findings, we concluded that the mean spacing of circuli could be used to estimate the growth rate of wild juvenile chinook salmon in the Rogue River.

We analyzed scales taken from adult spring chinook salmon trapped at Gold Ray Dam in 1974-94 to estimate the growth rates of wild juvenile spring chinook salmon. We also analyzed scales taken from wild juvenile chinook salmon trapped at Savage Rapids Dam in 1982-85 to estimate the growth of chinook salmon fry in spring and early summer. Scale analysts measured three indexes of freshwater growth by juvenile spring chinook salmon: (1) mean spacing between freshwater circuli, (2) mean distance between circulus 1 and circulus 6 (termed band width I), and (3) mean distance between circulus 6 and circulus 11 (termed band width II). We regressed mean circuli spacing on growth rate of fish raised in the laboratory (Appendix Table B-11) and used the predictive equation to estimate the mean growth rate of wild fish.

#### Age at Ocean Entry

We analyzed scales taken from adult spring chinook salmon trapped at Gold Ray Dam to determine juvenile age at ocean entry. We classified fish as

subyearling or yearling migrants based on the presence or absence of a freshwater annulus. We also estimated the migration timing of subyearlings that passed through the middle river from weekly estimates of the number of juveniles that passed Savage Rapids Dam (see Abundance, page 27).

### Date of Ocean Entry

We analyzed scales taken from juveniles raised in the laboratory (see Laboratory Experiments, page 26) to determine if circuli counts could be used to estimate the date of ocean entry for wild fish migrating from the Rogue River. We found that fish that grew at different rates also differed significantly in the number of circuli deposited on the scales (Appendix Table B-12). A summary of circuli counts on scales of fish reared during the laboratory experiment is in Appendix Table B-13.

We also found a positive correlation between fish length and the number of circuli counted on scales sampled in November (Figure 7), similar to results reported by (Fukuwaka and Kaeriyama 1997). This finding suggested that deposition rates of circuli are more dependent on growth rate than on the age (days of life) of the fish, although other factors also affect the deposition rate of circuli on fish scales (Doyle et al. 1987; Fisher and Pearcy 1990). Based on the results of the laboratory experiments, we concluded that the date of ocean entry could be estimated from scales of adult spring chinook salmon only if a relationship could be established between circuli number and day-of-year when the brood reared in freshwater.

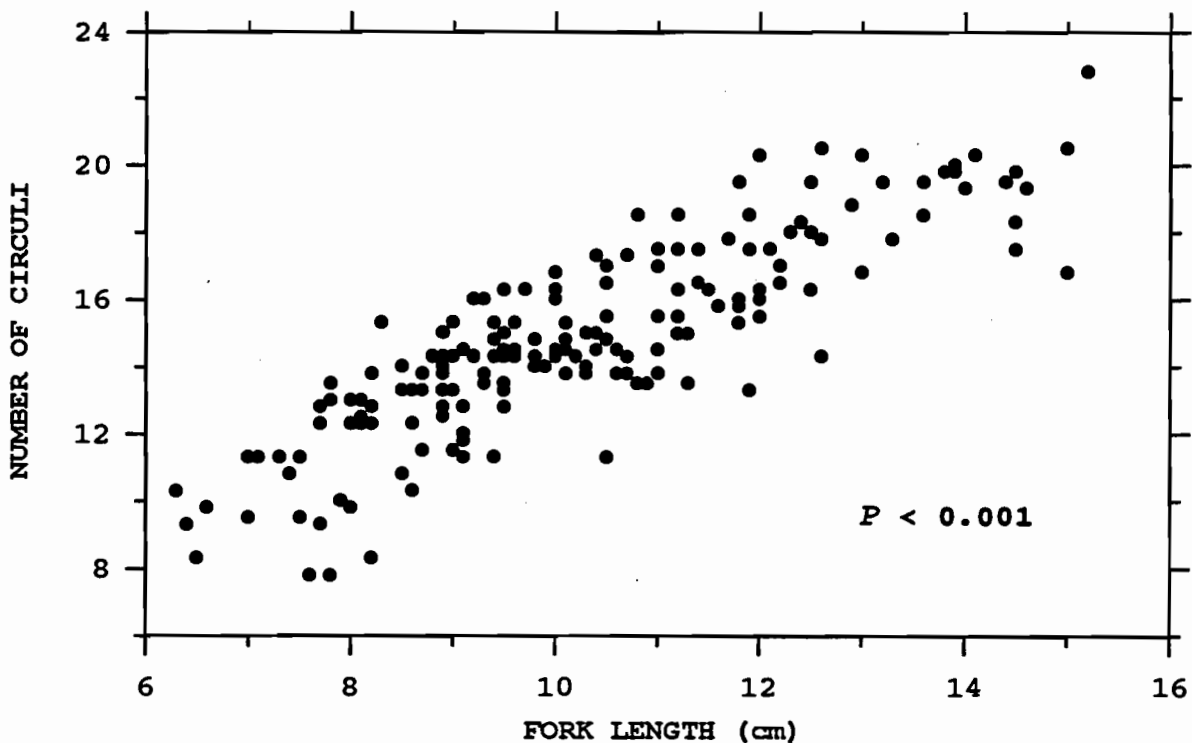

Figure 7. Relationship between the number of scale circuli and the length of juvenile chinook salmon reared in the laboratory during 1976.

We estimated date of ocean entry for subyearling migrants from a combination of data obtained from scales of juveniles and adults that originated from the 1973-80 brood years. We used regression analysis to estimate annual relationships between calendar day of sampling (APPENDIX A) and the number of circuli on the scales of subyearlings seined in the lower river at Canfield. We found that circuli number accounted for an average of 62% of the variation in sampling date among eight regressions developed annually in 1974-81 (Table 5). Circuli numbers were also highly correlated with capture date of juvenile spring chinook salmon in the John Day River, Oregon (Lindsay et al. 1986). Circuli counts to the point of ocean entry on adult scales were inserted into regressions developed to estimate date of ocean entry for subyearling migrants.

We recognize that scale parameters of seined juveniles may not reflect scale parameters of migrants that entered the ocean (Buckman and Ewing 1982). Juveniles seined relatively late in the season, particularly in early autumn, probably grew at slower rates compared with cohorts that migrated at earlier dates. Faster growing juveniles that migrated early would have exhibited fewer freshwater circuli. This type of bias would lead to underestimating the time of ocean entry by several weeks.

Alternatively, time of ocean entry could have been overestimated by several weeks. We believe the saltwater check does not develop on scales immediately upon ocean entry. We assumed the point of ocean entry was characterized by a transition from narrow circuli that were closely spaced to thicker circuli that were widely spaced. One or more evenly spaced circuli may be deposited prior to the formation of a saltwater check.

We concluded that although estimates for time of ocean entry may be biased, estimates of differences among years remained valid because consistent methodologies were employed.

Table 5. Regressions of day-of-year on number of freshwater circuli from scales of subyearling chinook salmon seined at Canfield, 1973-80 brood years. Only scales with more than 10 circuli were included in the regressions.

Brood year	Regression <sup>a</sup>	Standard error	N	r <sup>2</sup>	P
1973	Y = 79.6 + 8.71(X)	0.63	117	0.63	<0.001
1974	Y = 118.3 + 7.43(X)	0.31	194	0.75	<0.001
1975	Y = 86.4 + 9.39(X)	0.62	332	0.41	<0.001
1976	Y = 41.5 + 11.87(X)	0.56	407	0.52	<0.001
1977	Y = 76.9 + 7.83(X)	0.38	241	0.64	<0.001
1978	Y = 71.5 + 9.01(X)	0.37	356	0.63	<0.001
1979	Y = 70.9 + 8.02(X)	0.25	322	0.76	<0.001
1980	Y = 59.4 + 9.17(X)	0.38	366	0.61	<0.001

<sup>a</sup> Y = day-of-year, X = number of circuli.

We previously used pooled regressions from preimpoundment broods to estimate dates of ocean entry for subyearling migrants that reared in fresh water prior to 1974 and used pooled regressions for postimpoundment broods to estimate dates of ocean entry for subyearling migrants that reared in the river after 1981 (Cramer et al. 1985). However, relationships between circuli numbers on scales of juvenile fish and day-of-year were estimated only in 1974-81 so we estimated the date of ocean entry only for those years.

To estimate the date of ocean entry for yearling migrants, we used regression analysis to estimate the relationship between calendar day of sampling (APPENDIX A) and two other variables: fish length and the number of circuli on juvenile scales. We found that these two variables accounted for 50% of the variation in capture dates of yearling chinook salmon trapped at Table Rock in 1975-78. Fish length was positively related to capture date while circuli number was negatively related to capture date (Appendix Table B-14). Circuli counts to the point of ocean entry on adult scales and estimated length at ocean entry were inserted into the regression developed to estimate the date of ocean entry for yearling migrants.

### Length at Ocean Entry

We analyzed scales taken from juveniles raised in the laboratory (see Laboratory Experiments, page 26) to determine if scale radius could be used to estimate the length of wild fish at the time of ocean entry. We found that most of the six groups of fish reared in the laboratory during 1976 differed significantly in scale radius (Appendix Table B-15). A summary of the radius of scales taken from fish reared during the laboratory experiment is in Appendix Table B-16.

We also found that scale radius was positively related to the length of 179 juvenile chinook salmon sampled at the end of the experiment (Figure 8). As the two variables were highly correlated, as found in other studies of salmonids (Fukuwaka and Kaeriyama 1997), we concluded that juvenile length at time of ocean entry could be estimated from scales taken from adult spring chinook salmon that returned to the Rogue River. This conclusion assumes that scale analysts were able to identify the appropriate location on the scale when juvenile fish entered the ocean.

We estimated juvenile length at ocean entry from a combination of data derived from scales of juveniles and adults. We used regression analysis to estimate annual relationships between fork length and scale radius for wild juvenile chinook salmon from the 1973-79 brood years. We found scale radius annually accounted for at least 85% of the variation in fork length for juveniles from the 1973-79 brood years (Table 6).

Analysis of pooled regressions for preimpoundment and postimpoundment broods showed no significant differences among slopes ( $P = 0.825$ ) or elevations ( $P = 0.087$ ). We used a pooled regression from all broods to estimate dates of ocean entry for fish that reared in fresh water prior to 1974 and after 1981. Use of pooled data to estimate relationships for years when juveniles were not sampled for scales may be biased because slopes of annual regressions differed significantly ( $P < 0.001$ ).

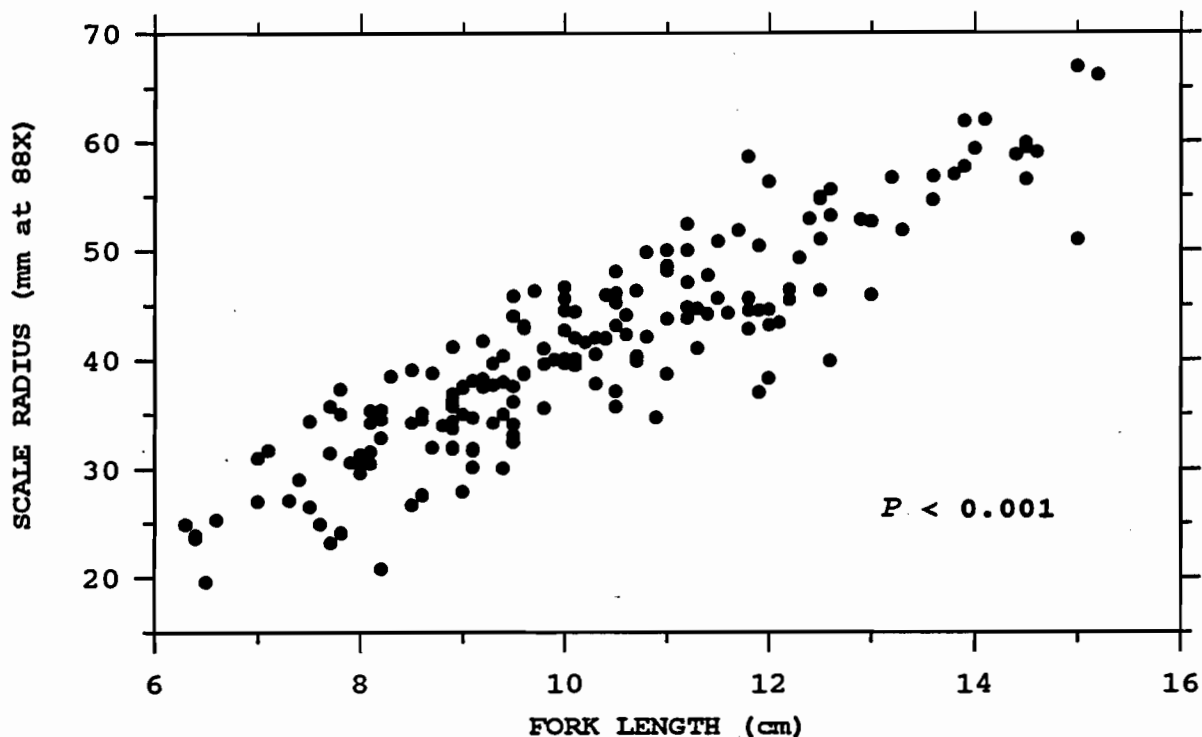

Figure 8. Relationship between the scale radius and the length of juvenile chinook salmon reared in the laboratory during 1976.

Table 6. Regressions of fork length on scale radius for subyearling chinook salmon seined at Canfield, 1973-79 brood years. Only data from fish 5-13 cm in length were included in the regressions.

Brood year	Regression <sup>a</sup>	Standard error	N	r <sup>2</sup>	p
1973	Y = 2.93 + 0.178(X)	0.006	120	0.86	<0.001
1974	Y = 1.87 + 0.206(X)	0.003	260	0.93	<0.001
1975	Y = 2.67 + 0.193(X)	0.003	447	0.88	<0.001
1976	Y = 2.30 + 0.176(X)	0.003	497	0.88	<0.001
1977	Y = 2.29 + 0.188(X)	0.003	318	0.92	<0.001
1978	Y = 2.73 + 0.171(X)	0.004	390	0.85	<0.001
1979	Y = 2.24 + 0.181(X)	0.003	403	0.93	<0.001
1974-79 <sup>b</sup>	Y = 2.52 + 0.181(X)	0.002	2,315	0.88	<0.001

<sup>a</sup> Y = fork length (cm), X = scale radius (mm at 88x).

<sup>b</sup> Regression used to predict length at ocean entry for broods not sampled as juveniles.

## Standardization of Scale Parameters

Over the course of the project, five analysts measured scales taken from adult spring chinook salmon that returned to the Rogue River in 1974-94. We evaluated measurement variability among four of the analysts with a test established from scales of 25 adult spring chinook salmon trapped at Gold Ray Dam in 1980. Return years measured by analysts and dates when measurement tests could be documented are presented in Table 7.

Table 7. Collections of scales from adult spring chinook salmon interpreted by five analysts and dates when scale measurement tests could be documented.

Analyst	Return years measured	Year of measurement test
#2	1977-81	1982
#3	1982-85	1982
#4	1986-88	1986
#5a	1989-93	1992
#5b	1994	1995

We modified results from the measurement tests to include only age 4 fish (18 samples) and analyzed four indexes of freshwater life history: (1) combined widths of circuli bands I and II, (2) average spacing of freshwater circuli, (3) counts of freshwater circuli, and (4) scale radius at ocean entry. Comparisons of each parameter indicated that there were significant differences among analysts (Table 8). We calculated analyst differences for each parameter and weighted estimates of freshwater life history parameters to standardize measurements of readers 3, 4, and 5 to those of reader 2. Measurements made by the various readers are in Appendix Table B-17.

Table 8. Mean measurements (mm at 88x) of four scale parameters of freshwater life history among four scale analysts. Analysts interpreted the same scales that were taken from a test group of 18 age 4 spring chinook salmon. Within rows, means with differing superscripts differed significantly at  $P \leq 0.05$  as estimated with a Newman-Keuls Multiple range test.

Scale parameter	Scale analyst				
	#2	#3	#4	#5a	#5b
Band widths I+II	22.72 <sup>a</sup>	23.14 <sup>a</sup>	21.74 <sup>a</sup>	--	--
Average circuli spacing	2.01 <sup>b</sup>	2.11 <sup>a</sup>	2.04 <sup>b</sup>	2.10 <sup>a</sup>	2.11 <sup>a</sup>
Number of freshwater circuli	19.6 <sup>a</sup>	18.6 <sup>b</sup>	20.7 <sup>a</sup>	19.8 <sup>a</sup>	19.8 <sup>a</sup>
Radius to ocean entry	45.1 <sup>b</sup>	45.2 <sup>b</sup>	47.3 <sup>a</sup>	48.1 <sup>a</sup>	48.3 <sup>a</sup>



## Adults

### Life History

Based on the findings of ODFW (1992), we assumed that chinook salmon that passed the counting station at Gold Ray Dam before 16 August were spring chinook salmon and that chinook salmon that passed Gold Ray Dam after 15 August were fall chinook salmon. We recognize that the date chosen to separate the races of chinook salmon is somewhat arbitrary and so we also pooled data from both races for many analyses.

We trapped spring chinook salmon in 1974-94, and fall chinook salmon in 1986-94, at Gold Ray Dam (RK 202) to obtain scale samples used to determine life history. We trapped once weekly from 1 May through 15 October except we trapped twice weekly in June. We assumed no difference in the catchability for adults of different ages. This assumption would not be appropriate if the trap captured fish in a size selective manner. We also assumed no difference in the catchability of wild and hatchery fish of the same age.

Samplers examined all adults for tags and fin clips, and measured fork length to the nearest 0.5 cm. We increased the annual rate of scale sampling as the proportion of unmarked hatchery fish in the run increased. In 1974-84, samplers collected scale samples from at least 50 fish, when possible, within each 5-cm size interval. In 1985-94, samplers collected scale samples from at least 100 fish, when possible, within each 5-cm size interval. Collection rates within common size intervals were limited to ten scale samples weekly.

Samplers removed about 20 scales from those fish that were sampled. Scales were taken immediately above the lateral line and immediately posterior to the dorsal fin. Four of the larger, non-regenerated scales of regular shape were mounted on gummed cards and impressed on acetate at 100°C under 5,000 psi for 3 minutes.

Scales from a minimum of 30 wild fish, if possible, were measured at a magnification factor of 88. Samplers measured and counted circuli in the anterior region of each scale along the longer of two lines at 20° angles from the longitudinal midline of the scale. Scale measurements included: nucleus center to the nucleus margin, nucleus margin to circulus 6 (termed band width I), circulus 6 to the circulus 11 (termed band width II), circulus 11 to the circulus 16 (termed band width III), circulus 16 to the circulus 21 (termed band width IV), nucleus center to the point of ocean entry, nucleus center to each annulus, and nucleus center to outer edge of the scale. Samplers recorded measurements to the nearest 0.5 mm. Circuli were counted from the nucleus to the judged point of ocean entry, annuli, and the distal edge of the scale.

We estimated the origin and age of adult spring chinook salmon trapped at Gold Ray Dam by scale analysis and the presence or absence of fin clips. Scales were interpreted three times by analysts before final classification of fish life history. All saltwater annuli should have been apparent on the samples because they form by February (Orsi and Jaenicke 1996).

Hatchery fish that originated from the 1968-74 broods years were uniquely marked (Appendix Tables B-1 and B-2) and scales from these fish indicated that no annuli had been absorbed by the time adult spring chinook salmon reached

Gold Ray Dam. We used these scales to train scale analysts on recognition of annuli because these fish were of known age. We also used these scales to train analysts on the recognition of scale parameters that were characteristic of juvenile fish released from the hatchery in December though March.

Few unmarked hatchery fish were released prior to 1976, except as unfed fry (Appendix Tables B-1 and B-2), so we assumed that all unmarked adult fish produced from the 1968-74 brood years were of wild origin. We also assumed that no unmarked age 2 fish of hatchery origin returned to freshwater in 1977 because all unmarked smolts from the 1975 brood year were released in December and none of the Ad-CWT marked smolts, that were released in December, returned to the hatchery as age 2 adults.

Significant numbers of unmarked hatchery fish first returned as age 3 adults in 1978. Scales taken from unmarked adult spring chinook salmon trapped at Gold Ray Dam in 1978-82 were classified by discriminant analysis (Cramer et al. 1985). We used half of the scales collected in 1980-81 from fish of known origin to develop the function. Use of the discriminant function to classify the origin of the remaining scales indicated that 3% of the samples were erroneously classified as either wild or hatchery fish.

The error rate using the discriminant function was similar to the 4% error rate recorded when scale analysts visually classified the same scales from fish of known origin. We believe that scales from unmarked hatchery fish could be readily identified by analysts because none were released prior to October and the fish were at least 15 cm long. In contrast, we estimated that wild fish average 10-12 cm long at time of ocean entry (Cramer et al. 1985). Based on these findings, we decide to visually classify scales collected after 1982 because use of the function would have required that all scales would have needed to be measured.

However, release times of juvenile spring chinook salmon changed at Cole M. Rivers Hatchery in the mid-1980s. Large numbers of unmarked fish were released in June of 1984 and in June of 1986-87 (Appendix Table B-2). In addition, releases of unmarked fish in August and September began in 1985 and continued through 1994 (Appendix Table B-2). The earlier time of release in later years increased the difficulty of differentiating the scales of wild fish and hatchery fish.

In 1992, we developed three additional reference collections of scales taken from spring chinook salmon of hatchery origin. We retrieved and measured the freshwater portion of 113 scale samples taken from LV marked adults that originated from a release in June 1984. These juveniles averaged about 9 cm in length and averaged 8 g in weight at release. We also retrieved and measured the freshwater portion of 87 scale samples taken from Ad-CWT marked adults that originated from a release in August 1986. These juveniles averaged about 13 cm in length, averaged 30 g in weight at release, and were the smallest juvenile spring chinook released in August or September from Cole M. Rivers Hatchery. Finally, we retrieved scales and classified the age of 76 Ad-CWT marked adults that originated from two groups released in October 1976. At release, these groups averaged 15 cm and 19 cm in length, and averaged 42 g and 86 g in weight. A summary of selected scale parameters for each group is in Appendix Table B-18, except that scales from fish released in October 1976 were not measured.

We used the new reference collections of scales from hatchery fish, and a reference collection of scales from wild fish that spawned between Shady Cove and Gold Ray Dam in 1980 and 1981, to test our ability to differentiate scales of wild and hatchery spring chinook salmon. Results from reader tests indicated that the scale analyst who classified the life history of adults that returned in 1983-94 was able to correctly identify the origin of 93-96% of the test scales (Table 9). Based on this finding, we concluded that visual interpretation of scales was an appropriate method to determine the origin of unmarked spring chinook salmon trapped at Gold Ray Dam and used this method to classify the origin of fish from scale samples collected in 1984-94.

Table 9. Results from tests conducted to determine if scale samples could be used to distinguish wild spring chinook salmon from hatchery fish that were released as juveniles in June, August, and October. Only the freshwater portions of scales were visible to the analyst. Scales of wild fish originated from adults that spawned between Shady Cove and Gold Ray Dam in 1980-81. Scales of hatchery fish originated from marked adults that returned to Cole M. Rivers Hatchery.

Date of hatchery release	<u>N in test</u>		<u>N correct</u>		Classification rate
	Wild	Hatchery	Wild	Hatchery	
June 1984	113	113	109	108	96%
August 1986	87	87	81	83	94%
October 1976	75	76	71	70	93%

Visual classification of scale samples appeared to be an effective method to identify unmarked hatchery fish among chinook salmon trapped at Gold Ray Dam. Annual percentages of marked fish among spring chinook salmon that returned to Cole M. Rivers Hatchery were similar to the annual percentages of marked fish among trapped spring chinook salmon subsequently classified as hatchery fish by scale analysts (Table 10). This finding, coupled with the results of classification tests taken by scale analysts, indicated that scale analysis was an effective method to segregate wild and hatchery fish among unmarked chinook salmon trapped at Gold Ray Dam. Other studies have shown that scale interpretations can be used to segregate wild and hatchery chinook salmon with a high degree of reliability (Unwin and Lucas 1993).

We also found that the counter's records and trap catches produced similar estimates of the relative abundance of hatchery fish among chinook salmon that passed Gold Ray Dam in 1974-94 (Appendix Table B-19). Based on this finding, we chose to use the counter's records to estimate the number of marked chinook salmon that passed Gold Ray Dam in 1969-94.

We use the terminology of Gilbert and Rich (1927) to present the age of spring chinook salmon. The first digit represents the years of total life or years of life at maturity. The second digit represents the year of life at time of ocean entry. For example, an age 4<sub>1</sub> chinook salmon is in the fourth year of life and migrated to the ocean as a subyearling.

Table 10. Percentage of spring chinook salmon that exhibited marks among hatchery fish trapped at Gold Ray Dam and among fish that returned to Cole M. Rivers Hatchery, 1980-94. Unmarked hatchery fish trapped at Gold Ray Dam were identified by scale analysis.

Return year	% marked		Return year	% marked	
	Trap	Hatchery		Trap	Hatchery
1980	29.0	32.0	1988	20.5	14.7
1981	31.1	37.9	1989	11.1	11.4
1982	31.1	36.2	1990	8.1	9.9
1983	37.9	38.8	1991	4.2	8.2
1984	34.5	39.6	1992	5.0	7.0
1985	33.2	43.8	1993	7.4	8.4
1986	28.6	32.0	1994	6.4	8.3
1987	22.5	24.9			

### Abundance

**Freshwater Return:** The annual freshwater return of spring chinook salmon was estimated as the sum of (1) the number of spring chinook salmon that passed the counting station at Gold Ray Dam, (2) freshwater harvest downstream of Gold Ray Dam, and (3) prespawning mortality downstream of Gold Ray Dam.

We also estimated the annual freshwater return of fall chinook salmon destined to pass Gold Ray Dam using a method similar to that used for spring chinook salmon. We used the age composition of fall chinook salmon sampled near the mouth of the Rogue River in 1974-85 (ODFW 1992) to estimate the age composition of fall chinook salmon that passed Gold Ray Dam. We estimated the number of fish that died downstream of Gold Ray Dam from rates of prespawning mortality reported by ODFW (1992) for the years 1974-86 and by Fustish et al. (1994) for the years 1986-87. We assumed a prespawning mortality rate of 0.5% for the years 1988-94 because few fall chinook salmon died during those years. We estimated the number of fish harvested in the Rogue River downstream of Gold Ray Dam from harvest rates reported by ODFW (1992) for the years 1974-86 and assumed an annual harvest rate of 10% for the years 1987-94.

Passage of chinook salmon at Gold Ray Dam has been estimated since 1942. All fish were counted during 1942-47. During 1948-92, fish were counted eight hours daily, five days weekly. Partial counts were designed to estimate biweekly passage with an average error of less than 10% (Li 1948). Since 1993, passage has been estimated with video recordings, which has been shown to be accurate in at least one application (Hatch et al. 1994).

In 1942-68, fish were counted as they passed above a white board. Since 1969, fish have been counted as they passed an underwater viewing window. Counters also recorded fin clips and classified fish by size. Counters classified chinook salmon as jacks if fish were less than 20 inches (50 cm) in 1942-77 or less than 24 inches (60 cm) in 1978-86.

Mark rates among spring chinook salmon that returned in 1953-65 were assumed to be equal to the percentage of marked fish among spring chinook salmon processed at canneries near Gold Beach in 1953-65 (Appendix Table B-20). Although some smolts of hatchery origin were released downstream of Gold Ray Dam, the proportion of marked fish in the canneries did not differ significantly from the proportion of marked fish at sampling sites upstream of Gold Ray Dam in 1956 or in 1965. In 1956, 3 of 210 fish (1.4%) of the spring chinook salmon trapped in Big Butte Creek exhibited hatchery marks while 1.1% of the cannery fish were marked (Appendix Table B-20). In 1965, surveyors found 74 marks among 1,100 (6.7%) spawned carcasses of spring chinook salmon found upstream of Gold Ray Dam while 4.9% of the cannery fish were marked. These two comparisons suggested that most adult spring chinook salmon of hatchery origin returned to the upper river even though some fish were released as smolts as far downstream as the head of tidewater.

**Ocean Abundance:** We used cohort analysis (Ricker 1975) to estimate the number of wild and hatchery spring chinook salmon that resided in the ocean during spring prior to the maturation of any portion of the cohort. Estimation procedures began with age 6 fish and ended with age 2 fish. Estimates of cohort abundance began with age 6 fish because all spring chinook salmon matured at ages 2-6. The abundance of younger cohorts were estimated as the sum of (1) the number of fish that resided in the ocean during the succeeding year, (2) natural mortality, (3) harvest in the ocean fisheries, and (4) the number of fish that returned to the river. For each cohort, we used the equation

$$N_i(t) = ((N_{i+1}(t+1)/(1 - A_i))/(1 - u_i(t)) + E_i(t)) \quad (2)$$

where

- $N_i(t)$  = number of age  $i$  fish resident in the ocean prior to fishing and freshwater return during year  $t$ ,
- $N_{i+1}(t+1)$  = number of age  $i+1$  fish resident in the ocean during the next year,
- $A_i$  = rate of natural mortality for age  $i$  cohorts resident in the ocean after the fishery, between years  $t$  and  $t+1$ ,
- $u_i(t)$  = exploitation rate of age  $i$  fish in the ocean during year  $t$ , and
- $E_i(t)$  = freshwater return of age  $i$  fish during year  $t$ .

We made no attempt to estimate sources of error associated with cohort reconstruction. We were unable to reconstruct all broods because some cohorts remained in the ocean after termination of sampling in 1994. More thorough discussions of cohort analyses can be found in Pope (1972), Ricker (1975), Hankin and Healey (1986), Kope (1987), and Hankin (1990).

We assumed that natural mortality occurred after termination of ocean fisheries and maturation of a portion of the cohort. Ricker (1975) termed this scenario as a type 1 fishery. We also assumed that all maturing spring chinook salmon entered the river before the initiation of ocean harvest. This assumption seems reasonable as few age 5 Ad-CWT marked fish were harvested in the ocean in years when no age 6 Ad-CWT fish returned to Cole M. Rivers Hatchery in the succeeding year. We assumed a 50% rate of natural mortality in the ocean for age 2 fish and a 20% rate of natural mortality for older fish (Ricker 1976; Healey and Heard 1984).

We also assumed that there was no difference in ocean harvest rate between wild and hatchery spring chinook salmon of the same age. An unknown

amount of error is associated with this assumption. For example, Labelle et al. 1997) found that coho salmon of hatchery origin tended to be harvested at greater rates in the ocean fisheries as compared to wild counterparts produced in proximal areas. However, because we did not Ad-CWT mark any wild spring chinook salmon, we were forced to assume no difference in ocean harvest rates among cohorts of wild and hatchery origin.

The El Niño event of 1982-83 increased complexity of the cohort analysis. Fish resident in the ocean during El Niño grew at slower rates compared with counterparts that reared in the ocean during earlier years (Satterthwaite et al. 1985). We also found that the body condition of mature fall chinook salmon was less in 1983 compared with prior years. Adults that averaged 80 cm in length weighed an average of 7.4 kg (95% CI = +1.4 kg) in 1974-76, but averaged only 6.6 kg (95% CI = +2.0 kg) in 1983. Freshwater returns of fall chinook salmon in the Rogue River during 1983 and 1984 were also much lower than expected (ODFW 1992). These findings suggested that rates of natural mortality probably increased as a result of the El Niño event of 1982-83.

However, estimation of changes in mortality rates for chinook salmon was difficult to quantify because maturity rates may have also changed. Delayed maturity could account for freshwater returns that are less than predicted for chinook salmon, but sampling of freshwater returns in years after the El Niño event of 1982-83 did not suggest that fish matured at older ages. These findings led us to conclude that rates of ocean mortality increased as a result of the El Niño event of 1982-83.

We compared estimates and predictions of cohort abundance in the ocean to estimate changes in mortality rates that resulted from the El Niño event of 1982-83. Predictions were generated from regressions of ocean abundance on freshwater returns of cohorts in the previous year. For each age class, freshwater returns in 1982 were substituted into regressions to predict cohort abundance in the ocean during 1983. We used catch rates of juveniles seined in the Rogue River during the previous year to predict the ocean abundance of age 2 fish.

We believe that the estimates of ocean abundance were less affected by errors in estimates of maturity rates compared with errors in estimates of survival rates. We also believe that the adjustment of survival rates for fish in the ocean resulted in more accurate estimates of fish abundance in the ocean prior to the El Niño event of 1982-83 compared with the alternative assumption of constant rates of survival.

We used the same methods to estimate the abundance of fall chinook salmon (for those fish destined to spawn upstream of Gold Ray Dam) except that we assumed that fish maturing in a given year were subjected to fishing mortality at a rate that was one-half of the fishing mortality rate for cohorts that remained in the ocean.

**Spawning Escapement:** We estimated the number of spring chinook salmon that spawned naturally by subtracting estimates of (1) prespawning mortality, (2) fishery harvest, and (3) returns to Cole M. Rivers Hatchery from estimates of the number of fish that passed Gold Ray Dam. We assumed that no fall chinook salmon were harvested or died prior to spawning after passing Gold Ray Dam.

We also indexed spawning escapement by surveying carcasses of chinook salmon that spawned in areas upstream of Gold Ray Dam (Table 11). We used driftboats to survey the Rogue River. We surveyed alternate banks of the channel on succeeding weeks, except we surveyed every week in areas where carcasses tended to concentrate. We also walked the lower 2 km of Big Butte Creek each week. Few chinook salmon spawned farther upstream because of a waterfall that usually blocked fish migration during early autumn. As we surveyed all spawning areas used by chinook salmon that pass Gold Ray Dam, and because flow and turbidity varied little during September and October, we believe that the number of carcasses recovered was a good index of the number of spawners (Cousens et al. 1982; Shardlow et al. 1987).

We retrieved almost all of the carcasses observed during surveys. We cut all carcasses in half to (1) verify the sex of the fish, and (2) prevent carcasses from being counted during succeeding surveys. We checked each carcass for tags or clipped fins and classified fish less than 60 cm as jacks.

### Age at Maturity

Scale analyses indicated that spring chinook salmon matured at ages 2-6. Consequently, we assumed the probability of maturation was 1.0 at age 6. Maturation probabilities for other age classes were estimated as

$$Q_i = E_i/S_i \quad (3)$$

where

$Q_i$  = probability of maturation at age  $i$ ,  
 $E_i$  = number of fish that returned to the Rogue River at age  $i$ , and  
 $S_i$  = number of fish estimated in the ocean at age  $i$  prior to freshwater return of any maturing fish.

Table 11. Areas surveyed for chinook salmon that spawned in the Rogue River Basin upstream of Gold Ray Dam, 1974-94.

Survey area	RK	Survey period	Years surveyed
Touvelle Park to Gold Ray pool	205-212	09/24-11/18	1974-81, 1986-87
Dodge Bridge to Touvelle Park	212-223	09/24-11/18	1974-81, 1986-87
Shady Cove to Dodge Bridge	223-235	09/24-11/18	1974-81, 1986-87
Rogue Elk Park to Shady Cove	235-245	09/17-11/18	1974-81, 1986-90
Hatchery to Rogue Elk Park	245-252	09/17-11/18	1974-94
Sand Hole Channel	252	09/17-11/18	1974-94
Big Butte Creek <sup>a</sup>	0-2	09/17-11/18	1974-81, 1986-87

<sup>a</sup> Enters the Rogue River at RK 250.

Estimates of maturation rates represent both sexes of chinook salmon because we were unable to distinguish the sex of fish trapped at Gold Ray Dam. However, scales taken from spawned carcasses indicated that all age 2 fish were male. Scales taken from spawned carcasses of known spring chinook salmon indicated that almost all age 3 fish were male. In contrast, scales taken from spawned carcasses of known fall chinook salmon indicated that many were female.

We sampled scales from fall chinook salmon that passed Gold Ray Dam only during 1986-94. We assumed that the age composition of wild fish in earlier years was similar to the age composition of fall chinook salmon that entered the Rogue River (ODFW 1992).

### Ocean Harvest

We estimated the number of wild spring chinook harvested in the ocean fisheries from cohort analyses described in *Abundance in the Ocean*, page 106. Estimates of annual harvest were the product of age-specific estimates of cohort abundance in the ocean prior to opening of the fisheries and estimates of age-specific exploitation rates for Ad-CWT spring chinook salmon released from Cole M. Rivers Hatchery. We assumed that wild and hatchery fish of the same age were harvested at the same rates in the ocean fisheries. Wild fish may actually be harvested at slightly greater rates than hatchery fish because wild fish return to freshwater later than cohorts of the same age (see *Migration Timing*, page 157). However, the virtual absence of age 5 Ad-CWT fish in the ocean harvest suggested that almost all maturing wild and hatchery spring chinook salmon entered the Rogue River before harvest began in the ocean fisheries.

The small numbers of tag recoveries for age 5 Ad-CWT spring chinook salmon in the ocean harvest, coupled with the small numbers of age 6 Ad-CWT spring chinook salmon that returned to Cole M. Rivers Hatchery, it difficult to estimate exploitation rates of age 5 fish in the ocean fisheries. Consequently, we assumed age 5 fish were harvested in the ocean at the same rate as age 4 fish.

### Ocean Harvest Rates

We used cohort assessments to estimate annual rates of ocean harvest for groups of Ad-CWT marked spring chinook salmon released from Cole M. Rivers Hatchery in 1976-90. Estimation procedures began with age 6 fish that returned to the hatchery. Estimates of cohort abundance began with age 6 fish because all spring chinook salmon matured at ages 2-6. The abundance of younger cohorts were estimated as the sum of (1) the number of fish that resided in the ocean during the succeeding year, (2) natural mortality, (3) harvest in the ocean fisheries, and (4) the number of fish that returned to the river. For each cohort, we used the equation

$$N_i(t) = ((N_{i+1}(t+1)/(1 - A_i))/(1 - u_i(t)) + E_i(t)) \quad (2)$$

where



$N_i(t)$  = number of age  $i$  fish resident in the ocean prior to fishing and freshwater return during year  $t$ ,  
 $N_{i+1}(t+1)$  = number of age  $i+1$  fish resident in the ocean during the next year,  
 $A_i$  = rate of natural mortality for age  $i$  cohorts resident in the ocean after the fishery, between years  $t$  and  $t+1$ ,  
 $u_i(t)$  = exploitation rate of age  $i$  fish in the ocean during year  $t$ , and  
 $E_i(t)$  = freshwater return of age  $i$  fish during year  $t$ .

Numbers of Ad-CWT fish that returned to the hatchery were obtained from Michael Evenson, ODFW, Central Point, and estimates of the number of Ad-CWT fish landed in the ocean fisheries were obtained from Mark Lewis, ODFW, Corvallis. We estimated the number of fish harvested in freshwater and the number that died naturally from the results of other analyses (see Prespawning Mortality, page 162 and Harvest Rate, page 196).

We estimated non-harvest fishing mortality in the ocean (shaker mortality) with information supplied by the Klamath River Technical Advisory Team (personal communication received 8 August 1996 from Steven Jacobs, ODFW, Corvallis, Oregon). Mortality of age 3 shakers was estimated as the ocean harvest of age 3 fish multiplied by (1) 0.2 to account for fish released because they were too small to be legally retained and (2) 0.25 to account for mortality of released fish (Wertheimer 1988; Wertheimer et al. 1989). Mortality of age 2 shakers was estimated as the number of age 2 fish resident in the ocean multiplied by the contact rate and a 25% mortality rate for released fish. Contact rate was estimated as 40% of the exploitation rate on age 4 fish.

As recommended by Hankin (1990), we excluded estimates of ocean harvest rates from tag groups that produced few fish. We used estimates of harvest rates for age 4 fish when we estimated that at least 50 age 4 fish were alive after partial maturation of the cohort and before ocean harvest began. We used the same methods to selectively chose harvest rate estimates for age 3 fish except the criterion was 200 fish rather than 50 fish.

Harvest rates of age 3 fish could not be estimated prior to 1978 (1979 for age 4 fish) because no Ad-CWT groups were present in the ocean. We assumed that harvest rates in previous years were the mean of harvest rates estimated for the ocean fisheries in 1978-82 (1979-82 for age 4 fish).

### Migration Timing

We tagged spring chinook salmon seined and electrofished in the lower river during 1974-76, and also tagged spring chinook salmon trapped at Gold Ray Dam in 1974-81 and in 1986-87. We used individually numbered Floy t-bar tags, except we used colored, unnumbered, Floy t-bar tags at Gold Ray Dam in 1977-81. Tag colors were changed weekly. Floy tags were inserted so the t-bar wedged between the pterygiophore bones located below the dorsal fin.

We estimated the migration timing of jacks and adult spring chinook salmon from twice monthly estimates of fish passage at Gold Ray Dam. Separate estimates of migration timing could not be developed for wild and hatchery fish because in most years, only a small proportion of the hatchery fish were marked with fin clips.

We indexed the migration timing of wild and hatchery spring chinook salmon in 1974-94 as the date that fish were trapped at Gold Ray Dam. Date of capture was estimated only for those fish with the origin and age identified by scale analysis. Estimates of migration timing developed by this method are biased because sampling rates for scales were stratified by fish size and spring chinook salmon of each age pass Gold Ray Dam at differing times. Fish trapped during weeks when few fish migrated were more likely to be scale sampled as compared to fish trapped during weeks when many fish migrated.

### Prespawning Mortality

We surveyed the Rogue River canyon, usually on alternate weeks, from 1 May through 31 July in 1975-81. During periods of extensive mortality, we conducted weekly surveys. We also surveyed in 1987, 1992, and 1994 after receiving reports of dead or dying spring chinook salmon in the Rogue River canyon. Surveyors examined carcasses in 1975-81 but not in later years.

We surveyed between Touvelle Park (RK 212) and Shady Cove (RK 235) weekly during June-August in 1977-81 and surveyed between Shady Cove and Cole M. Rivers Hatchery (RK 253) weekly during July-August in 1977 and in 1988-90. In all survey areas, we classified carcasses less than 60 cm long as age jacks while larger fish were classified as adults. We examined carcasses that could be recovered for tags and fin clips.

We cut carcasses in half during 1975-79 to avoid counting mortalities more than once. In 1979, we evaluated the need to cut carcasses in the canyon. Results indicated carcasses disappeared or decomposed prior to surveys in succeeding weeks. During 1980-94, we counted only those carcasses that appeared freshly dead, or where the majority of flesh was present.

We interpolated data to estimate carcass counts during weeks not surveyed to make survey results comparable between years. Because we counted few carcasses during surveys on alternate weeks compared with weekly surveys, expansion of data for weeks not surveyed did not appreciably change carcass counts for years with low mortality. We extrapolated data based on the timing of prespawning mortality in years when the timing of mortality seemed most comparable to years when prespawning mortality began prior to the start of surveys.

We used counts of carcasses in the Rogue River canyon to estimate the number of spring chinook salmon that died downstream of Gold Ray Dam. We used data from fall chinook salmon (ODFW 1992) to develop two relationships between carcass counts in the Rogue River canyon and estimates of total prespawning mortality (Table 12). We segregated years of low and high mortality among fall chinook salmon and regressed estimates of total mortality on carcass counts. We believe that relationships developed for fall chinook salmon could also be used for spring chinook salmon because survey methods were the same for both races of fish.

To evaluate the reliability of our estimates of prespawning mortality in the canyon, we tested the hypothesis that the abundance of fall chinook salmon in the region covaried with the abundance of spring chinook salmon in the Rogue River, and that prespawning mortality among spring chinook salmon could

Table 12. Regressions of the number of fall chinook salmon that died prior to spawning on the number of unspawned carcasses recovered annually in the Rogue River canyon, 1975-86. Data in the regressions were reported by ODFW (1992).

Carcass count	<i>N</i>	<i>r</i>	<i>P</i>	intercept	slope
<200	7	0.99	<0.001	0.758	14.088
>200	5	0.99	<0.001	2,331	12.367

be estimated from deviations in the relationships. We regressed the number of wild spring chinook salmon estimated to pass Gold Ray Dam on cohorts of the same age (1) recovered as spawned carcasses in surveys of the Rogue River Basin conducted in 1978-94 and (2) estimated to have spawned naturally in the Klamath River Basin in 1981-94. Data from spawning surveys for fall chinook salmon in the Rogue River Basin were received from Steven Jacobs, Oregon Department, ODFW, Corvallis, 28 February, 1996. Data from estimates of natural spawning by fall chinook salmon in the Klamath River Basin were received from Richard Dixon, California Department of Fish and Game, Rancho Cordova, on 4 April, 1996.

We used a more direct approach to estimate the number of spring chinook salmon that died in the upper river prior to spawning. First, we estimated of the number of carcasses that would have been found if weekly surveys had covered the entire area upstream of Gold Ray Dam. Second, we estimated the proportion of carcasses recovered during annual surveys.

We assumed that all prespawning mortalities recovered during surveys were spring chinook salmon, that fish died only in the mainstem, and that the distribution of mortality did not differ annually within the area upstream of Gold Ray Dam. The area between Touvelle Park and Gold Ray Dam (9.2 km) was not surveyed in any year so we assumed that the density of carcasses was the same as in the area between Shady Cove and Touvelle Park (24.1 km). We multiplied the number of carcasses found between and Shady Cove and Touvelle Park by 0.382 (9.2/24.1) to estimate the number of carcasses that would have been found had surveys been conducted between Touvelle Park and Gold Ray Dam.

We used the ratio of carcasses found in the 1977 surveys from Cole M. Rivers Hatchery to Shady Cove and from Shady Cove to Touvelle Park to estimate the number of carcasses that would have been found if the upstream area had been surveyed in 1978-81 and if the downstream area had been surveyed in 1988-90. Carcass counts from 1977 indicated that there were 1.10 times as many carcasses in the upstream area than in the downstream area.

We estimated the number of spring chinook salmon that died annually in June-August by dividing expanded estimates of carcass counts by estimates of rates at which carcasses were annually recovered. We estimated the proportion of carcasses recovered annually by dividing the number of carcasses found in prespawning and spawning surveys by the number of chinook salmon estimated to remain in the river. The number of fish that remained in the river was estimated by subtracting hatchery returns and fish harvested in the upper

river from the number of fish that passed Gold Ray Dam. Recovery rates could only be estimated for 1977-81 when spawning surveys were conducted in all areas upstream of Gold Ray Dam. We assumed that recovery rates of carcasses in 1988-90 were the mean of estimates for 1978-81.

Recovery rates of carcasses could only be estimated for fish  $\geq 60$  cm because harvest estimates were not available for smaller fish. In addition, because recovery rates of small salmon are lower than those for large salmon (Solazzi 1984; Fustish et al. 1994), we were unable to estimate the number of spring chinook jacks that died prior to spawning. Consequently, we assumed that rates of prespawning mortality did not differ among different age classes of spring chinook salmon. This assumption is probably erroneous because different ages of spring chinook salmon are exposed to different environmental conditions because of differences in migration timing in freshwater (see Migration Timing, page 157).

Mark rates among unspawned spring chinook salmon were assumed to be the same each year for carcasses in the area between Touvelle Park to Gold Ray Dam as for carcasses in the area between Shady Cove and Touvelle Park. We assumed that mark rates for carcasses in the area between Shady Cove and Touvelle Park during 1988-90 were equal to the mark rates among carcasses recovered between Cole M. Rivers Hatchery and Shady Cove. We believe this assumption to be reasonable because all returning adults of hatchery origin were released at Cole M. Rivers Hatchery and wild fish no longer dominated among fish that entered the hatchery.

In 1977-81, some spring chinook salmon of hatchery origin originated from fish released at sites downstream of Cole M. Rivers Hatchery and wild fish dominated returns to the hatchery. Consequently, we used the ratio of marked fish within each of the survey areas upstream and downstream of Shady Cove to estimate the mark rate among unspawned fish that died between the hatchery and Shady Cove. Estimates were only available for 1977 when marked fish accounted for 15.7% of the prespawning mortalities recovered between the hatchery and Shady Cove and for 28.9% of the mortalities recovered between Shady Cove and Touvelle Park.

### Spawning Distribution and Timing

Survey methods for spawned carcasses were previously described (see Spawning Escapement:, page 41). We indexed the spatial distribution of spawners as the proportion of carcasses counted within each survey area for those years when we surveyed the entire area upstream of Gold Ray Dam.

We tagged chinook salmon that passed Gold Ray Dam with individually numbered tags. In 1974-78 and 1987, we used Floy t-bar tags and in 1986 we used aluminum jaw tags. We also tagged adults during 1979-81, but we chose not to analyze these data because the tags were not individually numbered and were color-coded by 2-week intervals.

We recovered tags during weekly surveys for spawned carcasses in areas upstream of Gold Ray Dam. Upon recovery of a tag, surveyors recorded the date and the river kilometer of the recovery site. We assumed that tagged fish spawned in close proximity to the recovery site.

We estimated the spawning time of wild female spring chinook salmon from weekly counts of carcasses without fin clips. We assumed that unmarked females of hatchery origin did not bias the data. This assumption appeared reasonable because hatchery fish usually accounted for less than 10% of the carcasses recovered during surveys of spawned carcasses.

We also assumed that carcasses were counted 2 weeks after spawning occurred. This assumption was based on a postspawning longevity of 9 days (van den Berghe and Gross 1986) and a postmortem period of 5 days until discovery by a surveyor. A postmortem period of 3.5 days would have been appropriate if all areas were surveyed weekly. However, because some areas were surveyed on alternate weeks, we selected 5 days as an approximation of the postmortem period. The assumption of 9 days as a period of postspawning longevity may be erroneous as McPhee and Quinn (1998) found that early spawning sockeye salmon lived longer than later spawning counterparts.

We grouped data from unmarked carcasses of spawned females into broods produced before and after reservoir operation. Because almost all wild females matured at age 4 or age 5, females counted during 1974-79 were designated as preimpoundment broods and females counted during 1981-87 were designated as postimpoundment broods. We grouped data from females that spawned during 1980 with preimpoundment broods because age 5 adults were twice as abundant as age 4 adults.

We used the spawning time of females that entered Cole M. Rivers Hatchery as a statistical control. Most of the females that entered the hatchery during 1975-77 were wild fish. By 1979, returning females were mostly of hatchery origin. During all years, hatchery personnel randomly selected adults to spawn. Consequently, spawning time at the hatchery should accurately reflect spawning time had the adults been allowed to spawn naturally (telephone conversation on 20 February 1990 with Michael Evenson, ODFW, Cole M. Rivers Hatchery, Trail, Oregon).

We made no attempt to estimate the quantity or quality of physical habitat available to either juvenile or adult spring chinook salmon. We assumed that temporal variations in channel morphology, and physical characteristics of the substrate, had no influence on either spawning time or spawning distribution during the study. We recognize that the habitat of spring chinook salmon is a dynamic, rather than static, variable. However, other than water quality, we lacked the data necessary to evaluate temporal changes in habitat.

### Freshwater Fisheries

We used four sources of data to evaluate angler catch and effort for spring chinook salmon: (1) records from canneries that operated in the lower river during 1950-64, (2) angler surveys conducted in the lower river during 1965-76, (3) angler surveys conducted as part of this project in 1977-83, (4) angler surveys conducted in the upper river during 1987-90, and (5) harvest estimates from salmon-steelhead cards returned by anglers.

In 1950-64, most spring chinook salmon harvested in the lower river were processed in canneries near Gold Beach. Biologists with the Oregon State Game Commission obtained records of the number of spring chinook salmon processed

at each cannery and interviewed anglers to estimate the proportion of fish annually taken to canneries (personal communication on 15 August, 1983, with Arvo Riikula, ODFW, Gold Beach, Oregon).

The Oregon State Game Commission also surveyed anglers that fished for spring chinook salmon in lower river during 1965-76. We concluded that there was sufficient data to estimate angler catch rates and angler effort on an annual basis all years except 1969 and 1974. Anglers were interviewed 3-5 times weekly in April-May from tidewater (RK 5) to Hideaway (RK 24). A survey clerk counted bank anglers and boats in the same area three times daily from the road. We treated the effort counts as indexes because no sampling was conducted to estimate numbers of bank anglers and boats in areas not visible from the road.

In 1977-83, we surveyed anglers in five areas of the Rogue River (Table 13). These surveys were designed to estimate angler catch rates and to index angler effort. While interviewing anglers, survey clerks followed a circular route designed to encompass the entire area. Route direction and starting point on either ends of the survey areas were randomly selected. Anglers were asked how long they had fished and if they had landed fish. Data were recorded only from those bank and boat anglers that were randomly encountered.

Fish retained by anglers were identified by species, examined for identifying marks, and classified by fork length. Spring chinook salmon smaller than 60 cm (50 cm in 1977) were classified as jacks. Larger fish were classified as adults. When fish could not be examined by survey clerks, anglers were queried about the number landed, species, and the size of fish. Fish were recorded as unexamined jacks or unexamined adults if the clerk was not able to examine the fish. We assumed that anglers relayed accurate information on hours fished, number of fish captured, and fish size.

Clerks could identify spring chinook salmon of hatchery origin only if a fin clip was present. Clerks obtained scale samples from unmarked fish harvested in the lower river during 1979-81 and in the upper river during 1980-81. Scale analysts estimated the age and whether the fish were of wild or hatchery origin. Analysts interpreted scales from all jacks and all adults sampled in the lower river fishery. Analysts interpreted 200-400 randomly chosen scales from adults and from all jacks sampled in each of the two areas surveyed in the upper river.

Table 13. Surveys of recreational fisheries for spring chinook salmon in the Rogue River, 1977-90.

Survey area	RK	Period	Years
Tidewater to Bradford Creek	5-28	04/01-06/15	1977-81
Pierce Riffle to Savage Rapids Dam	171-173	05/01-06/10	1982-83
Touvelle Park to Shady Cove	212-235	05/15-07/31	1978-81
Dodge Bridge to Shady Cove	223-235	05/07-07/31	1987-90
Shady Cove to Cole Rivers Hatchery	235-253	05/07-07/31	1977-81, 1987-90

Methods to index angler effort differed between survey areas. In the RK 5-28 survey area, clerks counted bank anglers and boats at 0800 hours, 1000 hours, and 1630 hours. These times were chosen to conform to effort counts conducted in 1966-76. Each count began at either tidewater or Bradford Creek, whichever was closest for the clerk. Clerks counted from the road on the north bank of the Rogue River between tidewater and Lobster Creek (RK 18) and from the road on the south bank of the Rogue River between Lobster Creek and Bradford Creek.

In the RK 171-173 survey area, clerks counted only boats at 0800 hours and 1100 hours. The entire area could be seen from stops at Pierce Riffle Park and Savage Rapids Dam. In the RK 212-235 survey area, clerks counted only boat trailers at 0900 hours, 1400 hours, and 1900 hours. Each count began Touvelle Park and proceeded upstream along the north bank of the Rogue River. In the RK 235-253 survey area, clerks counted bank angler and boats at 0900 hours, 1400 hours, and 1900 hours. In 1980-81, survey clerks also counted boat trailers. Each count began at Shady Cove and proceeded upstream along the north bank of the Rogue River.

Survey schedules also differed between survey areas. In the RK 5-28 survey area, clerks worked four days weekly that were randomly chosen except that clerks did not work on Tuesdays or holidays. Anglers were interviewed from 0800 hours to 1700 hours. In the RK 171-173 survey area, clerks surveyed only those boat anglers encountered after the boat counts at 0800 hours and 1100 hours. Clerks surveyed five days weekly that were randomly chosen.

In the RK 212-235 and RK 235-253 survey areas, survey clerks worked five days each week, except for weeks with holidays. Sampling days were stratified so that each day of the week was sampled about the same number of times each month. Days were divided into three time strata: 0600-1100 hours, 1100-1600 hours, and 1600-2100 hours. Survey clerk surveyed two of three time strata that were randomly chosen. Angler interviews began one hour after the start of a time strata.

In 1987-90, we surveyed anglers who fished for spring chinook in two areas of the upper river (Table 13). Survey methods were the same as methods employed when these areas were surveyed in 1977-81 except that the clerk surveyed both weekend days and two randomly chosen week days during each week. Angler interviews began at 0900 hours and continued until 2000 hours. We also periodically counted boats from an airplane at the same time clerks counted boat trailers from the road (Satterthwaite et al. 1992). In addition, the clerk recorded the mean fork length and any marks observed on all fish randomly seen during the angler surveys.

Anglers were required to record chinook salmon larger than 60 cm (50 cm in 1956-77) on salmon-steelhead cards. We assumed that harvest estimates derived from the volitional return of cards were an unbiased estimate of the harvest of large spring chinook salmon in the Rogue River during 1956-94. This assumption is probably erroneous because the adjustment factor for a non-response bias is only applicable on a statewide basis (Hicks and Calvin 1964). However, we believe that estimates from salmon-steelhead cards provide a reasonable, but not necessarily precise, estimate of harvest because a large number of anglers fish the Rogue River.

We analyzed data from salmon-steelhead cards for spring chinook salmon harvested upstream or downstream of Gold Ray Dam. However, separate harvest estimates for each area were only available for 1984-94. Previously, we assumed that chinook salmon harvested before June were landed downstream of Gold Ray Dam and chinook salmon harvested in June and July were landed upstream of Gold Ray Dam (Cramer et al. 1985). Subsequent data from salmon-steelhead cards indicated that an average of 25% of the chinook salmon landed in May were harvested upstream of Gold Ray Dam. In addition, estimates of the migration timing (ODFW 1992) indicated that some fish harvested in the lower river should be classified as fall chinook salmon. Consequently, we assumed that 50% of the chinook salmon harvested downstream of Gold Ray Dam in July were fall chinook salmon rather than spring chinook salmon.

We used data from the distribution of harvest in 1984-94 to estimate the distribution of harvest in 1970-83 (Appendix Table B-21). We chose not to estimate harvest distribution prior to 1970 because angler participation in the upper river fishery increased during the 1960s relative to the fishery in the lower river (personal communication on 17 May, 1984, with Michael Jennings, ODFW, Grants Pass, Oregon).

### Harvest Composition

The composition of spring chinook salmon harvested in the area upstream of Gold Ray Dam could directly estimated only in 1980-81 when scales were collected and interpreted to classify the age and origin of fish harvested by anglers. However, angler surveys were designed to index catch rate and angler effort, rather than to estimate total harvest. Use of the angler survey data would underestimate harvest because some fish were harvested prior to start of the surveys and because clerks counted only bank anglers and boat trailers visible from survey routes. Thus, to estimate the composition of the angler harvest of spring chinook salmon upstream of Gold Ray Dam, we made the following assumptions:

- (1) we assumed that harvest estimates from salmon-steelhead cards accurately reflected the number of adults harvested upstream of Gold Ray Dam,
- (2) we assumed that 95% of the spring chinook salmon harvested by bank anglers were landed upstream of Shady Cove,
- (3) we assumed that the composition of spring chinook salmon harvested by bank anglers who fished downstream of Shady Cove was similar to the composition of fish harvested by boat anglers who fished downstream of Shady Cove,
- (4) we assumed that the distribution of boats used to fish for spring chinook salmon were the same in 1980-81 as in 1986-87.

We used these assumptions to calculate incomplete estimates of harvest within each of the two survey areas and then expanded the incomplete estimates of harvest to estimates of total harvest as indicated from salmon-steelhead cards.

The number of hours ( $H_i$ ) that anglers fished during each month within each of the two survey areas were estimated by developing an effort curve from partial counts of boat trailers and bank anglers as:



$$H_i = 1/2 \sum_{h=1}^5 (T_h - T_{h-1})(A_h + A_{h+1})$$

where

$T_h$  = time of day (military hours) at the  $h^{\text{th}}$  count and

$A_h$  = Mean number of boat anglers or bank anglers multiplied by the number of days in a month.

Angling effort was assumed to be zero at 0500 hours and 2100 hours. The mean number of boat anglers was estimated monthly within each survey area as:

$$A_h = (B_h)(D_h)(N_h)$$

where

$B_h$  = mean number of boat trailers counted at time  $h$ ,

$D_h$  = the proportion of boats that fished within the survey area at time  $h$ , and

$N_h$  = mean number of anglers in boats.

The distribution of boats during the spring chinook fishery in the upper river were estimated from data collected in 1986-87. In 1986, boats were counted from fixed wing aircraft at 0900 hours, 1400 hours, and 1900 hours five times monthly in May-July on randomly selected days. Surveyors made 45 flights and counted 2,062 boats. In June 1987, we made 7 flights at 0900 hours and 6 flights at 1900 hours and counted a total of 925 boats. In both years, surveyors counted only driftboats and sleds. Estimates of the mean number of anglers in each boat were obtained from data collected during angler surveys in 1980.

We estimated the partial monthly harvest ( $M$ ) of spring chinook salmon within each survey area as:

$$M = (H_i)(R_h)$$

where

$R_h$  = Catch rate (fish per angler hour) of jack or adult spring chinook salmon.

Data from incomplete and completed angler trips during the entire month were pooled to estimate catch rates. We assumed that no spring chinook salmon were released by anglers.

Partial estimates of total harvest during 1980 and 1981 were estimated by adding monthly estimates of partial harvest from both of the survey areas. Because bank anglers that fished downstream of Shady Cove were not surveyed, we assumed that harvest in that portion of the fishery was 5% of the harvest by bank anglers that fished upstream of Shady Cove. We also assumed that the proportions of jacks in the bank angler catch downstream of Shady Cove was equal to that in the boat catch downstream of Shady Cove.

We estimated the composition of the angler harvest within each survey area from life history interpretations of scale samples of unmarked jacks and adults. We multiplied the proportion of fish within each life history classification to estimate the partial harvest of each age of wild and hatchery spring chinook salmon.

We developed expansion factors for estimates of partial harvest in 1980 and 1981 by comparing estimates of the partial harvest of adult spring chinook salmon with estimates of harvest from salmon-steelhead cards. Assuming that harvest estimates from salmon-steelhead cards were accurate, comparisons indicate that harvest estimates from the angler surveys were underestimated by 30% in 1980 and by 47% in 1981. We used the estimates of underestimation to expand estimates of partial harvest to estimates of complete harvest.

### Simulation Model

We used some findings to develop a stochastic simulation model of produced as juveniles in the Rogue River upstream of Gold Ray Dam. The model is described in Model Structure, page 201.

We evaluated model sensitivity to changes in values of input variables (Evans and Dempson 1986). First, we ran a simulation with arithmetic mean values for input parameters. Means were determined from empirical data gathered during the project. Second, we ran an array of simulations with mean values for all input parameters, although we progressively changed the mean value of one input parameter by  $\pm 0.2$  standard deviations. We indexed model sensitivity as

$$S = Y(x_h) / Y(\bar{x}) \quad (4)$$

where

$S$  = sensitivity of output to changes in values of input parameters,  
 $Y(x_h)$  = model output with a change of 0.2 standard deviations for one input parameter, and  
 $Y(\bar{x})$  = model output with mean (arithmetic) values for all input parameters.

We evaluated the model by estimating the precision associated with predicted output. Predictions of transformed data were back-transformed to arithmetic values between sequential steps within the model. To estimate output precision, we developed 95% confidence intervals from 500 simulations with one set of input parameters. We discarded the lowest 2.5% of the simulation outputs to designate the lower confidence boundary. We discarded the largest 2.5% of the simulation outputs to designate the upper confidence boundary.

A series of 18 regressions compose the model, including 13 multiple regressions. Predicted output from each regression was allowed to vary stochastically within a normal distribution described by the regression prediction and the estimated variance associated with that prediction:

$$Y_{ij} = Y_i + (o_i) * (r_{ij}) \quad (5)$$

where

$i$  = regression equation (1,...11),  
 $j$  = simulation run (1,...500),  
 $Y_{ij}$  = predicted output of regression  $i$  adjusted by random number  $j$ ,  
 $\hat{Y}_i$  = predicted output of regression  $i$  with a  $x_i$  input value,  
 $\sigma_i^2$  = variance of  $Y_i$  predicted from regression  $i$ , and  
 $r_{ij}$  = random number  $j$  from a standard normal distribution used in regression  $i$ .

We estimated the variance of the predicted response from regressions with a single independent variable as

$$\sigma_i^2 = \text{MSE}_i * ((1/n_i) + (x_i - \bar{x}_i)^2/SS_i) \quad (6)$$

where

$\text{MSE}_i$  = residual mean square for regression  $i$ ,  
 $n_i$  = sample size of data used to develop regression  $i$ ,  
 $x_i$  = value of independent variable for each of 500 simulations,  
 $\bar{x}_i$  = arithmetic mean of independent variable used to develop regression  $i$ , and  
 $SS_i$  = corrected sum of squares of independent variable  $x_i$  used to develop regression  $i$ .

We estimated the variance of the predicted response from the multiple regressions in the model with the procedures of Neter and Wasserman (1974).

### Analytical Procedures

Data we believed to exhibit a normal distribution were analyzed with parametric statistics. Data with distributions judged to be other than normal were assessed with nonparametric statistics.

Because many of the data sets contained less than 10 observations, the assessment of normality was frequently subjective. Uncertainty about the normality of the data led us to defer testing for homogeneity of variances. In general, we used  $P \leq 0.05$  as the criteria for statistical significance. If sample sizes were small, we used  $P \leq 0.10$  as a significance level. We followed analytical methods outlined by Snedecor and Cochran (1967) and Zar (1984).

Parametric methods most commonly used included analysis of variance, correlation analysis, and regression analysis. We used analysis of variance to test for differences between means of preimpoundment and postimpoundment variables. Where no difference was noted, we calculated the minimum detectable difference (Zar 1984) to estimate how much the postimpoundment mean would have had to change in order for the change to be detected. Proportional or percentage data were arcsine transformed prior to analysis of variance.

We used a two factor analysis of variance to test for differences between means of life history parameters for different age classes among multiple brood years. Where differences were noted, we used a Newman-Keuls multiple range test to evaluate differences between specific age classes.

We used scatter plots and correlation analyses to investigate relationships among variables. We assumed that data were independent observations with a bivariate normal distribution and common variance. Data were transformed when

scatter plots suggested non-linear relationships among variables. Percentage or proportional data were logit transformed prior to regression and correlation analyses.

To quantify relationships between dependent and independent variables, we used regression and multiple regression analyses. Independent variables were assumed to be measured without error. This may be a reasonable assumption for measurements of physical factors (such as flow and upwelling), but is certainly erroneous for some biological data. Associated errors were probably smallest for life history parameters reported as means (such as length at ocean entry, and scale measurements). Only arithmetic means were used as independent variables. Estimates or indexes of fish abundance almost certainly contained major sources of error, particularly where numerous estimation steps and assumptions were required to derive the data.

However, because fish abundance is of key importance to this evaluation, and other analytical procedures may be less robust, we used regression analysis to estimate the quantitative relationships between variables. Independent variables were included in regression analyses only when our previous findings (Cramer et al. 1985) or results from other research identified variables as probable causal factors associated with the dependent variable in question. Despite this step, there are probably multiple specification errors among regressions we present in this report.

Other potential problems associated with multiple regression analysis include autocorrelation, heteroscedasticity, and multicollinearity. We evaluated the potential for autocorrelation by the Durbin-Watson test. We evaluated the potential for heteroscedasticity by plotting residual values from a regression on the associated values of the dependent variable. We attempted to minimize the potential for multicollinearity by (1) use of correlation analysis to identify relationships between independent variables and (2) limiting the number of independent variables included in regressions.

We used regressions to predict values of a dependent variable from values of independent variable(s). Ricker (1973) and Jensen (1986) recommend use of predictive regression rather than functional regression if the objective is prediction rather than description of functional relationships. We chose predictive regression because our primary objective was to predict the response of dependent variables to variations in independent variables.

## RESULTS AND DISCUSSION

### Physical Factors

USACE personnel used the QUAL II model (Hamlin and Nestler 1987) to simulate flow, water temperature, and turbidity for regulated (with dams) and unregulated (without dams) conditions in 1978-86. In this section of the report, we summarize some of the findings that are directly relevant to the production and harvest of spring chinook salmon in the Rogue River. Changes in water temperature are more thoroughly discussed because of changes in release strategies that began in the spring of 1986.

## Flow

Operation of Lost Creek Dam affected flow in downstream areas. Storage of inflow occurred primarily from January through April and peaked in February (Figure 9). The reservoir reached full pool each year, usually by 1 June, but did not fill in 1992 or 1994. In 1978-86, augmentation of natural flow usually began in the middle of June, peaked in July and August, and continued through the end of November (Figure 9). In 1987-94, flow augmentation peaked in late August and rarely continued into October (USACE unpublished data).

The relative effect of reservoir operation decreased with distance downstream. Regulated flow generally ranged between 3,000 and 5,000 cfs at Raygold from January through April in 1978-86 (Figure 10). Downstream at Agness, regulated flow usually ranged between 7,000 and 10,000 cfs during the same period (Figure 10). As tributary flow declined in late spring and early summer, flow in the lower river became similar to flow in the upper river.

Operation of Lost Creek Dam decreased the intensity of peak flows in the Rogue River. The USACE estimated that reservoir operation decreased peak flow at Grants Pass by an average of 6,300 cfs annually (range = 200-10,900 cfs) in 1977-78 through 1985-86 (Appendix Table C-1).

## Water Temperature

Water temperature increased in November-January and decreased in June-September throughout the river in 1978-86. Effects of reservoir operation on water temperature diminished with distance downstream from Lost Creek Dam.

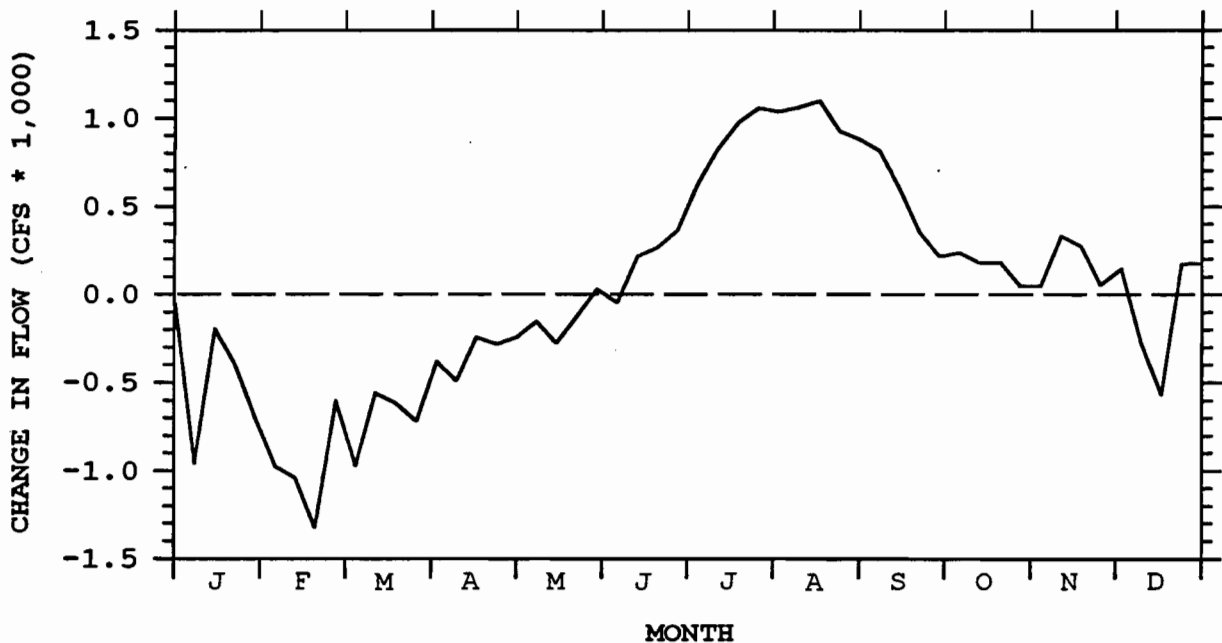

Figure 9. Change in mean weekly flow caused by the operation of Lost Creek Dam, 1978-86. The zero-line represents unregulated flow (inflow = outflow).

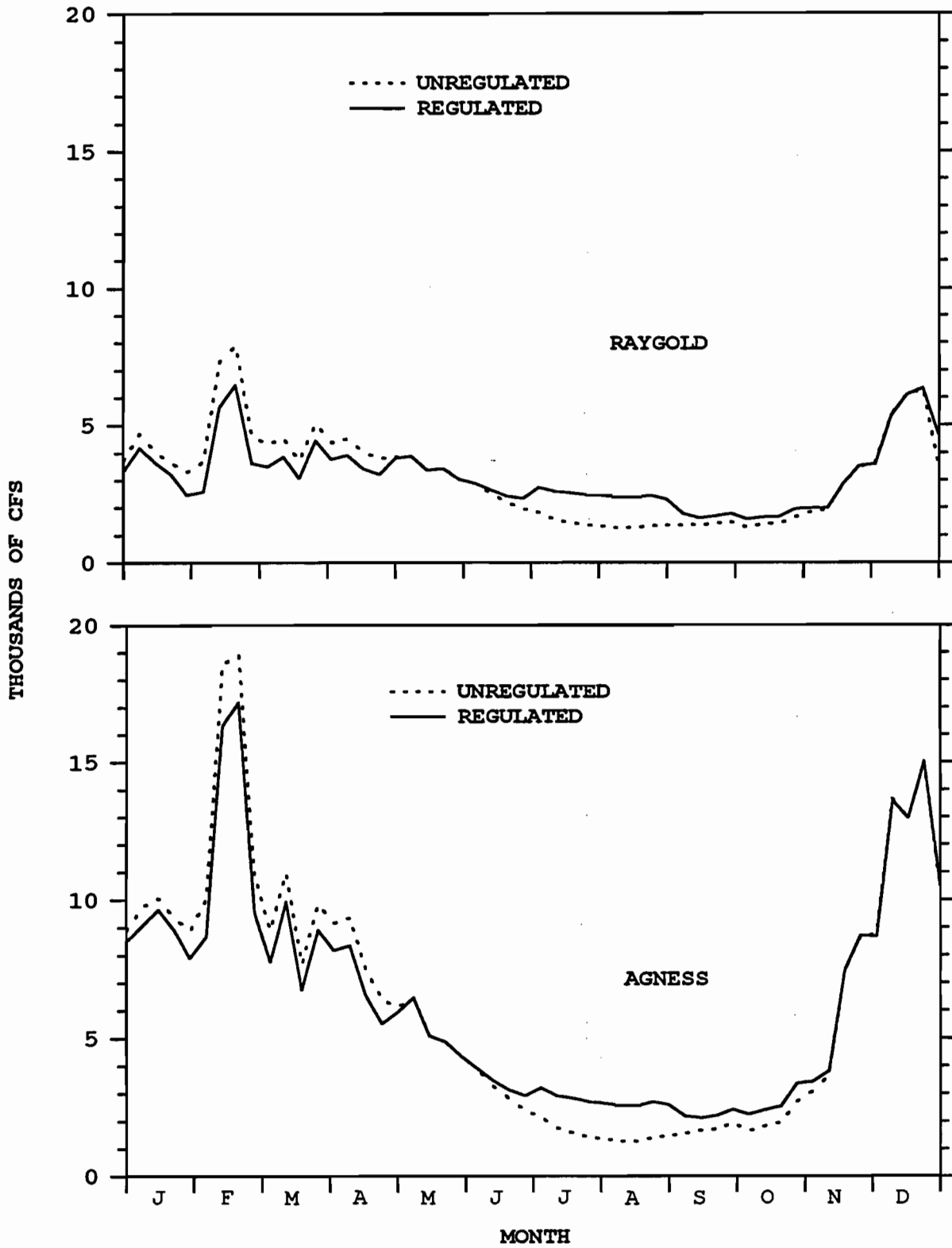

Figure 10. Mean weekly flow in the upper river at Raygold, and in the lower river at Agness, simulated for regulated and unregulated conditions during 1978-86.

USACE simulations indicated that reservoir operation increased average water temperature in November-January by 1.5°C at Raygold and by 1.0°C at Marial. At the thermal peak in summer, operation of the dam reduced average water temperature at Raygold and Marial by 3.5°C and 3.2°C, respectively.

Release strategies for water temperature were modified in 1985-89 as compared to previous years. As a result, water temperature in the upper river increased during late summer, but decreased during late spring, early summer, and early autumn (Figure 11).

Release of reservoir storage from lower ports on the water intake tower decreased water temperature in the upper river during the period that eggs incubated in the gravel. From the middle of September through the middle of October, mean weekly water temperatures decreased significantly after the modification in operating strategy (Table 14). For the 5-week period of 17 September through 21 October, water temperature averaged 9.7°C during 1978-84 and 7.7°C during 1986-91. The decrease of 2.0°C in average temperature during this period was significant at  $P < 0.001$ .

Table 14. Comparison of mean maximum water temperature near McLeod before and after the change in operating strategy at Lost Creek Dam during autumn of 1985. Time interval approximates the period that eggs and alevins of spring chinook salmon incubated in the gravel.

Dates	Water temperature (°C)		P for difference
	1977/78 to 1984/85	1985/86 to 1989/90	
09/10-09/16	11.1	11.2	0.910
09/17-09/23	11.0	8.5	<0.001
09/24-09/30	10.7	7.9	<0.001
10/01-10/07	9.8	7.7	<0.001
10/08-10/14	9.0	7.4	0.003
10/15-10/21	8.4	7.2	0.024
10/22-10/28	7.7	7.3	0.330
10/29-11/04	7.7	7.4	0.328
11/05-11/11	8.0	7.4	0.239
11/12-11/18	7.7	7.4	0.522
11/19-11/25	7.4	7.1	0.592
11/26-12/02	7.0	6.8	0.633
12/03-12/09	6.9	6.7	0.725
12/10-12/16	6.4	6.1	0.511
12/17-12/23	6.1	5.6	0.163
12/24-12/31	5.8	5.4	0.151
01/01-01/07	5.6	5.3	0.351
01/08-01/14	5.5	5.2	0.339
01/15-01/21	5.2	5.0	0.446
01/22-01/28	5.2	5.0	0.521

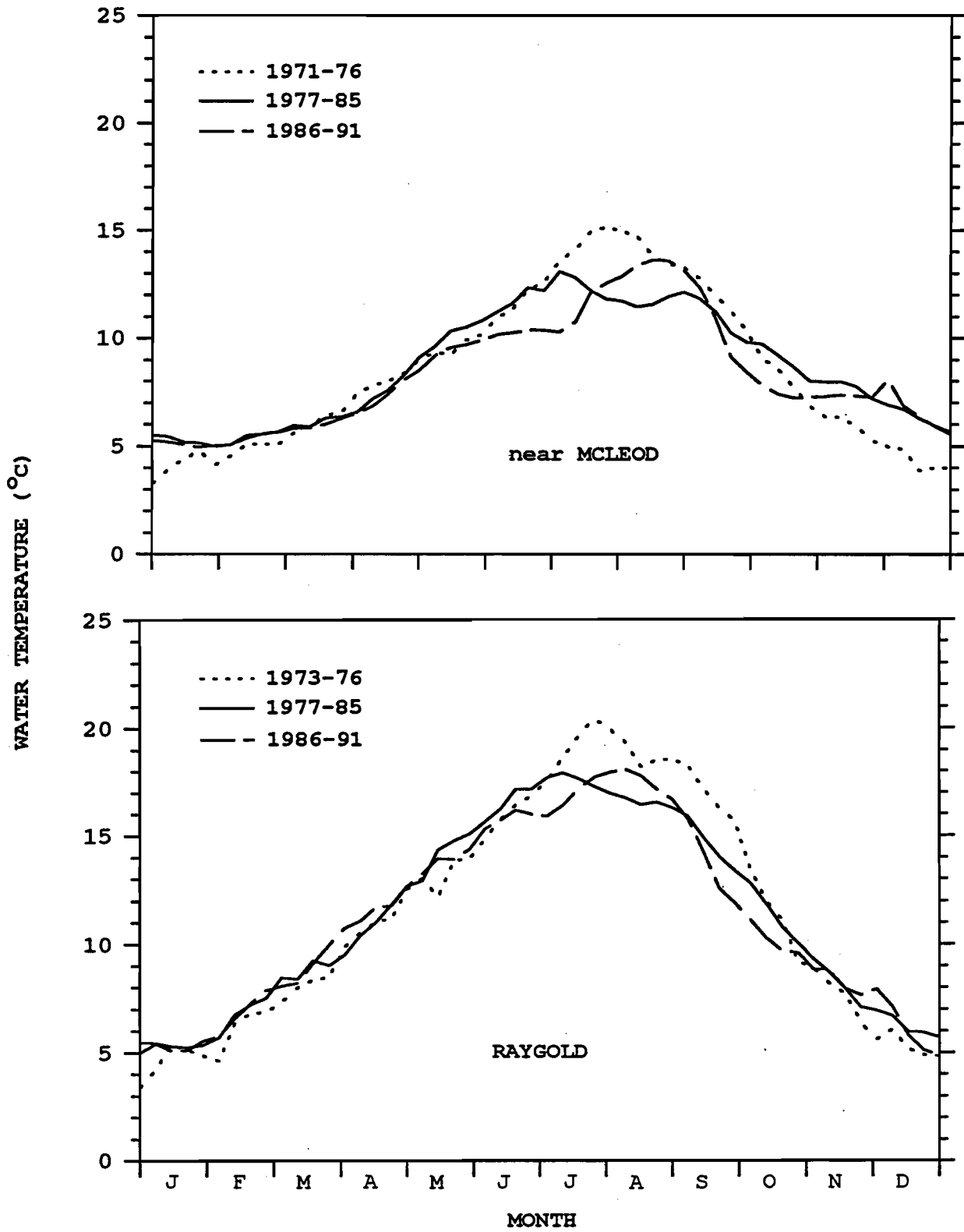

Figure 11. Mean weekly maximum water temperature in the upper river under two strategies of reservoir releases as compared to the period before reservoir operation.



Release of colder water from the reservoir during the early autumn did not appear to increase river temperature during the later part of autumn, or during early winter. From the later portion of October through the later portion of January, mean weekly water temperatures in the upper river during 1985-86 through 1989-90 did not differ significantly from that during 1977-78 through 1984-85 (Table 14).

Change in operation strategy also decreased water temperature during the time period that juvenile spring chinook salmon reared in the upper river. From early June through the middle of July, mean weekly water temperatures were significantly lower during 1986-90 compared with 1978-85 (Table 15). For the 6-week period of 4 June through 15 July, water temperature averaged 12.4°C during 1978-85 and 10.5°C during 1986-89. The decrease of 1.9°C in average temperature during this period was significant at  $P < 0.001$ .

Conversely, water temperature in the upper river during August increased as compared with previous postimpoundment years. Weekly water temperatures in August were 1.3°C to 2.0°C greater in 1986-90 compared with 1978-85 (Table 15). For the 4-week period of 30 July through 26 August, water temperature averaged 11.7°C during 1978-85 and 13.4°C during 1986-89. The increase of 1.7°C in average temperature during this period was significant at  $P < 0.001$ .

Table 15. Comparison of mean maximum water temperature near McLeod before and after the change in operating strategy at Lost Creek Dam that began in autumn of 1985. Time interval approximates the period that juveniles reared in the upper river.

Dates	Water temperature (°C)		P for difference
	1978-85	1986-90	
05/07-05/13	9.7	9.3	0.606
05/14-04/20	10.3	9.7	0.227
05/21-04/27	10.4	9.8	0.191
05/28-06/03	10.9	9.9	0.179
06/04-06/10	11.2	10.2	0.142
06/11-06/17	11.6	10.3	0.022
06/18-06/24	12.4	10.4	0.012
06/25-07/01	12.1	10.4	0.008
07/02-07/08	12.9	10.4	0.001
07/09-07/15	12.7	10.9	0.004
07/16-07/22	12.2	12.1	0.801
07/23-07/29	11.8	12.6	0.148
07/30-08/05	11.7	13.0	0.003
08/06-08/12	11.5	13.5	<0.001
08/13-08/19	11.6	13.8	0.002
08/20-08/26	11.9	13.3	0.074
08/27-09/02	11.8	13.0	0.163

**Model for the Marial Gage:** We developed an analysis to predict water temperature at Marial in May and June because the gage was not operational after 1987 and the predictions were needed to optimize allocation of reservoir storage in the drought year of 1994. A multiple regression indicated that daily maximum water temperature at Marial in May-June of 1977-87 was significantly related to maximum air temperature at Medford, flow at Agness, and day-of-year (Appendix Table C-2). These independent variables accounted for 72% of the variation in the dependent variable. Regression coefficients indicated that water temperature in the canyon in late spring and early summer increased as (1) air temperatures increased, (2) flow decreased, and (3) day-of-year increased. We were unable to evaluate the performance of the model because no water temperature gage operated in the canyon during 1994, the only year the model was used by reservoir managers.

The regression coefficient associated with the flow variable suggested that daily maximum water temperature at Marial in May-June would decrease by  $1.1^{\circ}\text{C}$  (95% CI =  $+0.2^{\circ}\text{C}$ ) for a 1,000 cfs increase in river flow. USACE simulations with the WESTEX and QUALII models (Hamlin-Tillman and Haake 1990) for reservoir releases planned in 1994 and meteorological conditions observed in 1977 indicated that water temperature at Marial in May-June would decrease by  $0.8^{\circ}\text{C}$  (95% CI =  $+0.1^{\circ}\text{C}$ ) for a 1,000 cfs increase in reservoir outflow (simulation estimates were received from Russell Davidson, USACE, Portland District, Portland on 24 May, 1994).

USACE simulations also indicated that the effects of increased outflow from the reservoir changed through time. A 1,000 cfs simulated increase in reservoir outflow predicted a  $0.9^{\circ}\text{C}$  (95% CI =  $+0.2^{\circ}\text{C}$ ) decrease in water temperature at Marial for 1-15 May and predicted a  $0.4^{\circ}\text{C}$  (95% CI =  $+0.2^{\circ}\text{C}$ ) decrease in water temperature at Marial for 16-30 June. We also found that the temporal effects of flow augmentation differed in the period of May-June.

A plot of residual variation on observed water temperature indicated that values predicted by the regression differed from observed values by as much as  $3^{\circ}\text{C}$  (Figure 12). Also, residual variation increased significantly ( $P < 0.001$ ) as water temperature increased (Figure 12). Predicted values averaged  $1.2^{\circ}\text{C}$  less than observed values when water temperatures ranged between  $16^{\circ}\text{C}$  and  $17^{\circ}\text{C}$  and averaged  $1.1^{\circ}\text{C}$  more than observed values when water temperatures ranged between  $23^{\circ}\text{C}$  and  $24^{\circ}\text{C}$ . These findings indicated that model predictions were too high at low water temperatures and were too low at high water temperatures.

The systematic error is large enough to be of concern to reservoir managers. Use of the ODFW regression would result in reservoir releases in May and June that are greater than needed during periods of low water temperatures and are less than needed during periods of high water temperatures. Optimal use of reservoir storage is critical during these months during years of low flow because prespawning mortality rates can exceed 70% among spring chinook salmon (see Prespawning Mortality, page 162).

We recommend that the USACE develop a more appropriate model that reservoir managers can use to schedule releases on a daily basis in order to minimize mortality among spring chinook salmon. In the interim, use of the ODFW model will make more efficient use of reservoir storage during years of low water yield because other water temperature models produced similar results, but were difficult for reservoir managers to use on a daily basis.

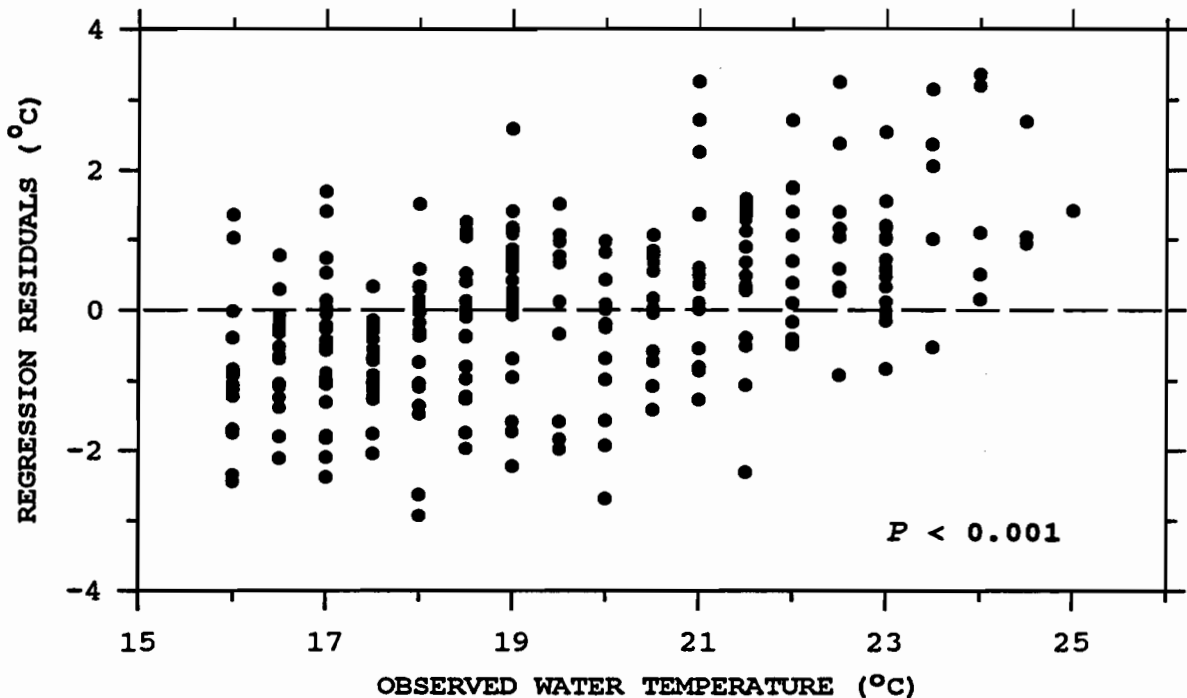

Figure 12. Residuals from the regression of the daily maximum water temperature in May-June at Marial plotted on observed values.

### Turbidity

River turbidity varied greatly on a seasonal basis. We measured turbidity as high as 140 Jackson Turbidity Units (JTU) and as low as 1 JTU during angler surveys. Throughout the river, turbidity in summer usually ranged between 2 and 4 JTU in 1978-86 (Figure 13). In winter, turbidity increased with distance downstream from Lost Creek Dam, most noticeably during periods of high flow. Simulation models developed by USACE indicated that mean weekly turbidity never exceeded 20 JTU in the upper river, but exceeded 50 JTU in the canyon (Figure 13). Tributary streams increased turbidity in the mainstem when flows increased after periods of high precipitation.

USACE simulations indicated that reservoir operation usually reduced turbidity of the Rogue River in 1978-86. At Dodge Bridge, regulation reduced average turbidity by 6 JTU in April-June and by 3 JTU in November-March (Figure 13). Downstream at Marial, regulation reduced average turbidity by 4 JTU in November-March and 1 JTU in April-June (Figure 13). In the canyon and in the upper river, operation of the dam reduced average turbidity by less than 1 JTU in July-October. Based on a review completed by Lloyd (1987), we concluded that changes in turbidity likely had minimal effects on the production and life history of anadromous salmonids in the Rogue River.

### Gravel Size and Abundance

We estimated the mean size of gravel in 1978 and 1981 at three locations just downstream of Lost Creek Dam and in Big Butte Creek near the mouth.

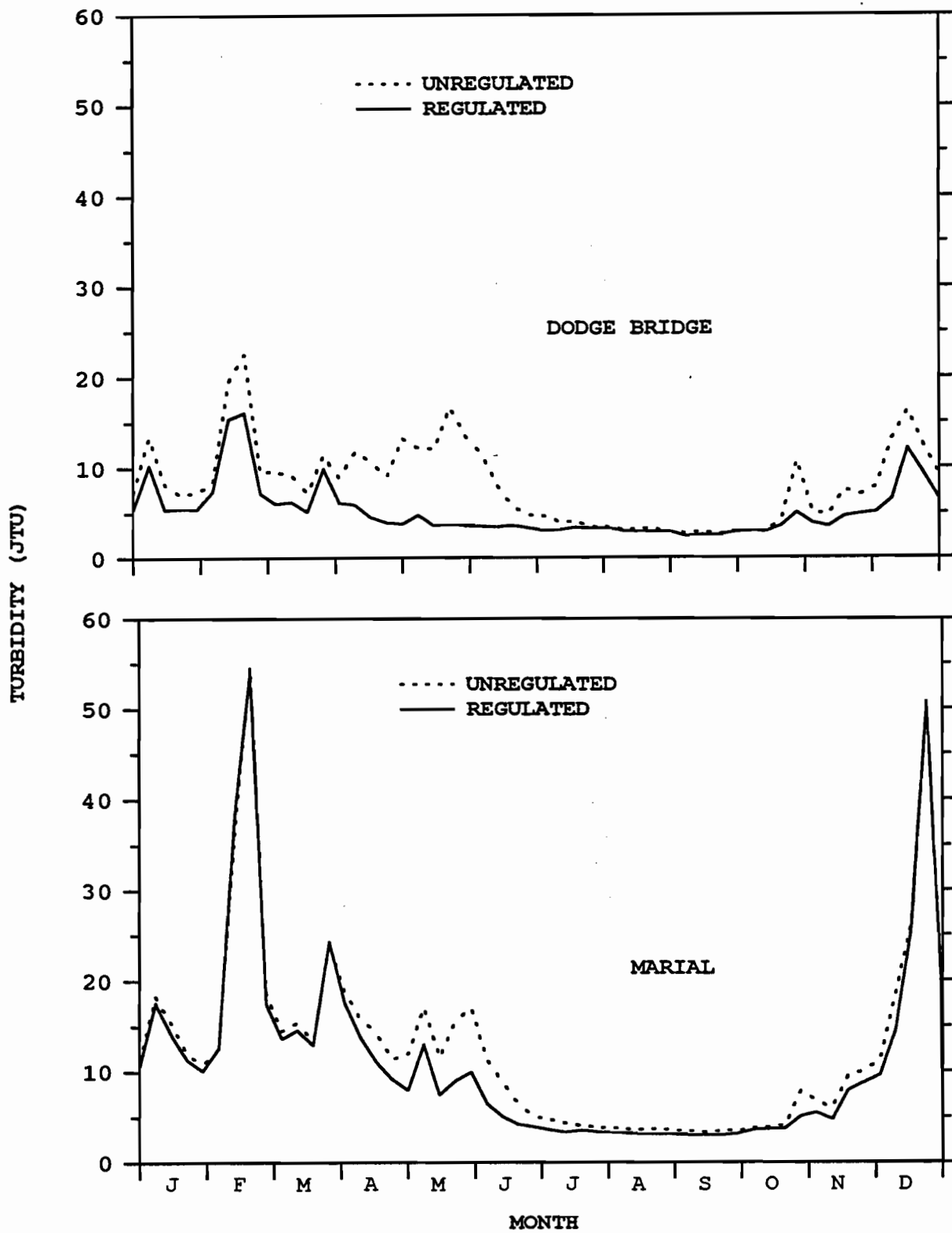

Figure 13. Mean weekly turbidity (Jackson Turbidity Units) in the upper river at Dodge Bridge, and in the Rogue River canyon at Marial, simulated for regulated and unregulated conditions during 1978-86.

Results suggested that the percentage of fines (material <1.0 mm in diameter) changed between 1978 and 1981 except in the side channel at Sand Hole (Appendix Table C-3). However, comparisons between sites and between years are questionable because we sampled only one transect at each location.

Substrate composition is an important factor that affects egg to fry survival rates among salmonids (Chapman 1988). In addition, the number of potential spawning sites is related to the amount of gravel present in streams. While gravel recruitment will continue from the banks of the Rogue River and from tributary streams, the number of spawning sites for spring chinook salmon may decrease because gravel is no longer recruited from areas upstream of Lost Creek Dam.

We recommend that the USACE survey gravel resources in the Rogue River between Lost Creek Dam and Dodge Bridge and should repeat surveys every ten years to monitor the amount of gravel present in the channel. If gravel resources decrease significantly through time, the USACE should add gravel to the river to compensate for gravel losses that result from reservoir construction. Construction of artificial spawning areas, to mitigate for gravel losses, is not recommended unless spawning success is to be evaluated and the sites are monitored annually (Kondolf et al. 1996).

## Juveniles

### Emergence Timing

Dates of first capture of newly emergent fry of chinook salmon at seining sites upstream of Gold Ray Dam in 1975-81 ranged between early January and the middle of March (Appendix Table D-1). Estimated dates of emergence completion in 1975-94 ranged between late March and late May (Appendix Table D-1). Fry emergence timing in other populations of chinook salmon in Oregon also tends to be in late spring (Reimers 1973; Lindsay et al. 1986; Jonasson and Lindsay 1988; Nicholas and Hankin 1988).

Chinook salmon fry emerged earlier in the upper river after the initial operation of Lost Creek Dam. We found that the mean date of first capture was 52 days earlier at Sand Hole in 1975-77 as compared to 1978-81 (Table 16). There was also an indication that first emergence occurred earlier farther downstream at High Banks, but there was no indication that the time of first emergence changed in Big Butte Creek (Table 16).

Time of emergence completion also changed significantly after operation of Lost Creek Dam (Table 16). Mean date of emergence completion at Sand Hole was 19 days earlier in 1978-84 as compared to 1975-77. At High Banks, fry completed emergence an average of 23 days earlier in 1978-84 as compared to 1975-77. Fry also completed emerged an average of 29 days earlier in Big Butte Creek because water temperatures in this tributary were greater in March and April of 1978-81 as compared to 1975-77 (Cramer et al. 1985).

Water temperature is a major determinate of development rate of eggs and alevins of chinook salmon (Alderdice and Velsen 1978; Heming 1982; Beacham and Murray 1990). Eggs and alevins develop faster in warmer water as compared to cooler water. Yolk reserves are depleted faster, and fry emerge from the

Table 16. Comparisons of mean indexes of emergence timing for chinook salmon fry seined in the Rogue River upstream of Gold Ray Dam, 1975-94. The date when mean lengths continually exceeded 4.5 cm was assumed to represent date of emergence completion. Within rows, means with different superscripts differed at  $P < 0.05$  based on a Newman-Keuls Multiple Range Test.

Sampling site	Preimpoundment	Postimpoundment		P for difference
	1975-77	1978-84	1985-94	
<b>DATE OF FIRST CAPTURE</b>				
Sand Hole	8 March	16 January	--	0.003
High Banks	3 March	5 February	--	0.078
Big Butte Creek	10 February	15 February	--	0.751
<b>EMERGENCE COMPLETION</b>				
Sand Hole	27 May <sup>a</sup>	8 May <sup>b</sup>	13 May <sup>b</sup>	0.015
High Banks	3 May <sup>a</sup>	10 April <sup>b</sup>	16 April <sup>b</sup>	0.013
Big Butte Creek	21 May	19 April	--	0.005

gravel earlier, when incubated at greater temperatures. Consequently, the tendency salmonid fry to emerge earlier in downstream areas of streams, even though spawners lay eggs earlier in upstream areas, is not unique to chinook salmon in the Rogue River (Webb and McLay 1996).

Simulations of water temperature by the USACE indicated that reservoir operation increased the water temperature of the Rogue River while eggs and alevins of chinook salmon incubated in the gravel during 1978-86 (USACE 1991). Their findings suggested that reservoir operation in October-December increased the mean daily water temperature by an average of 2.6°C at the USGS gage near McLeod and by an average of 1.0°C at the USGS gage at Raygold.

Based on the changes in water temperature estimated from the USACE simulations, we estimated that reservoir operation caused fry to emerge in 1978-86 an average of 28 days earlier at the USGS gage near McLeod and an average of 17 days earlier at the Raygold USGS gage. To derive these estimates, we assumed a mean spawning date of 1 October (see Spawning Time, page 173) and 1,835 temperature units to the "button up" stage of fry development (personal communication dated 20 September 1991 from Michael Evenson, ODFW, Cole M. Rivers Hatchery, Trail, Oregon).

USACE simulations of water temperature in the Rogue River indicated that 1,835 temperature units accumulated at the USGS gage near McLeod by 19 April for unregulated conditions and 22 March for regulated conditions, and at the Raygold gage by 23 March for unregulated conditions and 6 March for unregulated conditions. Similar assessments could not be completed for years after 1986 because the USACE did not simulate river temperatures for those years.

In 1984-93, ODFW recommended to the USACE that reservoir releases from the middle of September through the middle of November be managed so that

outflow temperatures were 3°C less than water temperatures were in 1972-76. ODFW formulated this recommendation in an attempt to restore the natural emergence time of spring chinook salmon fry in the upper river. However, subsequent sampling suggested that fry continued to emerge early despite the recommended change in release strategy.

We found that the mean time of emergence completion did not differ significantly in 1985-94 as compared to 1978-84 at either Sand Hole or High Banks (Table 16) even though there were good chances that changes could have been detected. A sensitivity analysis indicated that to have an 80% chance of detecting a change at the 95% confidence level, fry at Sand Hole would have had to emerge an average of 7 days earlier or later in 1985-94 as compared to 1978-84. A similar analysis of the data from High Banks indicated that the mean date of emergence completion would had to change by 8 days for the change to be detected by field sampling.

Later spawning by adult chinook salmon that originated from broods produced after operation of Lost Creek Dam (see Spawning Time, page 173) partially accounted for the continued late timing of fry emergence in 1985-94. To better evaluate the effects of changes in water temperature at time of release from Lost Creek Dam, we estimated the mean time of emergence for fry produced by females that spawned on 15 September, 1 October, and 15 October, and assumed that fry emerged after the accumulation of 1,835 temperature units. Dates chosen represented early, median, and late spawning times by spring chinook salmon in the Rogue River (see Spawning Time, page 173).

We estimated that, regardless of parental spawning dates, fry emerged significantly earlier in postimpoundment years as compared to preimpoundment years (Table 17). Our estimates suggested that fry produced from parents that spawned on 15 September emerged an average of 45 days earlier in 1978-84 as compared to 1972-77, and an average of 32 days earlier in 1985-94 as compared to 1972-77.

Effects were less pronounced on fry produced from late spawning adults. Fry produced from adult fish that spawned on 15 October emerged an average of 29 days earlier in 1978-84 as compared to 1972-77 and an average of 28 days earlier in 1985-94 as compared to 1972-77 (Table 17). These estimates show

Table 17. Comparisons of mean date of emergence estimated for fry produced by female chinook salmon that spawned on three dates near McLeod, 1972-94. Differences were assessed with analysis of variance. Within rows, means with different superscripts differed at  $P \leq 0.05$  based on a Newman-Keuls Multiple Range Test.

Date of spawning	1972-77	1978-84	1985-94	P for difference
15 September	20 March <sup>a</sup>	4 February <sup>b</sup>	17 February <sup>b</sup>	<0.001
1 October	14 April <sup>a</sup>	8 March <sup>b</sup>	15 March <sup>b</sup>	<0.001
15 October	29 April <sup>a</sup>	31 March <sup>b</sup>	1 April <sup>b</sup>	<0.001

that changes in water temperature affected the emergence timing of progeny of early spawning parents to a greater degree as compared to the progeny of late spawning parents. If emergence time is a critical life history parameter of salmonids (Bams 1969; Ricker 1972; Godin 1981; Miller and Brannon 1981), then a change in emergence time should elicit some change in another life history parameter as the population adapts to new environmental conditions.

We also found that reductions in reservoir outflow temperature in late summer and autumn of 1984-93 delayed fry emergence to some degree and that the delay was most noticeable among fry produced by adults that spawned first. Estimates of mean emergence time of fry produced by adults that spawned on 15 September was 13 days later in 1985-94 as compared to 1978-84. In contrast, the estimated difference in mean emergence time for fry produced by adults that spawned on 15 October was only one day in 1985-94 as compared to 1978-84. While means did not significantly differ at  $P < 0.05$  (Table 17), the relationship between water temperature and developmental rates of eggs and alevins of chinook salmon has been well documented (Alderdice and Velsen 1978; Heming 1982; Murray and Beacham 1987).

Consequently, although the effects of reservoir operation on water temperature of the Rogue River were not simulated for the period of 1987-94, we concluded that reservoir operation in 1985-94 continued to cause fry of spring chinook salmon to emerge earlier as compared to natural conditions. While it is possible to conserve additional hypolimnetic storage to further decrease water temperature in autumn, there are other beneficial fishery uses for that limited amount of cold water (see Evaluation of Reservoir Release Strategies, page 211).

## Abundance

Annual catch rates of juvenile chinook salmon at Sand Hole and High Banks averaged 657 fry per seine haul in 1976-94. Mean catch rates varied significantly ( $P < 0.001$ ) between years and ranged between 47 and 1,704 fry per seine haul (Appendix Table D-3). Seine catches suggested that newly emergent fry were most abundant in the late 1980s and were least abundant in the late 1970s and early 1980s (Figure 14).

We assumed that catch rates reflected the abundance of wild chinook salmon fry in the upper river and hypothesized that four primary factors influenced fry production: (1) numbers of female parents, (2) flow when parents spawned, (3) intensity of peak flow when eggs and alevins incubated in the gravel, and (4) water temperature when eggs and alevins incubated in the gravel. Data used to evaluate this hypothesis are in Appendix Table D-3.

We found that the abundance of female spawners, intensity of peak flows during incubation of embryos, and water temperature during incubation of embryos were related to annual catch rates of fry seined at Sand Hole and High Banks. A multiple regression analysis indicated that fry catch rates were positively related to spawning escapement, and were negatively related to water temperature and to the intensity of peak flow (Appendix Table D-4).

Of the three independent variables, peak flow was most highly correlated with fry catch rates (Appendix Table D-4). Residual variation from that



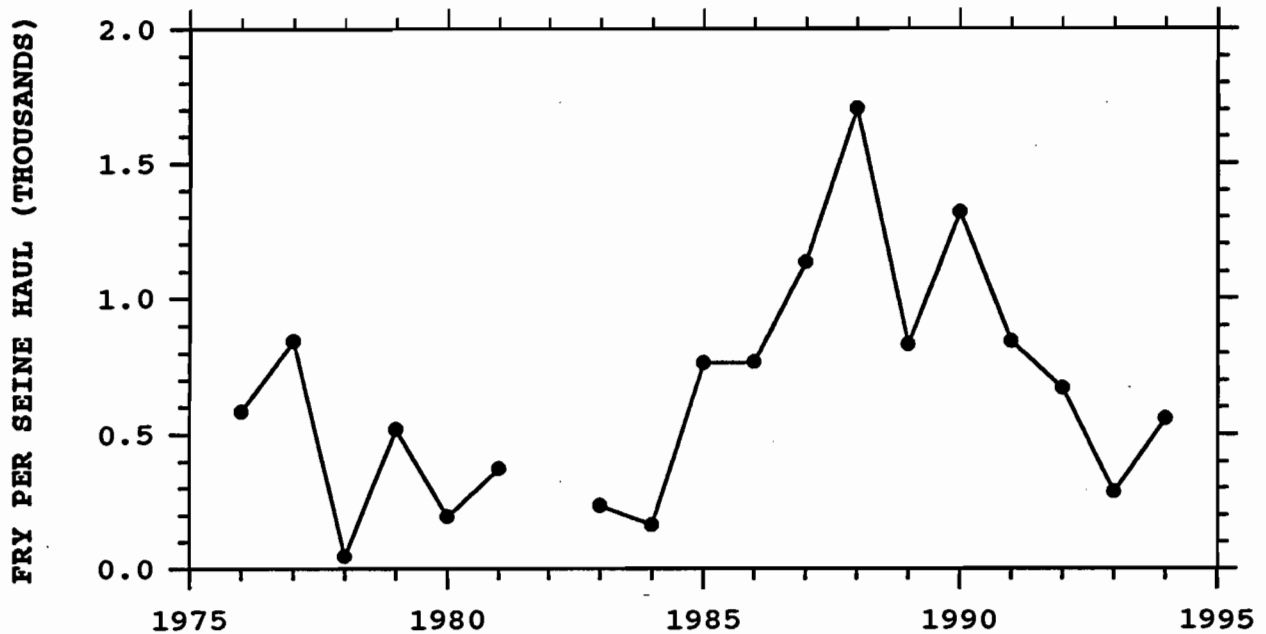

Figure 14. Mean annual catch rates of chinook salmon fry seined at Sand Hole and High Banks, 1976-94.

relationship (Figure 15) was significantly related to annual counts of spawned female carcasses in standard areas surveyed in the previous year (Figure 15). Finally, residual variation from that relationship was significantly related to water temperature during the period eggs and alevins incubated in the gravel (Figure 15). The relationship between the observed catch rates of fry and catch rates predicted by the regression is also presented in Figure 15.

Results of the multiple regression must be interpreted with caution. Inclusion of three independent variables is probably excessive for a regression analysis with 18 years of data. However, we have some confidence in the results because (1) the effects of each independent variable on salmonid production is documented in the literature, (2) independent variables in the regression were not intercorrelated (Appendix Table D-5), and (3) analysis of the number of wild juveniles that migrated past Savage Rapids Dam produced comparable results.

In addition, carcass counts of spawned females, although an independent variable, were not measured without error. Recovery efficiency of salmon carcasses varies in relation to flow (Fustish et al. 1994) and body size (Solazzi 1984). We included carcass counts as an independent variable because we found that carcass counts were highly correlated with estimates of spawning escapement (see Abundance at Spawning, page 100) and because river flow does not vary greatly during the period when spring chinook salmon spawn in the Rogue River.

Our analysis assumed that variations in seine catches at Sand Hole and High Banks reflected variations in the abundance of juvenile chinook salmon produced in the Rogue River upstream of Gold Ray Dam. This assumption seemed reasonable as catch rates at the seining sites were highly correlated ( $r = 0.92$ ,  $P < 0.001$ ) with numbers of wild juvenile chinook salmon estimated to have passed Savage Rapids Dam (Figure 16).

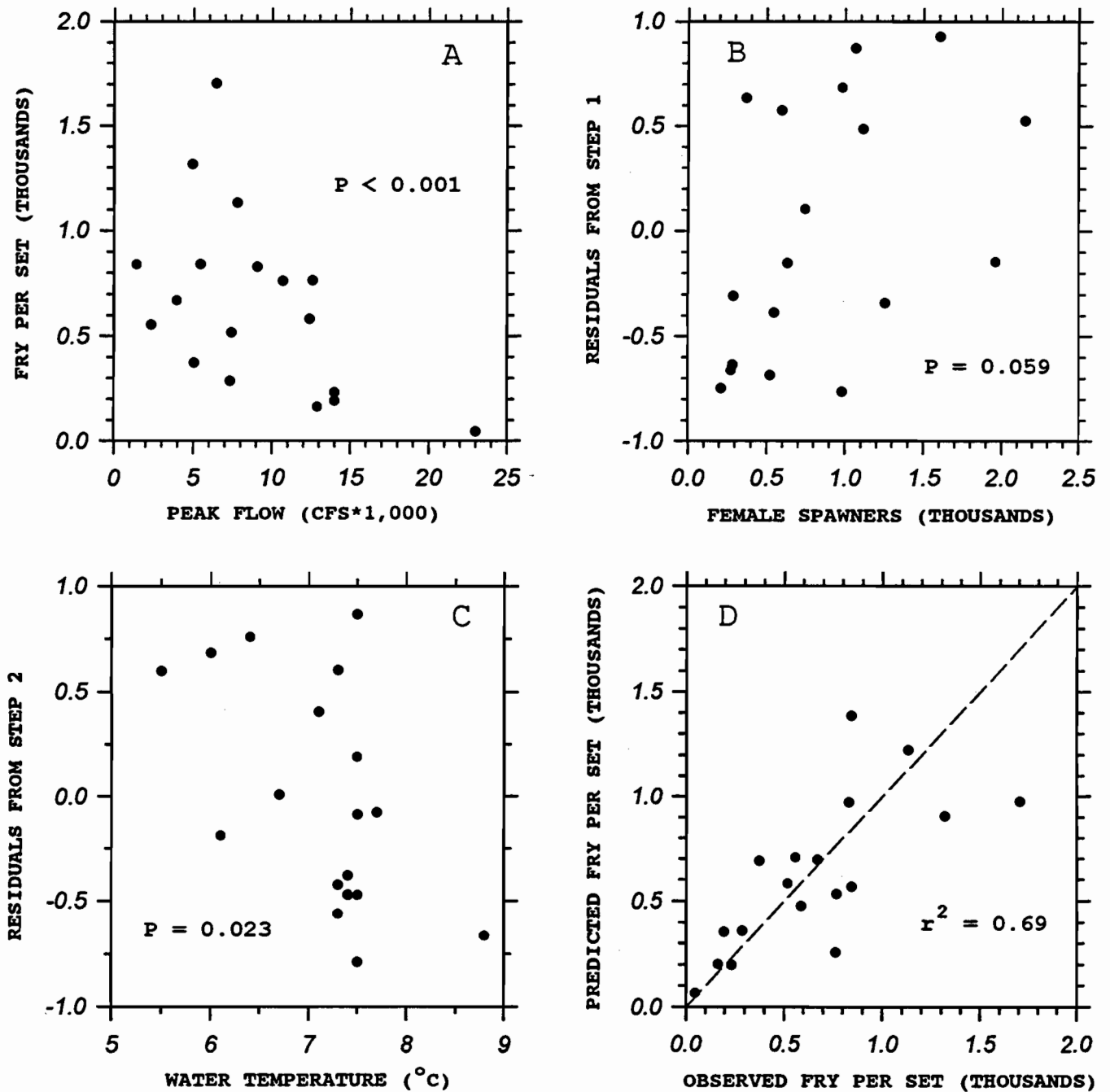

Figure 15. Steps in the analysis of factors related to the abundance of chinook salmon fry, 1975-93 brood years. Variables within plots are (A) mean annual catch rates of fry at Sand Hole and High Banks, and the peak mean daily flow at Dodge Bridge in the preceding November-February, (B) residual variation from relationship (A) and the number of spawned female parents counted between Cole M. Rivers Hatchery and Rogue Elk Park, and (C) residual variation from relationship (B) and mean maximum water temperature near McLeod in the preceding October-December. Plot D compares values predicted from the regression with observed values.

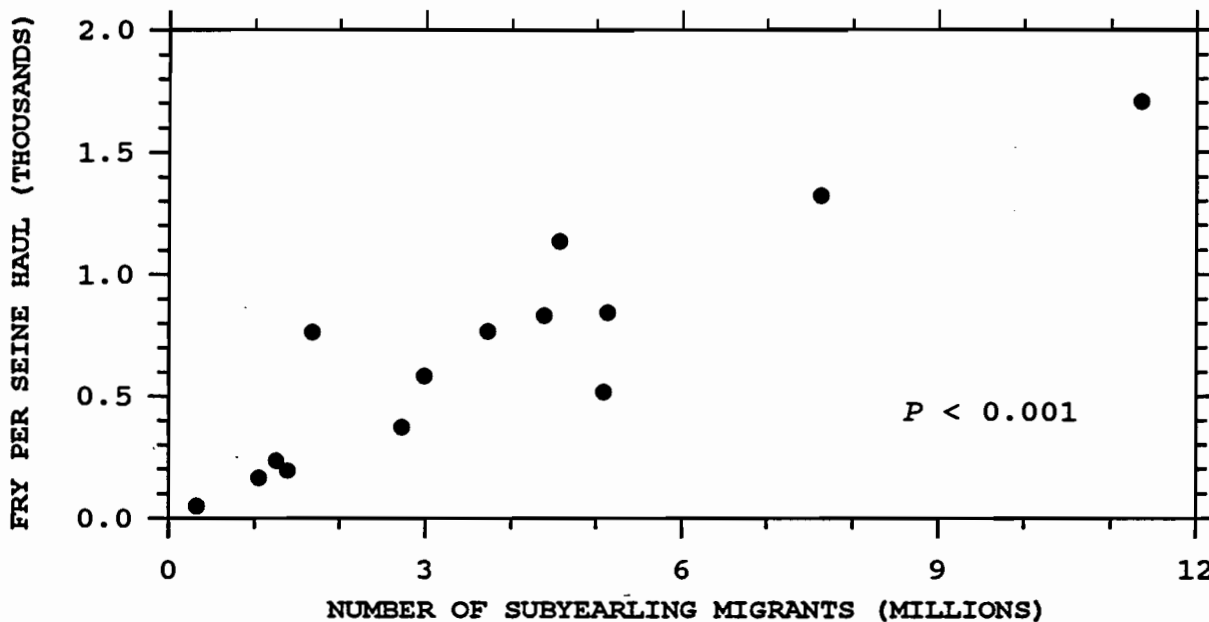

Figure 16. Relationship between the mean annual catch rates of wild chinook salmon fry at Sand Hole and High Banks and the estimated number of subyearling cohorts that migrated past Savage Rapids Dam, 1976-90.

We estimated that an average of 3.5 million wild subyearling chinook salmon passed Savage Rapids Dam annually between 14 May and 30 September in 1975-90. Annual estimates ranged between 0.3 and 11.4 million fish (Appendix Table D-6). Numbers of migrants were lowest in the early 1980s and greatest in the late 1980s (Figure 17). However, estimates of migration timing indicated that some fish passed Savage Rapids Dam before 14 May and some fish passed after 30 September (see Passage Timing at Savage Rapids Dam:, page 88).

Although major assumptions had to be made related to trap efficiency (see Abundance, page 27), we believe the estimates of the numbers of migrants are reasonable because (1) numbers of migrants were highly correlated with annual catch rates of chinook salmon fry at the seining sites and (2) the number of juvenile fish released in June from Cole M. Rivers Hatchery was comparable in three of four years to the number of those fish estimated to have passed Savage Rapids Dam (Table 18 and Appendix Table D-7).

As in the analysis of seine catches of fry, we hypothesized that four primary factors influenced the number of wild juveniles that migrated past Savage Rapids Dam: (1) number of female spawners, (2) flow when adults spawned, (3) intensity of peak flow when eggs and alevins incubated in the gravel, and (4) water temperature when eggs and alevins incubated in the gravel. Data used to evaluate this hypothesis are in Appendix Table D-8.

We found that the abundance of female spawners, intensity of peak flows during gravel incubation of eggs and alevins, and water temperature during gravel incubation of eggs and alevins were related to the number of wild juveniles that passed Savage Rapids Dam. A regression analysis indicated that migrant abundance was positively related to estimates of the number of females alive prior to spawning, and was negatively related to water temperature and the intensity of peak flow (Appendix Table D-9).

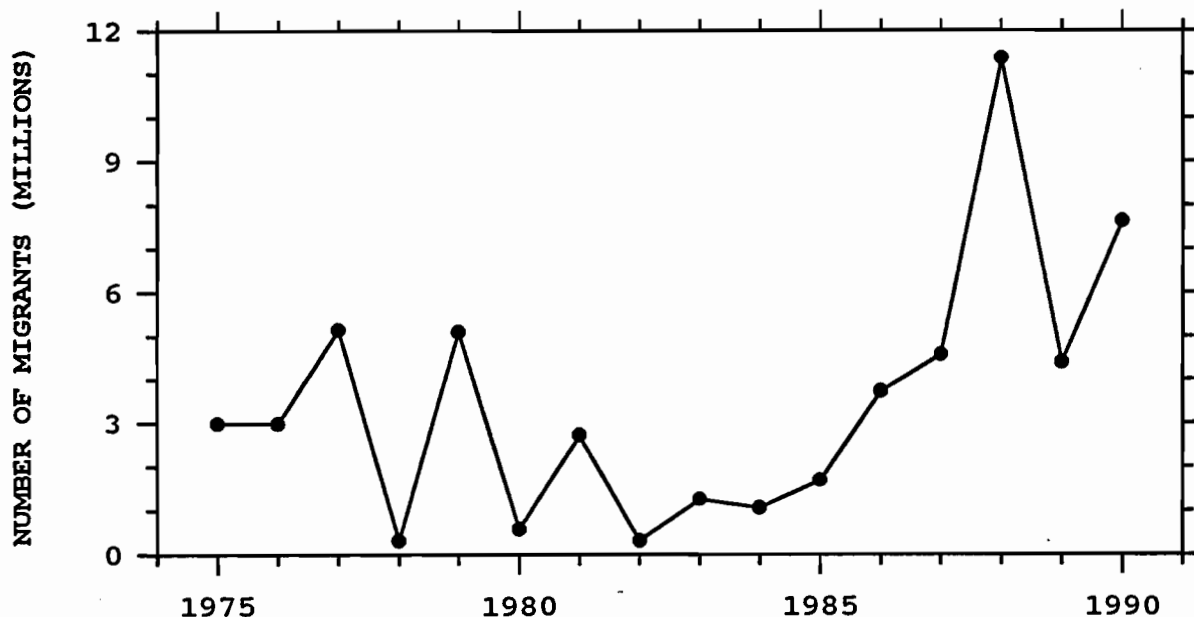

Figure 17. Estimated number of wild subyearling chinook salmon that passed Savage Rapids Dam between 14 May and 30 September, 1975-90.

Of the three independent variables, peak flow was most highly correlated with migrant abundance (Appendix Table D-9). Residual variation from that relationship (Figure 18) was marginally related to annual estimates of the number of females estimated to spawn in areas upstream of Gold Ray Dam (Figure 18). Finally, residual variation from that relationship was significantly related to water temperature when eggs and alevins incubated in the gravel (Figure 18). The relationship between the observed abundance of wild migrants and the number predicted by the regression equation indicated that the regression was effective in the prediction of migrant abundance when less than 6 million migrants passed Savage Rapids Dam (Figure 18).

Results of the multiple regression must be interpreted with caution. Inclusion of three independent variables is probably excessive for a regression analysis with 16 years of data. However, we have some confidence

Table 18. Comparison of the number of juvenile spring chinook salmon released in June from Cole M. Rivers Hatchery and estimates of the number of those fish that subsequently passed Savage Rapids Dam, 1984-88. Data includes marked and unmarked fish. No hatchery fish were released in June of 1985.

Year	Number released from hatchery	Estimated passage at Savage Rapids Dam
1984	774,522	280,328
1986	785,282	739,262
1987	803,040	531,831
1988	127,566	108,754

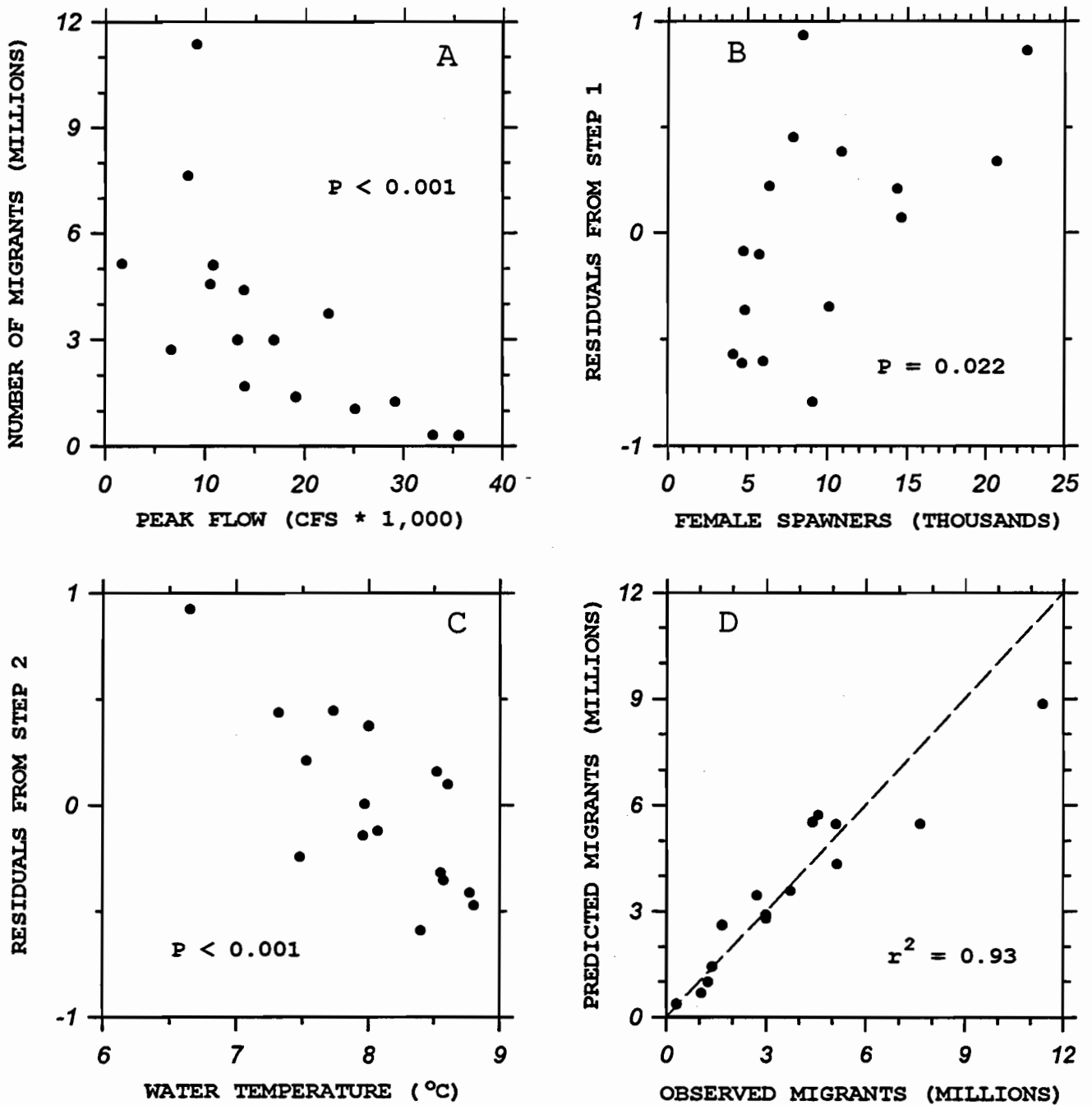

Figure 18. Steps in the analysis of factors related to the number of wild subyearling chinook salmon that passed Savage Rapids Dam, 1975-89 brood years. Variables within plots are (A) annual estimates of the number of migrants and the peak mean daily flow at Raygold during the preceding November-February, (B) residual variation from relationship (A) and the estimated number of female parents that spawned upstream of Gold Ray Dam, and (C) residual variation from relationship (B) and mean maximum water temperature at Raygold in the preceding October-December. Plot D compares values predicted from the regression with observed values.

in the results because (1) findings were very similar to findings from the analysis of catch rates of fry at the seining sites, (2) the effect of each independent variable on salmonid production is documented in the literature, and (3) independent variables in the regression were not intercorrelated (Appendix Table D-10).

In addition, numbers of spawning females, although an independent variable, were not estimated without error. We lacked the data needed to estimate the number of female chinook salmon that spawned between Savage Rapids Dam and Gold Ray Dam. In addition, we had to assume that estimates of harvest rates in the fishery upstream of Gold Ray Dam (see *Harvest Rate*, page 196) and estimates of prespawning mortality rates (see *Prespawning Mortality*, page 162) were accurate, and that 53% of the age 4-6 wild fish and 50% of the age 3-6 hatchery fish were females.

**Discussion:** Our findings suggested that reservoir operation affected the production of wild juvenile chinook salmon in the upper river through changes in the intensity of peak flow and water temperature while eggs and alevins incubated in the gravel, and through multiplicative impacts on the number of females that returned to spawn. A discussion of these effects follows.

First, we concluded that reductions in peak flow that resulted from reservoir operation (see *Flow*, page 56) increased the survival rate of eggs and alevins incubating in the gravel. Results from other research studies support this conclusion.

Egg-to-fry survival rates of chinook salmon increased from 0.2%-7% to 12%-20% after control of freshets by a dam on the Big Qualicum River in British Columbia (Lister and Walker 1966). Survival rates of chinook salmon eggs in Mill Creek, California, averaged 60% during controlled flow, while survival rates of eggs exposed to floods averaged 2% (Gangmark and Bakkala 1960). Wales and Coots (1954) found egg-to-fry survival rates for chinook salmon in Fall Creek, California, ranged between 7% and 32%, with greater survival during a winter of stable flow. Rivers (1964) and Cramer et al. (1985) found a negative relationship between the intensity of peak flow and returns of spring chinook salmon to the Rogue River.

Flooding reduced production of juvenile brook trout (Elwood and Waters 1969; Seegrist and Gard 1972; Erman et al. 1988), chum salmon (Wickett 1958; Montgomery et al. 1996), pink salmon (Wickett 1958), sockeye salmon (Thorne and Ames 1987), and coho salmon (Holtby and Healey 1986; Scrivener and Brownlee 1989). Depending the size of the freshet and the particle size of the substrate within spawning riffles (Giberson and Caissie 1998), freshets can displace eggs and alevins from gravel nests (Montgomery et al. 1996). Embryos are then washed downstream they may be injured (Harvey 1987) or consumed by predators (Wickett 1958).

We also concluded that increases in water temperature that resulted from reservoir operation (see *Water Temperature*, page 56) decreased the survival rate of juvenile spring chinook salmon at some point between the life history stages of fertilized eggs and newly emergent fry. However, this conclusion was more difficult to evaluate as we are uncertain of the causative factor of decreased survival.

Early fry emergence has been implicated as a factor associated with a decrease in the production of coho salmon in coastal streams of Oregon (Nickelson et al. 1986) and British Columbia (Hartman et al. 1996). Graybill (1979) found that warming of the Skagit River in Washington reduced the survival of chinook salmon fry because they emerged one month earlier. Early emergence causes newly emergent salmonid fry to be exposed to more intensive freshets (Hartman et al. 1982) and forces them to obtain their first food at an earlier date (Heming et al. 1982), which has been shown to be an important determinant of survival rates in some fish (Margulies 1989).

Incubation temperatures appear to have more subtle effects on salmonid embryos. Atlantic salmon (*Salmo salar*) alevins incubated as eggs at 8°C had fewer, and smaller, muscle fibers as compared to counterparts incubated as eggs at 4°C (Johnston and McLay 1997). In a similar study, Atlantic salmon embryos incubated at ambient temperatures were longer and heavier as compared to counterparts incubated at warmer temperatures (Nathanailides et al. 1995). In addition, embryos incubated at the warmer temperatures grew slower for at least three weeks after hatching.

Impacts of increased water temperature have also been documented on the early life history stages of non-salmonid fishes. For example, winter flounder (*Pseudopleuronectes americanus*) embryos were larger at the time of first feeding, and had greater levels of protein and genetic material when incubated at lower temperatures as compared to warmer temperatures (Buckley et al. 1990). Field studies such as ours are unlikely to detect such types of impacts unless the effect is indirectly observed via changes in life history parameters such as fry emergence time and spawning time.

Fry of anadromous salmonids tend to emerge at similar times throughout the streams in the Pacific Northwest. Bams (1969) first proposed that salmonid stocks were adapted so that fry emerged at optimal times in specific habitats. Localized adaptations that affect fry emergence timing include: differing developmental rates of eggs and alevins that are temperature independent (Murray et al. 1990), differences in spawning time (Adams et al. 1994; Webb and McLay 1996), and differences in water temperature while eggs and alevins incubate in the gravel (Heggberet 1988; Webb and McLay 1996).

While the negative correlation between water temperature and indexes of juvenile chinook production does not represent causality, changes in spawning time (see Spawning Time, page 173) and spawning distribution (see Spawning Distribution, page 169) indicated that the increases in mortality were greatest among the progeny of early spawners. We also documented that the emergence timing of fry produced by early spawners was most affected by increases in water temperature (see Emergence Timing, page 64). Based on these changes in life history parameters, and the multiple regression analysis, we concluded that the increase in water temperature that resulted from reservoir operation, when embryos incubated in the gravel, decreased the production of wild juvenile spring chinook salmon.

Findings from the multiple regression analysis also indicated that the number of female chinook salmon that spawned was positively related to the number of juveniles produced in the following year. Results from other work tend to support this conclusion. A positive correlation between spawner abundance and resultant juvenile production has been reported for other stocks

of chinook salmon (Major and Mighell 1969; Lindsay et al. 1989; Unwin 1997a). Bjornn (1978) found that the number of eggs deposited by females accounted for 52% of the variation in the number of spring chinook salmon fry that migrated from the Lemhi River in Idaho.

We found no indication that abundance of juvenile chinook salmon reached or exceeded carrying capacity of the upper river in 1975-90. Our analyses indicated that juvenile production increased in a linear manner over the range of spawning escapement (4,000-23,000 females) estimated during the study. However, because there is a finite amount of spawning and rearing habitat, juvenile production must peak at some point or may even decrease at some level of spawning escapement (Ricker 1975). Consequently, years of even larger spawning escapements are needed to identify the density-dependent relationship between spawning escapement and the production of wild juveniles. Until such sampling is conducted, or until carrying capacity is estimated through some type of model based on the amount of habitat available to juvenile chinook salmon, we can only surmise that production of wild juvenile chinook salmon in the upper river will increase when spawning escapement exceeds levels observed in this study.

Finally, we concluded that reservoir operation affected the number of female chinook salmon that spawned in the upper river. We also determined that changes in flow and water temperature affected the number of wild juveniles produced, the maturity rate of chinook salmon (see *Maturity Rates*, page 138), the number of wild chinook salmon harvested in the ocean (see *Ocean Harvest*, page 131), the number of chinook salmon that died in freshwater before spawning (see *Prespawning Mortality*, page 162), and the number of wild chinook salmon harvested in freshwater (see *Harvest*, page 192). In light of the multiple affects of reservoir operation on the number of females that spawned, simulation analysis (see *Simulation Model*, page 201) was required to evaluate the affects of reservoir operation on the production of wild juvenile chinook salmon.

### Dewatering Mortality

We determined that juvenile spring chinook salmon in the Rogue River are susceptible to dewatering mortality when stranded during large changes in flow from Lost Creek Dam. We also found that eggs and alevins of spring chinook salmon are susceptible to being dewatered when the reservoir fills in late winter. In addition to fish, other aquatic organisms are stranded and killed as a result of rapid decreases in flow (Cushman 1985).

Fry were rarely exposed to flow decreases greater than 50 cfs per hour prior to the construction of Lost Creek Dam. However, reservoir outflow decreased from 4,300 cfs at 1100 hours to 2,000 cfs at 2200 hours on 17 April 1985. On 18 April, we surveyed 432 linear meters of dewatered areas and found 88 dead chinook salmon fry and 6 dead yearling salmonids. We also found numerous live and dead cottids. Based on the distance surveyed, we estimated that samplers would have found 21,000 chinook salmon fry dead in dewatered areas if all dewatered areas had been surveyed between Lost Creek Dam and the mouth of the Applegate River.



We concluded that it was unlikely that surveyors located all of the fish that died as a result of dewatering mortality. Some dead chinook salmon fry were found beneath rocks and vegetative material. Only a portion of these types of locations were thoroughly examined. In addition, we observed tracks of likely predators that had moved through the areas prior to our surveys. Thus, we were unable to estimate the efficiency of our surveys and were unable to estimate the total mortality of chinook salmon fry that resulted from dewatering.

The 2,100 cfs decrease in reservoir outflow during an eleven hour period on 17 April 1985 was large in comparison to natural decreases in flow. From 1968 through 1976, the greatest decrease in flow during 24 hours usually did not exceed 800 cfs at Dodge Bridge (Table 19). Consequently, prior to reservoir operation, newly emergent chinook salmon fry were rarely exposed to flow decreases greater than 40 cfs per hour.

On 8 April 1987, we surveyed three gravel bars of low gradient near Takelma Park after river flow at Dodge Bridge decreased from 1,300 cfs to 700 cfs at a rate of about 150 cfs per hour. Changes in reservoir outflow were primarily responsible for the decrease in flow. We found 10 dead chinook salmon fry, and 40 live and dead cottids, in recently dewatered areas. In addition, we judged there were about 6,000 chinook salmon fry trapped in side channels that were isolated from the river channel.

On 27 April 1988, we surveyed two gravel bars of low gradient near Takelma Park after river flow at Dodge Bridge decreased from 2,074 cfs to 1,568 cfs over a period of 24 hours. Changes in reservoir outflow were primarily responsible for the decrease in flow. No dewatered salmonids were found in dewatered areas although we observed about 1,500 chinook salmon fry trapped in side channels that were isolated from the river channel.

Table 19. Largest decrease in daily flow (cfs) during April and May at Dodge Bridge, 1966-76.

	April		May	
	Dates	Flow decrease (cfs)	Dates	Flow decrease (cfs)
1966	11-12	710	06-07	380
1967	19-20	140	10-11	790
1968	06-07	90	21-22	130
1969	02-03	470	14-15	790
1970	11-12	190	09-10	300
1971	10-11	550	13-14	1,150
1972	08-09	340	17-18	440
1973	13-14	270	25-26	400
1974	01-02	4,600	09-10	670
1975	25-26	600	19-20	700
1976	25-26	300	14-15	330

To decrease stranding mortality of juvenile salmonids during operations other than flood control, we recommend that the rate of decrease in reservoir outflow does not exceed a maximum incremental rate of (1) 150 cfs every three hours and (2) 750 cfs daily. However, because this recommendation is based on findings from three cursory surveys, and because stranding probability of salmonids is also affected by channel morphology (Bradford et al. 1995), the USACE should evaluate transect surveys as a means to determine the relationship between flow and gravel coverage in the upper river.

We make no recommendations to minimize the stranding of juvenile salmonids in side channels. Some of these fish may return to the main channel when flow increases either naturally or through reservoir releases. Salvage of stranded fish can be costly (Higgins and Bradford 1996) and may need to be conducted repeatedly as flow changes are common in years of high water yield.

We also found that flood control operations dewatered and killed juvenile salmonids. On 16 December 1982, we found one dead adult summer steelhead and 25 dead juvenile steelhead within a dewatered area between Cole M. Rivers Hatchery and Big Butte Creek. We believe that it is unlikely that there were additional fish mortalities in the area farther downstream because of the simultaneous peak in flow from Big Butte Creek.

However, current USACE guidelines allow for outflow reductions of up to 1,200 cfs per hour as the USACE attempts to return the level of the reservoir to an elevation of 1,812 ft. We believe that it is likely that juvenile salmonids are dewatered and killed during such rapid changes in river flow. As a result, we recommend that the USACE release water stored in the reservoir during flood control operations so that the rate of decrease in reservoir outflow does not exceed the rate of decrease in reservoir inflow following the freshet. If this recommendation is implemented, then the rate of flow decrease after floods would be similar to the natural decrease in flow.

When the reservoir fills, eggs and alevins can also be dewatered and killed before emergence from the gravel if the parents spawned at relatively high flows. We found that the mean depth of redds ranged between 14 and 33 inches at five sites sampled in 1982 and ranged between 19 and 50 inches at six sites sampled in 1983 (Appendix Table D-11). Within years, redd depths varied significantly ( $P < 0.05$ ) among sampling sites (Appendix Table D-11). This finding indicated that the entire spawning area should have been randomly sampled to characterize the depth of redds for the entire population.

Our samples are likely not representative of the entire spawning area because we only sampled upstream of Rogue Elk Park. The river channel farther downstream tends to be less constrained and is characterized by a greater proportion of low gradient gravel bars. These low gradient areas are similar in morphology to spawning areas near Cole M. Rivers Hatchery and near the Obstinate J Ranch. Redd depths at these sites averaged 17 inches (95% CI =  $\pm 4$  inches) and 19 inches (95% CI =  $\pm 2$  inches) respectively in 1982.

Measurements indicated that two of the 16 redds found on the gravel bar across from Cole M. Rivers Hatchery were less than 10 inches deep and that two of 44 redds found near the Obstinate J Ranch were less than 10 inches deep. Given that the authorizing document requires that a minimum reservoir outflow of 700 cfs in February-April, and that the flow of Big Butte Creek often

decreases to about 100 cfs, we recommend that reservoir releases be limited to no more than 1,200 cfs while spring chinook salmon spawn (20 September through 1 November). Implementation of this recommendation should keep the water level from dropping more than 10 inches (25 cm) between spawning and fry emergence, ensuring that a minimum of 90% (4/44) the redds in shallow water areas will be protected from being dewatered while the reservoir fills.

### Growth Rate

**Growth Rate during the Entire Period of Freshwater Residence:** Scale analyses indicated that adult spring chinook salmon of different ages grew at different rates while they were juveniles in freshwater, and that freshwater growth rates varied among years (Table 20). Fish that matured at younger ages grew at faster rates in freshwater as compared to cohorts that matured at older ages. A Newman-Keuls Multiple Range Test indicated that the average spacing of freshwater circuli were significantly greater on scales of (1) age 2 fish as compared to age 3, age 4, and age 5 cohorts, (2) age 3 fish as compared to age 5 cohorts, and (3) age 4 fish as compared to age 5 cohorts (Table 20). We excluded age 6 fish from the analysis because we concluded that there were insufficient data for fish of that age class. Based on these findings, the following comparisons apply only to fish of the same age or only to completed broods. Data included in the analysis are in Appendix Table D-12.

We found that freshwater growth rates of juvenile spring chinook salmon, as indexed by the average spacing of freshwater circuli on scales of returning adult fish, increased significantly after the initial operation of Lost Creek Dam (Table 21). Freshwater growth rates in the later years of reservoir operation decreased and did not differ significantly from those observed before reservoir operation (Table 21).

Table 20. Comparison of the average spacing (mm at 88x) of freshwater circuli on the scales of wild age 2-5 spring chinook salmon, 1972-89 brood years. Brood years with less than 10 samples within any age class were excluded from the analysis. Age classes that share common lines did not differ at  $P < 0.05$  based on a Newman-Keuls Multiple Range Test.

Two factor analysis of variance					
Source of variation	Sum of squares	df	Mean square	F	P
Age class	$2.706 \times 10^{-1}$	3	$0.902 \times 10^{-1}$	5.25	<0.001
Brood year	$6.532 \times 10^{-1}$	14	$0.467 \times 10^{-1}$	10.15	<0.001
Residual	$12.970 \times 10^{-1}$	42	$0.220 \times 10^{-1}$		

Newman-Keuls Multiple Range Test				
	<u>Age 2</u>	<u>Age 3</u>	<u>Age 4</u>	<u>Age 5</u>

Table 21. Comparisons of the average spacing (mm at 88x) of freshwater circuli on scales of wild spring chinook salmon produced before and during reservoir operation. Within rows, means with different superscripts differed at  $P < 0.05$  based on a Newman-Keuls Multiple Range Test. Data included in the analysis are in Appendix Table D-12.

Life history	Brood years			P for difference
	1970-76	1977-84	1985-90	
Complete broods	1.90 <sup>a</sup>	2.13 <sup>b</sup>	1.92 <sup>a</sup>	<0.001
Age 4 adults <sup>c</sup>	1.92 <sup>a</sup>	2.15 <sup>b</sup>	1.93 <sup>a</sup>	0.002

<sup>c</sup> *Subyearling smolts only.*

Based on the change in average spacing of freshwater circuli, we estimated that growth rates of wild juvenile fish averaged 0.803 mm per day before reservoir operation and 0.853 mm per day during the first eight years after reservoir operation. We derived this estimate from the relationship between circuli spacing and body length estimated from juvenile chinook salmon raised in a laboratory (see Growth Rate, page 29).

We hypothesized that three primary factors affected freshwater growth rates: (1) abundance of juvenile chinook salmon, (2) water temperature, and (3) flow. Estimates of circuli spacing were highly correlated for completed broods and for age 4 fish that migrated as subyearling smolts (Appendix Table D-13), so we only analyzed data from completed broods. The two indexes of juvenile abundance developed during the project were also highly correlated (Appendix Table D-13) so we only included migrant numbers as an independent variable. A correlation matrix that outlines the relationships among all variables examined in the analyses of circuli spacing is in Appendix Table D-13. Data included in the analyses are in Appendix Table D-14.

Juvenile abundance and water temperature appeared to be important determiners of growth rate for juvenile spring chinook salmon in the Rogue River. Regression analysis indicated that these two factors accounted for significant amounts of the variation in the average spacing of freshwater circuli for completed broods of wild adults (Appendix Table D-15). Circuli spacing was negatively related to annual number of wild juvenile chinook estimated to have migrated past Savage Rapids Dam (Figure 19). Residual variation from this relationship was positively related to the average water temperature during freshwater residence (Figure 19). Residual variation from that relationship was not significantly related to flow (Appendix Table D-15). The relationship between observed and predicted estimates of average circuli spacing are also presented in Figure 19.

Results of the multiple regression should be interpreted with caution. Inclusion of 2 independent variables may be excessive for a regression analysis with only 16 years of data. However, we have some confidence in the results because the effects of each independent variable on salmonid growth are documented in the literature and the independent variables in the regression were not intercorrelated (Appendix Table D-13).

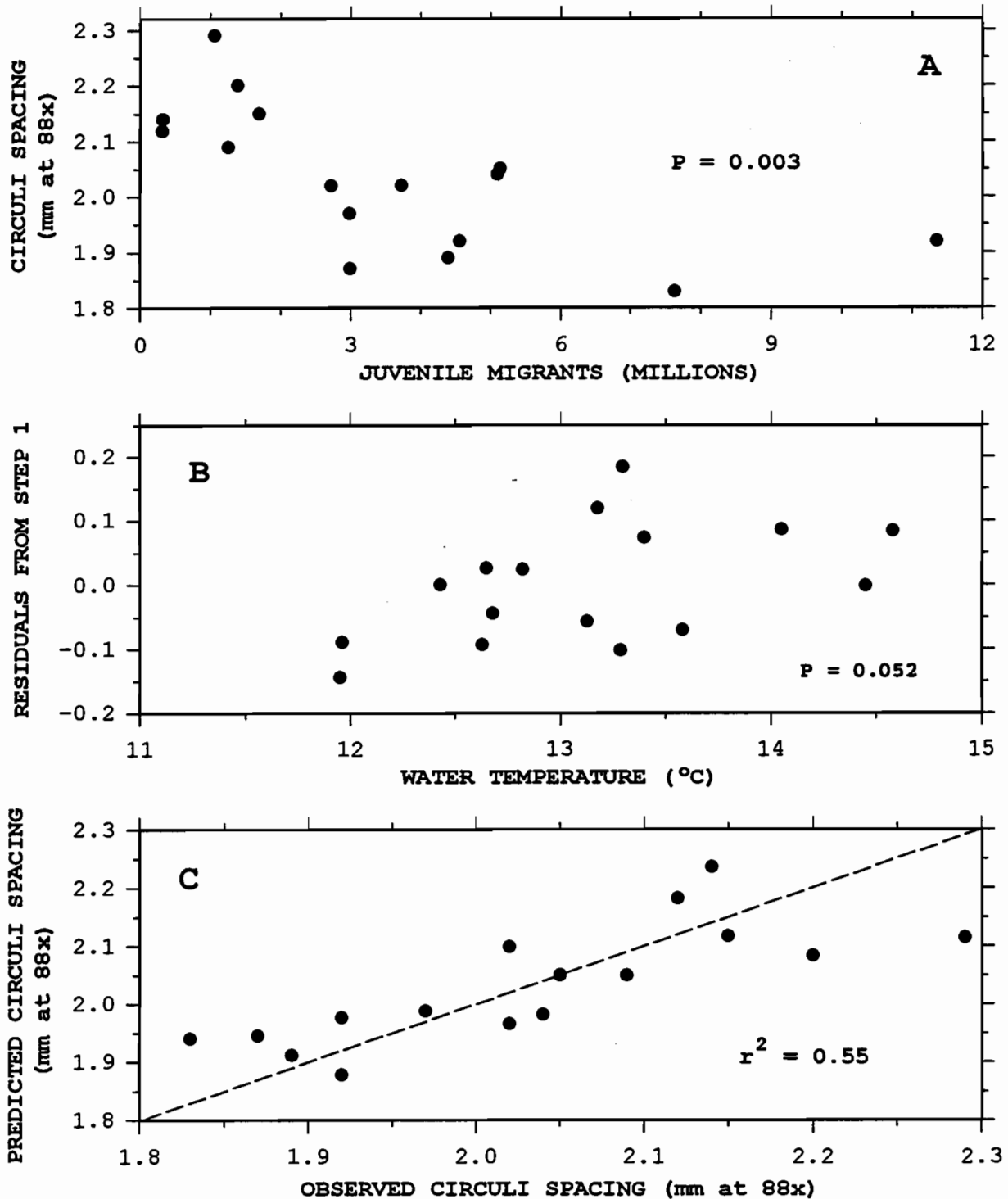

Figure 19. Steps in the analysis of factors related to the freshwater growth rate of wild juvenile spring chinook salmon, 1972-89 brood years. Variables within plots are (A) mean average spacing of freshwater circuli from completed broods of wild adults and the number of migrants estimated to have passed Savage Rapids Dam and (B) residual variation from relationship (A) and the mean maximum water temperature at Dodge Bridge in April-July. Plot C compares values predicted from the regression with observed values.

**Initial Freshwater Growth:** We found that wild juvenile chinook salmon that initially grew faster in freshwater tended to migrate downstream earlier in summer as compared to counterparts that grew at slower rates. Mean widths of circuli bands I+II on scales taken from migrants trapped at Savage Rapids Dam in July through early September decreased significantly through time in two of the three years when at least 18 scale samples were obtained weekly (Figure 20). These findings indicated that growth rates affected the timing of downstream migration of wild juvenile chinook salmon in the Rogue River. Data included in the analyses are in Appendix Table D-16.

Scale analyses also indicated that adult spring chinook salmon of different ages grew at different rates as fry in spring and early summer, and that the initial growth varied between years (Table 22). Fish that matured at younger ages grew at faster rates as fry in comparison to cohorts that matured at older ages. A Newman-Keuls Multiple Range Test indicated that band widths I+II were significantly greater on scales of (1) age 2 fish as compared to age 3, age 4, and age 5 cohorts, (2) age 3 fish as compared to age 5 cohorts, and (3) age 4 fish as compared to age 5 cohorts (Table 22). We excluded age 6 fish from the analysis because we concluded there were insufficient data from fish of that age class. Data included in the analysis are in Appendix Table D-17. Based on these findings, the comparisons that follow apply only to fish of the same age or only to completed broods.

We found that the combined widths of circuli bands I+II increased significantly after the initial operation of Lost Creek Dam (Table 23). Fry growth in the later years of reservoir operation decreased and did not differ significantly from those observed before reservoir operation (Table 23).

Table 22. Comparison of the mean widths (mm at 88x) of circuli bands I+II on the scales of wild age 2-5 spring chinook salmon, 1972-89 brood years. Brood years with less than 10 samples within any age class were excluded from the analysis. Age classes that share common lines did not differ significantly based on a Newman-Keuls Multiple Range Test.

Two factor analysis of variance					
Source of variation	Sum of squares	df	Mean square	F	P
Age class	31.66	3	10.55	9.61	<0.001
Brood year	78.38	14	5.60	18.11	<0.001
Residual	24.48	42	0.58		

Newman-Keuls Multiple Range Test				
	<u>Age 2</u>	<u>Age 3</u>	<u>Age 4</u>	<u>Age 5</u>

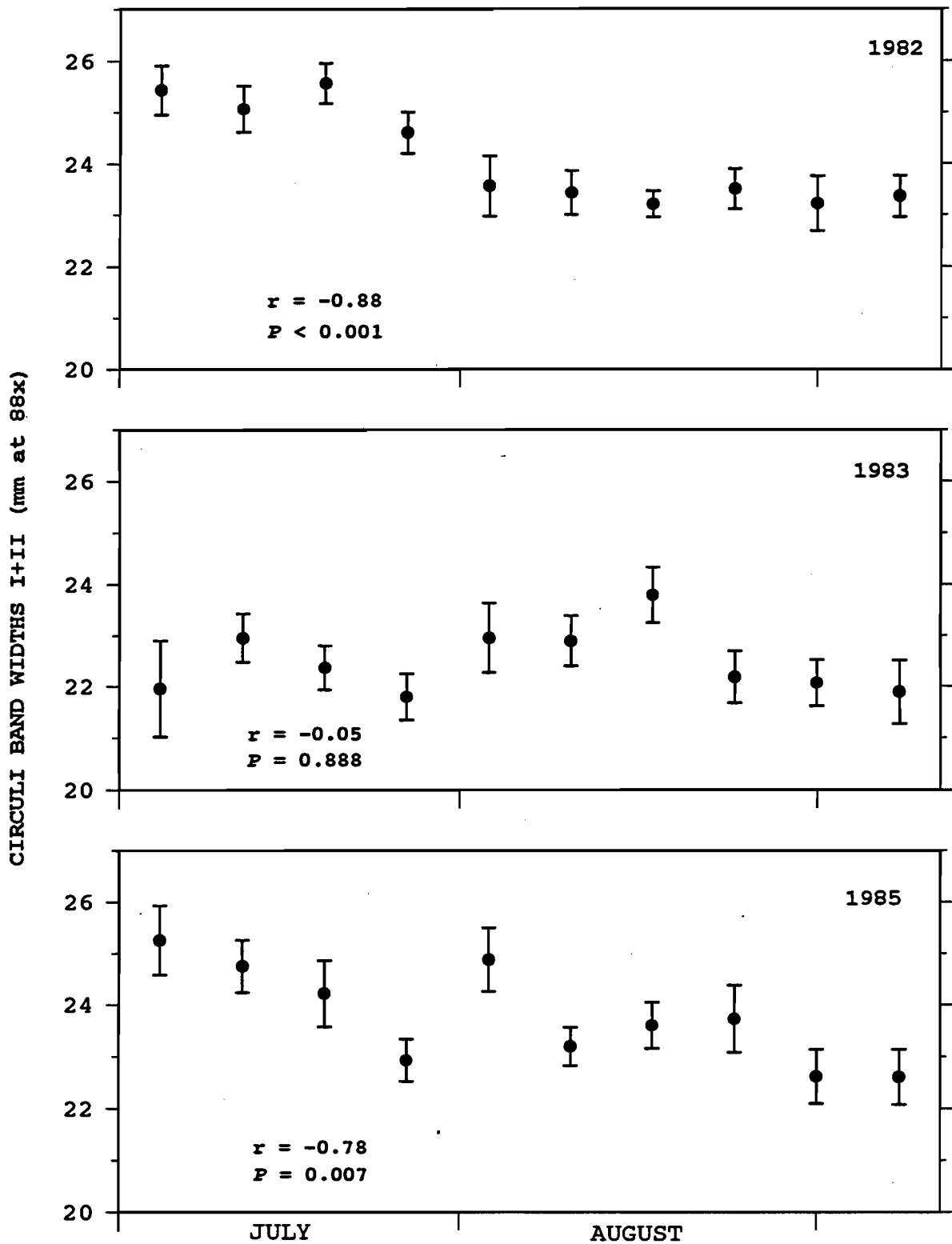

Figure 20. Mean widths of circuli bands I+II on scales of wild juvenile chinook salmon trapped weekly at Savage Rapids Dam, 1982-85. Data from 1984 are not presented because some scale samples may have been taken from unmarked hatchery fish.

Table 23. Comparisons of the mean widths (mm at 88x) of circuli bands I+II on the scales of wild spring chinook salmon produced before and during reservoir operation. Within rows, means with different superscripts differed at  $P < 0.05$  based on a Newman-Keuls Multiple Range Test. Data included in the analysis are in Appendix Table D-17.

Life history	Brood years			P for difference
	1970-76	1977-84	1985-90	
Complete broods	21.46 <sup>a</sup>	23.42 <sup>b</sup>	21.53 <sup>a</sup>	0.006
Age 4 adults <sup>c</sup>	21.82 <sup>a</sup>	23.47 <sup>b</sup>	21.73 <sup>a</sup>	0.016

<sup>c</sup> *Subyearling smolts only.*

We hypothesized that three primary factors affected the initial growth of fry: (1) juvenile abundance, (2) water temperature, and (3) flow. Estimates of band widths I+II were highly correlated for completed broods and for age 4 fish that migrated as subyearling smolts (Appendix Table D-18) so we only analyzed data from completed broods. The two indexes of juvenile abundance were also highly correlated (Appendix Table D-18) so we only included annual indexes of fry abundance as an independent variable. A correlation matrix that outlines the relationships among all variables examined in the analyses of circuli spacing is in Appendix Table D-18. Data included in the analyses are in Appendix Table D-19.

Fry abundance and water temperature appeared to be important determiners of initial freshwater growth. Regression analysis (Appendix Table D-20) indicated that these factors accounted for significant amounts of the variation in the combined widths of circuli bands I+II for completed broods of wild spring chinook salmon. Band widths I+II were negatively related to annual catch rates of fry seined in the upper river and were positively related to water temperature averaged for the period of April through June (Figure 21).

Band widths I+II were most highly correlated with indexes of fry abundance (Appendix Table D-20). Residual variation from this relationship was positively related to water temperature in spring (Figure 21). Residual variation from that relationship was not significantly related to flow during the same period (Appendix Table D-20). The relationship between observed and predicted estimates of band widths I+II is also presented in Figure 21.

Although these findings are commensurate with our findings related to growth rate during the entire period of freshwater residence, results of the multiple regression should be interpreted with caution. Inclusion of two independent variables may be excessive for a regression analysis with only 14 years of data. However, we have some confidence in the results because the effects of each independent variable on salmonid growth are documented in the literature and the independent variables in the regression were not intercorrelated (Appendix Table D-18).

**Discussion:** Our analyses suggested that the operation of Lost Creek Dam affected the growth rate of wild juvenile spring chinook salmon in the upper



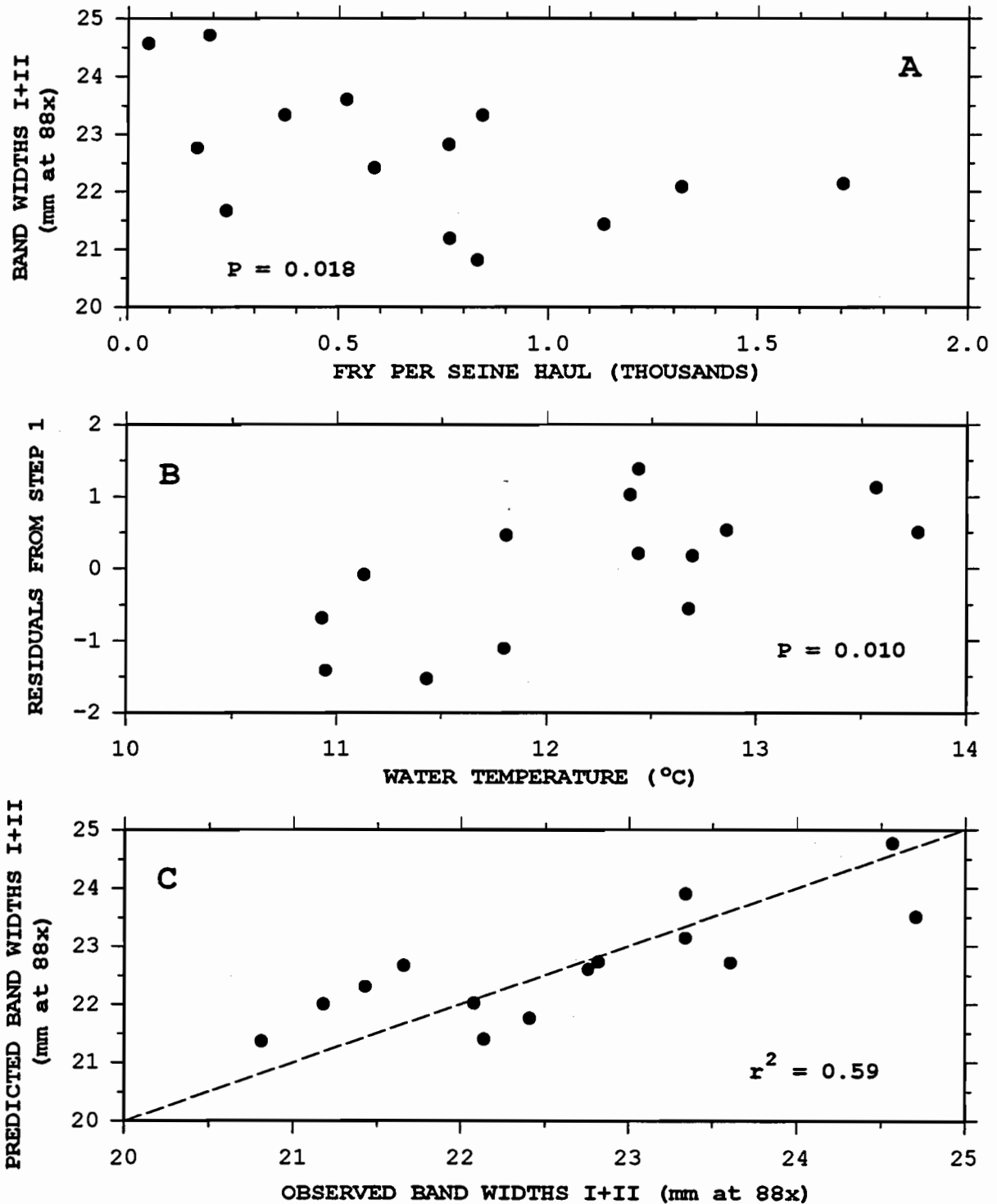

Figure 21. Steps in the analysis of factors related to the initial growth of wild juvenile spring chinook salmon fry, 1972-89 brood years. Variables within plots are (A) mean widths of circuli bands I+II from completed broods of wild adults and the annual catch rate of chinook salmon fry seined at Sand Hole and High Banks, and (B) residual variation from relationship (A) and the mean maximum water temperature at Dodge Bridge in April-June. Plot C compares values predicted from the regression with observed values.

river as a result of changes in water temperature and the impact of reservoir operation on the abundance of juveniles. Results from other research studies supported these conclusions.

Banks et al. (1971) found juvenile chinook salmon grew faster at 15°C compared to 10-13°C or 18°C. Juvenile chinook salmon also grew faster in a heated stream where temperatures peaked at 16°C compared with a control stream where temperatures peaked at 20°C (Bisson and Davis 1976). Brett et al. (1982) presented information that indicated the optimum temperature for growth of juvenile chinook salmon was about 15°C. Greater than optimum temperature decreased efficiency of food conversion.

Effects of fish density on growth rate were less apparent in the literature. Weatherley (1972) concluded that density-dependent effects on growth rate are not always evident in fish populations. However, among Pacific salmon, cohort densities affected growth rates of juvenile sockeye salmon (Kyle et al. 1988) and coho salmon (Scrivener and Anderson 1984).

Among chinook salmon, Bjornn (1978) found a negative correlation between the length and abundance of juveniles that migrated from the Lemhi River, Idaho. Variations in juvenile abundance were associated with a 0.8 cm variation in migrant lengths. Lindsay et al. (1989) reported similar results for juvenile spring chinook that migrated from the Warm Springs River in Oregon. Neilson et al. (1985) found evidence that growth rate of juvenile chinook salmon that reared in the estuary of the Sixes River, Oregon, was density dependent. However, Carl (1984) found no relationship between growth rates and densities of juvenile chinook salmon that reared in two small tributaries of Lake Michigan. These studies indicated that cohort abundance can affect growth rate of juvenile chinook salmon in some ecosystems.

An increase in the food supply was almost certainly another factor responsible for an increase in the growth rate of juvenile chinook salmon in the area near Lost Creek Dam. Dietary analyses indicated that zooplankton produced in the reservoir were the primary items consumed in early summer of 1981 by chinook salmon captured at sites immediately downstream of Lost Creek Dam (Jacobs et al. 1984). Effects of increased forage on the growth rates of juveniles that reared farther downstream remains unknown, but research on other streams (Hynes 1970) suggests that the abundance of zooplankton would decrease rapidly downstream of the reservoir.

The change in growth rate was pronounced near Lost Creek Dam. During summer, mean lengths of juvenile chinook salmon seined at Sand Hole increased at the rate of 0.40 mm/day in 1975-77 as compared to 0.89 mm per day in 1978-82, and mean lengths on 1 July were 2-3 cm longer in 1975-77 as compared to 1978-82 (Cramer et al. 1985). The subsequent change in release strategy during the mid-1980s may have affected the amount of forage available to juveniles that reared immediately downstream from the dam. Attempts to release of colder water required the release of storage from deeper in the reservoir. Depending on the vertical distribution of zooplankton in the reservoir, there could have been a decrease in the abundance of forage items that originated from the reservoir.

Without estimates or indexes of food supply, estimation of the effects of reservoir operation on the growth rate of wild spring juvenile chinook

salmon requires estimation of the effects of reservoir operation on water temperature and juvenile abundance. While the effects of water temperature could be directly estimated, simulation analysis (see Simulation Model, page 201) was required to evaluate the multiplicative effects of reservoir operation on the production of wild juvenile chinook salmon.

### Age at Ocean Entry

We found that most wild juvenile spring chinook salmon produced in the Rogue River entered the ocean during the first year of life. Yearling migrants were relatively rare. At the seining site at High Banks, catch rates of yearlings in spring averaged less than 3% of catch rates of subyearlings during the preceding summer. Scales taken from adult spring chinook salmon also indicated that most juveniles migrated to the ocean as subyearlings.

Subyearling migrants are also the dominant life history type among populations of fall chinook salmon in the Columbia River Basin (Koo and Isarankura 1968) and coastal streams of Oregon (Nicholas and Hankin 1988). Yearling migrants are more prevalent among spring chinook salmon (Rich 1925) and among chinook salmon produced in streams located at higher latitudes (Healey 1983).

Yearling migrants accounted for an average of 1.4% of the fish from the 1972-89 brood years that passed Gold Ray Dam. We estimated that yearling migrants would have composed an average of 6.0% of the adults that would have returned to freshwater in the absence of age-selective mortality in the ocean fisheries and in the lower river fishery. We concluded that estimates adjusted for age-selective mortality more accurately represented the life history composition of spring chinook salmon produced in the Rogue River Basin (see Juveniles, page 23).

The proportion of fish that migrated as yearlings differed significantly among different age classes of spring chinook salmon, and also differed significantly among brood years (Table 24). With the exception of age 4 and age 5 fish, the proportion of yearling migrants differed between each age class (Table 24). Yearling migrants were more common within older age classes than within younger age classes of spring chinook salmon (Table 24). We excluded age 6 fish from the analysis because we concluded there were insufficient data from fish of that age class. Data included in the analyses are in Appendix Table D-21.

We also found that the relative abundance of yearling migrants decreased significantly after the operation of Lost Creek Dam (Table 25). Yearling migrants composed an average of 12.0% of the fish from the 1972-76 broods, but averaged only 3.8% of the fish from the 1977-84 brood years and only 2.5% of the fish from the 1985-89 brood years. These findings suggested that the decrease in freshwater growth rates in the later postimpoundment years (see Growth Rate, page 78) failed to increase the proportion of juveniles that entered the ocean as yearling migrants.

We hypothesized that four primary factors affected the proportion of spring chinook salmon that migrated to the ocean as yearlings: (1) juvenile abundance, (2) freshwater growth rate, (3) water temperature, and (4) flow.

Table 24. Comparison of the proportions of yearling migrants among age 2-5 wild spring chinook salmon, 1972-89 brood years. Age classes that share common lines did not differ significantly based on a Newman-Keuls Multiple Range Test. Proportions were arcsin transformed prior to analysis.

Two factor analysis of variance					
Source of variation	Sum of squares	df	Mean square	F	P
Age class	649.2	3	216.4	12.33	<0.001
Brood year	513.9	17	30.2	1.72	0.049
Residual	894.9	51	17.6		

Newman-Keuls Multiple Range Test

Age 2    Age 3    Age 4    Age 5

The two indexes of juvenile abundance developed during the project were highly correlated (Appendix Table D-22) so we only included migrant numbers as an independent variable. A correlation matrix that outlines the relationships among all variables examined in the analyses is in Appendix Table D-22. Data included in the analyses are in Appendix Table D-23.

We were unable to identify any significant relationships between the proportion of yearling migrants and the independent variables examined in the correlation analyses (Appendix Table D-22) and a multiple regression analysis (all  $P > 0.20$ ). The absence of a significant relationship between growth rate and the proportion of yearlings within the completed broods was unexpected because we found that growth rates affected the smolt ages of fall chinook salmon (ODFW 1992) and summer steelhead (ODFW 1994) of Rogue River Basin origin. Other researchers have reported similar results for Atlantic salmon (Chadwick et al. 1978) and coho salmon (Holtby 1988).

Table 25. Comparison of the mean proportions of yearling migrants among wild spring chinook salmon produced before and during reservoir operation. Means were arcsin transformed prior to analysis. Means with different superscripts differed at  $P < 0.05$  based on a Newman-Keuls Multiple Range Test. Data included in the analysis are in Appendix Table D-21.

Life history	Brood years			P for difference
	1970-76	1977-84	1985-90	
Complete broods	12.8 <sup>a</sup>	3.8 <sup>b</sup>	2.5 <sup>b</sup>	<0.001

We found that yearling migrant life histories did not increase in abundance even though juveniles produced by the 1985-89 brood years grew in freshwater at slower rates. It is possible that, prior to reservoir construction, yearling smolts were produced primarily in the uppermost portion of the Rogue River and that increased forage resources that resulted from reservoir operation (see Discussion:, page 83) caused juveniles in this area to reach minimum size thresholds for smolting in their first year of life, despite the reductions in water temperature during the late spring and early summer.

### Time of Migration

**Passage Timing at Savage Rapids Dam:** The migration timing of wild subyearling chinook salmon at Savage Rapids Dam varied greatly among years. Annual estimates of the percentage of migrants that passed by 17 June ranged between 3% and 74%, while the percentage of migrants that passed by 15 July ranged between 25% and 96% (Table 26). On average, 25% of the migrants passed by 17 June, 60% passed by 15 July, and 85% passed by 19 August (Figure 22).

Fish abundance and growth rate appeared to be the primary factors that affected migration timing at Savage Rapids Dam. We found that the percentage of fish that migrated by the middle of June, and by the middle of July, was positively related to fish abundance and growth rate (Table 27). We also found that the percentage of fish that migrated by the middle of August was positively related to fish abundance and the percentage of fall chinook salmon among parental spawners (Table 27). Indexes of migration timing were not significantly related to water temperature or flow in late spring, or to the emergence time of chinook salmon fry in the upper river (Appendix Table D-24). Data included in these analyses are in Appendix Table D-25.

Changes in flow may have influenced the migration timing of subyearling chinook salmon in the Rogue River. Downstream migration appeared to increase during a freshet in the summer of 1976, similar to findings reported by (Shirvell 1994). However, we consider such an impact unusual because pronounced changes in flow rarely occur in the Rogue River during summer.

Table 26. Annual estimates of the migration timing of subyearling chinook salmon that passed Savage Rapids Dam, 1975-89 brood years.

Brood year	Percent that migrated by			Brood year	Percent that migrated by		
	06/17	07/15	08/15		06/17	07/15	08/15
1975	4%	25%	79%	1983	63%	86%	98%
1976	--	--	--	1984	16%	65%	89%
1977	7%	59%	75%	1985	3%	52%	87%
1978	12%	52%	86%	1986	21%	81%	94%
1979	21%	49%	74%	1987	74%	95%	99%
1980	--	--	--	1988	5%	44%	80%
1981	3%	35%	90%	1989	68%	91%	96%
1982	30%	41%	52%				

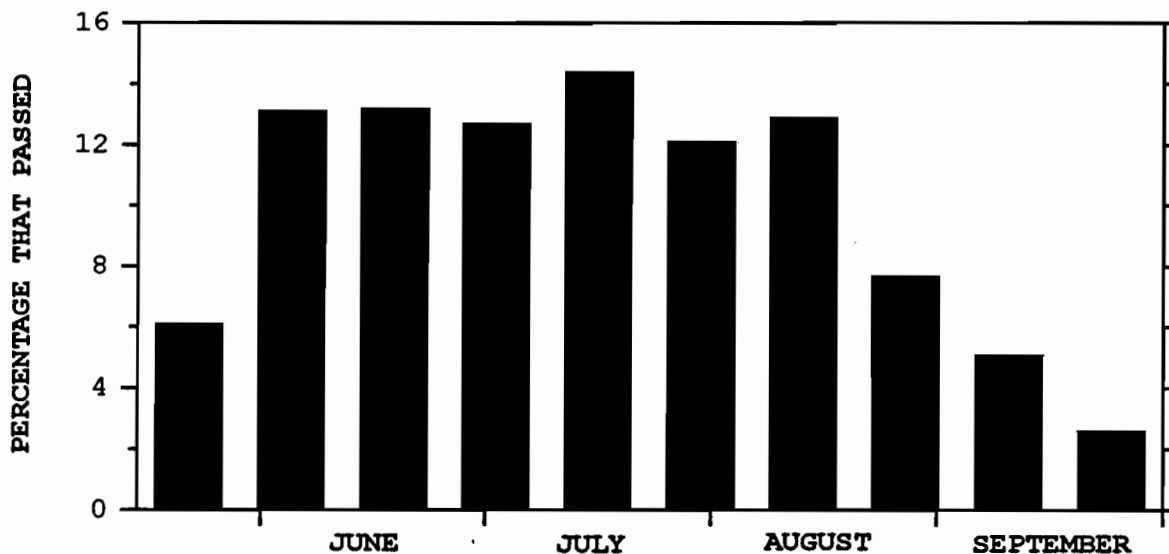

Figure 22. Mean migration time of wild subyearling chinook salmon that passed Savage Rapids Dam between 14 May and 30 September, 1975-89 brood years.

Table 27. Summary of regression analyses for factors related to the migration timing of subyearling chinook salmon that passed Savage Rapids Dam, 1975-89 brood years. Percentages were transformed to logits prior to analysis. Data are described in Table 26 and Appendix Table D-25.

Dependent variable	$r^2$	Independent variable	Regression coefficient	Standard error	$P$
% migration by 06/17	0.51	Juvenile abundance	$5.407 \times 10^{-7}$	$1.431 \times 10^{-7}$	0.004
		Circuli spacing	9.785	3.442	0.018
		Constant	-23.598		
% migration by 07/15	0.57	Juvenile abundance	$4.220 \times 10^{-7}$	$1.031 \times 10^{-7}$	0.002
		Circuli spacing	5.608	2.480	0.047
		Constant	-12.455		
% migration by 08/19	0.63	Juvenile abundance	$3.294 \times 10^{-7}$	$0.764 \times 10^{-7}$	0.002
		Spawner composition (%)	1.954	0.624	0.011
		Constant	3.515		

**Time of Ocean Entry:** Scale analyses suggested that wild juvenile spring chinook salmon that entered the ocean as yearlings migrated from freshwater primarily in May and June. For the seven brood years where we obtained scales from a minimum of 10 fish that migrated as yearlings, we estimated that the mean date of ocean entry was 30 May (95% CI = +17 days). Minimal variation in the estimated dates of ocean entry conforms with the conclusion of (Clarke et al. 1994) that the migration timing of yearling chinook salmon is a genetic based response to changes in photoperiod.

In contrast to yearling migrants, subyearling migrants primarily entered the ocean between August and October (Appendix Table D-26). We estimated that the mean date of ocean entry ranged between 10 August and 27 October for fish of all smolt ages from the 1973-80 broods (Appendix Table D-26). Mean dates of ocean entry differed significantly among brood years and also differed significantly among different age classes of adults (Table 28). Juveniles destined to mature as age 2 adults entered the ocean at an earlier date as compared to cohorts that matured at ages 3-5 (Table 28). We did not include age 6 adults in this analysis because sample sizes were usually too small to estimate the date of ocean entry for this age class. Data included in the analyses are in Appendix Table D-26.

Juvenile spring chinook salmon entered the ocean earlier after the initial operation of Lost Creek Dam (Table 29). Mean date of ocean entry for fish of both smolt ages averaged 12 October (95% confidence interval = +18 days) for the 1973-76 brood years and 26 August (95% CI = +23 days) for the 1977-80 brood years. We were unable to estimate the date of ocean entry for broods produced in later years because we did not collect scales from juvenile chinook salmon. Scale samples from juvenile fish were required to appropriately estimate the date of ocean entry from the number of freshwater circuli on scales of adult fish (see Date of Ocean Entry, page 31). A summary of the numbers of freshwater circuli on scales of wild adult spring chinook salmon are in Appendix Table D-27.

The change in time of ocean entry was also evident within a single age class of wild fish. Mean dates of ocean entry for subyearling smolts that matured at age 4 averaged 9 September (95% confidence interval = +27 days) for the 1973-76 brood years and 8 August (95% confidence interval = +15 days) for the 1977-80 brood years. The difference in means was significant at  $P = 0.064$ . Data included in the analyses are in Appendix Table D-26.

Table 28. Comparison of the mean date of ocean entry for wild age 2-5 spring chinook salmon, 1972-89 brood years. Brood years with less than 10 samples within any age class were excluded from the analysis.

Two factor analysis of variance					
Source of variation	Sum of squares	df	Mean square	F	P
Age class	5,685	3	1,895	5.78	<0.001
Brood year	11,472	7	1,639	6.68	0.002
Residual	5,958	21	284		

Newman-Keuls Multiple Range Test				
	Age 2	Age 3	Age 4	Age 5

Table 29. Comparisons of the mean date of ocean entry for wild spring chinook salmon produced before and during reservoir operation. Data included in the analysis are in Appendix Table D-26.

Life history	Brood years		P for difference
	1973-76	1977-80	
Complete broods	10/12	08/26	0.002
Age 4 adults <sup>a</sup>	09/11	08/20	0.054

<sup>a</sup> *Subyearling smolts only.*

We hypothesized that four primary factors affected the date when wild spring chinook salmon entered to ocean: (1) juvenile abundance, (2) freshwater growth rate, (3) water temperature, and (4) flow. A correlation matrix that outlines the relationships among all variables examined in the analyses is in Appendix Table D-28. Data included in the analyses are in Appendix Table D-29.

Freshwater growth rate and water temperature appeared to be important determiners of when juveniles entered the ocean. Regression analysis (Appendix Table D-30) indicated that these factors accounted for 88% of the variation in the mean dates of ocean entry estimated for complete broods of wild spring chinook salmon.

Date of ocean entry was most highly correlated with the average spacing of freshwater circuli (Appendix Table D-30). Residual variation from this relationship was positively related to the water temperature in the upper river during July and August (Figure 23). The relationship between observed and predicted estimates of mean date of ocean entry are also presented in Figure 23.

However, results of the multiple regression should be interpreted with caution. Inclusion of two independent variables is excessive for a regression analysis with only eight years of data. However, we have some confidence in the results because (1) scale samples taken from juvenile chinook salmon indicated that faster growing fish migrated earlier in summer (see *Initial Freshwater Growth*: page 81), (2) the effect of growth rate on time of smolting is documented in the literature, and (3) independent variables in the regression were not significantly correlated (Appendix Table D-28).

**Discussion:** We found that juvenile spring chinook salmon migrated from the Rogue River at a time similar to other coastal populations of chinook salmon in Oregon (Reimers and Loeffel 1967; Reimers 1973; Nicholas and Hankin 1988). However, subyearlings in the Rogue River migrated later than other populations of chinook salmon. Juveniles that reared in estuaries of the Nanaimo (Healey 1980) and Campbell (Levings et al. 1986) rivers of British Columbia entered the ocean mostly during June-July. An August-October migration timing of juvenile spring chinook salmon in the Rogue River conforms to a definition of river smolts proposed by Carl and Healey (1984), except that juveniles reared in the Rogue River Basin for 4-5 months rather than two months.



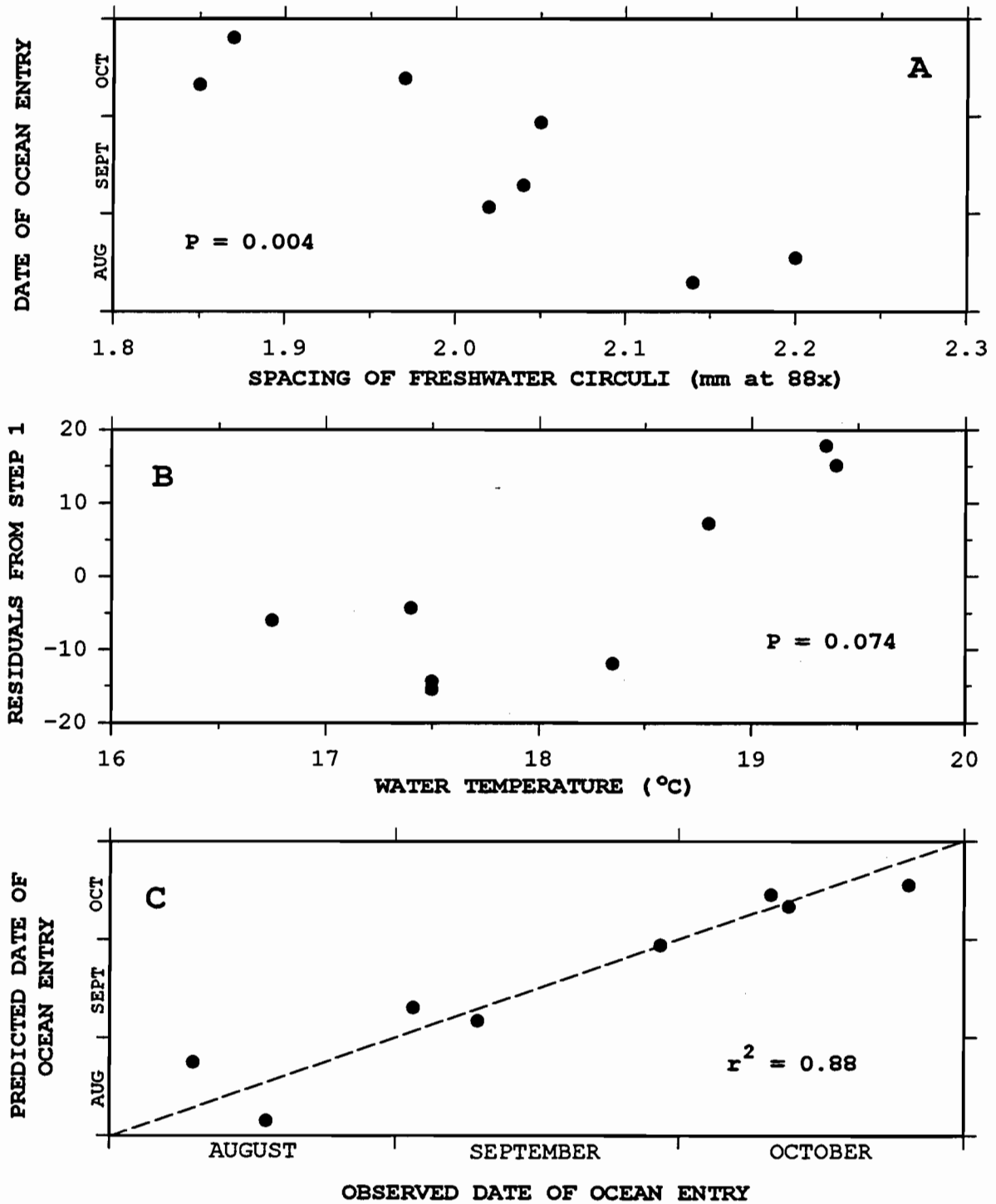

Figure 23. Steps in the analysis of factors related to the timing of ocean entry for wild juvenile spring chinook salmon, 1973-80 brood years. Variables within plots are (A) mean date of ocean entry and the average spacing of freshwater circuli from adult fish that migrated as subyearlings, and (B) residual variation from relationship (A) and the mean maximum water temperature at Raygold in July-August. Plot C compares values predicted from the regression with observed values.

Migration timing is associated with physiological changes in juvenile chinook salmon. Buckman and Ewing (1982) found that specific activity of the (Na+K)-ATPase enzyme in gills of juvenile chinook salmon captured just upstream of the mouth of the Rogue River peaked coincidentally with the peak in time of ocean entry as estimated from scales of adult spring chinook salmon. Increases in the activity of this enzyme are associated with physiological modifications required for the transition from fresh water to salt water (Folmar and Dickhoff 1980).

Peaks in specific activity of (Na+K)-ATPase in juvenile spring chinook salmon reared at Cole M. Rivers Hatchery were associated with attainment of a minimum size of 9 cm and onset of autumn equinox (Ewing et al. 1979). Bjornn (1971) postulated that photoperiod and possibly growth were the primary factors that affected migration timing of juvenile chinook salmon in the Lemhi River of Idaho. Bjornn (1971) also concluded that water temperature, cover, food, and population density were less important determiners of migration timing. Schluchter and Lichatowich (1977) proposed that juvenile spring chinook salmon in the Rogue River needed to reach a minimum size threshold prior to migration from fresh water. Jonasson and Lindsay (1988) and Beckman et al. (1998) found that larger spring chinook salmon migrated downstream earlier than smaller cohorts. Juvenile spring chinook salmon produced after the initial operation of Lost Creek Dam reached a minimal threshold size for smolting more quickly because they grew faster as compared to counterparts produced before reservoir operation (see Growth Rate, page 78).

Our analyses suggested that reservoir operation affected the date of ocean entry by juvenile spring chinook salmon through changes in juvenile growth rate and water temperature during summer. Estimation of the effects of reservoir operation on water temperature could be directly estimated, but simulation analysis (see Simulation Model, page 201) was required to evaluate the effects of reservoir operation on growth rates. Simulations were needed because of the multiplicative effects of reservoir operation on juvenile abundance, which was a primary determiner of freshwater growth rates of wild juvenile chinook salmon (see Growth Rate, page 78).

### Size at Time of Migration

**Size at Savage Rapids Dam:** Estimates of mean lengths for wild subyearling chinook salmon from the 1975-89 brood years ranged between 8.0 and 10.9 cm annually (Appendix Table D-31). Mean lengths were negatively related to annual estimates of the number of migrants ( $r = -0.77$ ,  $P < 0.001$ ) and were positively related to annual rates of freshwater growth as indexed by the average spacing of circuli ( $r = 0.66$ ,  $P < 0.001$ ). Mean lengths of migrants were not significantly related to water temperature and flow in late spring, or to the proportion of fall chinook salmon among parents that spawned upstream of Gold Ray Dam (Appendix Table D-32).

We compared the mean lengths of subyearlings that passed Savage Rapids Dam with the mean lengths of cohorts at the time of ocean entry, as estimated from scales taken from returning adults. We found that estimates of mean lengths at ocean entry were an average of 1.0 cm (95% CI = +0.4 cm) larger than mean lengths of migrants that annually passed Savage Rapids Dam. Annual differences in the length estimates ranged between -0.3 cm and 2.3 cm.

**Size at Ocean Entry:** Fish length at the time of ocean entrance was estimated from radius measurements of the freshwater portion of scales taken from wild adult spring chinook salmon sampled in 1974-94. Summaries of those measurements of scale radii are in Appendix Table D-33.

We estimated that mean lengths of wild juvenile spring chinook salmon from the 1972-89 broods at the time of ocean entry ranged between 9.7 and 11.7 cm (Appendix Table D-34). These results indicated that juvenile spring chinook salmon migrated from the Rogue River at sizes comparable to those that migrated from other coastal streams of Oregon (Reimers and Loeffel 1967; Reimers 1973; Reimers and Concannon 1977; Nicholas and Hankin 1988).

We found that mean lengths at ocean entry differed significantly among brood years, but that mean lengths at ocean entry did not differ significantly among juveniles that matured at different ages (Table 30). We excluded age 6 fish from the analysis because we concluded there were insufficient data from fish of that age class. Data included in the analysis are in Appendix Table D-34.

There was a indication that wild juveniles entered the ocean at a larger size after the initial operation of Lost Creek Dam. Although the change could not be detected among completed broods, age 4 adults that entered the ocean as subyearlings were significantly larger in the years just after reservoir operation in comparison to counterparts produced in years prior to reservoir operation (Table 31). In later years of reservoir operation, juveniles entered the ocean at a mean size similar to counterparts produced in years prior to reservoir operation (Table 31).

We hypothesized that four primary factors affected juvenile length at ocean entry: (1) juvenile abundance, (2) freshwater growth rate, (3) water temperature, and (4) flow. Estimates of circuli spacing were highly correlated for completed broods and for age 4 fish that migrated as subyearling smolts ( $r = 0.83$ ,  $P < 0.001$ ) so we only analyzed data from completed broods. The two indexes of juvenile abundance were also highly correlated (Appendix Table D-35) so we only included migrant numbers as an independent variable. A correlation matrix that outlines the relationships among all variables examined in the analyses of circuli spacing is in Appendix Table D-35. Data included in the analyses are in Appendix Table D-36.

Table 30. Comparison of the mean length (cm) at ocean entry for wild age 2-5 spring chinook salmon, 1972-89 brood years. Brood years with less than 10 samples within any age class were excluded from the analysis.

Two factor analysis of variance					
Source of variation	Sum of squares	df	Mean square	F	P
Age class	1.259	3	0.420	1.88	0.147
Brood year	14.697	14	1.050	4.71	<0.001
Residual	9.358	42	0.223		

Table 31. Comparisons of the mean length (cm) at ocean entry for wild spring chinook salmon produced before and during reservoir operation. Within rows, means with different superscripts differed at  $P < 0.05$  based on a Newman-Keuls Multiple Range Test. Data included in the analysis are in Appendix Table D-34.

Life history	Brood years			P for difference
	1970-76	1977-84	1985-90	
Complete broods	10.53 <sup>a</sup>	10.93 <sup>a</sup>	10.16 <sup>a</sup>	0.057
Age 4 adults <sup>c</sup>	10.17 <sup>a</sup>	10.93 <sup>b</sup>	10.05 <sup>a</sup>	0.040

<sup>c</sup> *Subyearling smolts only.*

We were unable to determine the primary factor that affected juvenile length at the time of ocean entry. Mean lengths at ocean entry were positively correlated with freshwater growth rate ( $r = 0.69$ ,  $P = 0.002$ ) and river flow in summer ( $r = 0.58$ ,  $P = 0.013$ ), and were negatively correlated ( $r = -0.65$ ,  $P = 0.006$ ) with the estimated number of juveniles that passed Savage Rapids Dam (Appendix Table D-35). Multiple regression analysis failed to detect any significant relationships other than those detected by correlation analysis.

Lindsay et al. (1989) also found a negative correlation between size and the number of juvenile spring chinook that migrated from the Warm Spring River, Oregon. Their findings, and our findings, probably are the result of slower growth rates at greater fish densities. Body size appears to affect maturity rates of spring chinook salmon of Rogue River origin (see *Maturity Rates*, page 138), but were unable to identify the affect of variations in size at ocean entry on the abundance, maturation rates, or other life history parameters of wild smolts produced in the upper river.

## ADULTS

### Abundance at Gold Ray Dam

We estimated that an average of 31,000 spring chinook salmon and that an average of 3,300 fall chinook salmon passed Gold Ray Dam annually in 1942-94. Annual returns of spring chinook salmon varied between 6,000 and 90,000 fish, while annual returns of fall chinook salmon varied between 700 and 14,000 fish (Appendix Table E-1). Combined returns of both races of chinook salmon ranged between 15,000 and 103,000 fish (Appendix Table E-1).

**Spring Chinook Salmon:** Passage estimates of spring chinook salmon peaked in the late 1980s at about 90,000 fish. The fewest fish (about 6,000) returned in 1992. Periods when returns decreased below 20,000 fish occurred in the 1950s, the early 1970s, and the early 1990s (Figure 24).

Hatchery fish began to contribute appreciably to the returns in the late 1970s (Figure 24). Increased releases of hatchery smolts, to mitigate for spawning habitat blocked by Lost Creek Dam, were responsible for the increase

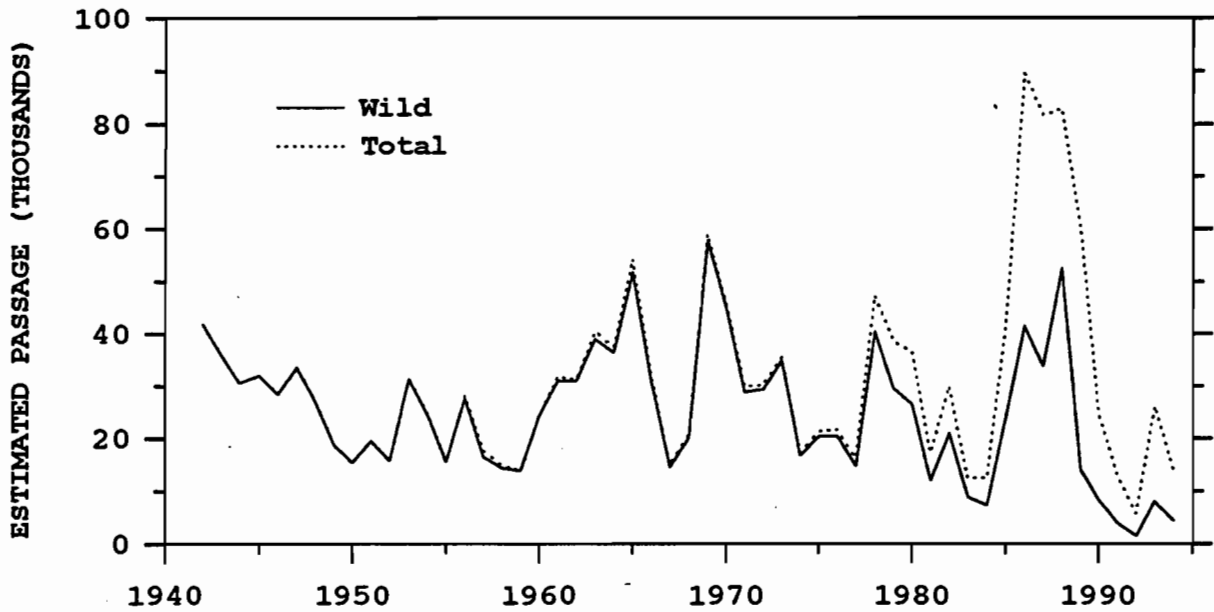

Figure 24. Estimated numbers of spring chinook salmon that passed Gold Ray Dam, 1942-94.

in numbers of hatchery fish that passed Gold Ray Dam. Estimates of the numbers of wild and hatchery fish that passed Gold Ray Dam in 1953-94 are in Appendix Table E-2. The number of hatchery fish that passed Gold Ray Dam in 1942-52 could not be estimated from available data.

Correlation analysis indicated there was no significant change ( $r = 0.07$ ,  $P = 0.743$ ) in the annual returns of spring chinook salmon during the years 1970-94. However, returns of wild fish decreased significantly during the same time period ( $r = -0.46$ ,  $P = 0.020$ ). Returns of wild fish also decreased significantly during 1942-59 ( $r = -0.76$ ,  $P < 0.001$ ). This analysis assumes that all spring chinook salmon were of wild origin in 1942-52.

Estimates of the numbers of age 2-6 wild and hatchery spring chinook salmon that passed Gold Ray Dam in 1974-94 are in Appendix Tables E-3 and E-4. We derived these estimates from (1) passage estimates at Gold Ray Dam (Appendix Table E-2), (2) length frequency distributions of marked and unmarked spring chinook salmon trapped at Gold Ray Dam (Appendix Tables E-5 and E-6), and (3) estimates of the age composition of wild fish, unmarked hatchery fish, and marked hatchery fish (Appendix Tables E-7 through E-9).

A comparison of returns of wild spring chinook salmon to Gold Ray Dam and to Winchester Dam on the North Umpqua River also suggested that the operation of Lost Creek Dam affected the production of wild spring chinook salmon in the Rogue River. Because annual estimates of age composition were not available for spring chinook salmon in the North Umpqua River, or for spring chinook salmon in the Rogue River before 1974, we assumed that the fish counted in both rivers prior to 1981 were produced before the operation of Lost Creek Dam. Estimates of spring chinook salmon that returned to the North Umpqua River were received from David Loomis, ODFW, Roseburg, on 16 May, 1996.

The Rogue River component averaged 83% (95% CI = +2%) of the combined returns of wild spring chinook salmon to both rivers in 1946-80 and 69% (95% CI = +7%) of the combined returns to both rivers in 1981-94. A t-test of arcsin transformed data indicated that the means differed significantly ( $P < 0.001$ ). This finding suggested that construction and operation of Lost Creek Dam was associated with a decrease in the production of wild spring chinook salmon in the Rogue River.

Returns of wild spring chinook salmon in 1981-94 averaged about 5,400 fish in the North Umpqua River and averaged about 17,300 fish at Gold Ray Dam. Assuming that the Rogue River component of the combined returns to both rivers would have been 83% had Lost Creek Dam not been built, we estimate that returns to Gold Ray Dam would have averaged about 26,400 wild spring chinook salmon annually in 1981-94. The difference between the observed and the predicted returns suggested that the construction and operation of Lost Creek Dam reduced returns of wild spring chinook salmon to Gold Ray Dam by an average of 9,100 fish annually in 1981-94. This finding assumes that the populations in both rivers would have continued to covary in 1981-94 had Lost Creek Dam not been built. Such an assumption is difficult to evaluate, but similar analyses showed no significant decreases in the Rogue River components of wild winter steelhead (ODFW 1990) or summer steelhead (ODFW 1994).

Hatchery fish produced to mitigate for blocked spawning habitat compensated for the decrease in returns of wild spring chinook salmon. We estimate that an average of 16,700 spring chinook salmon of hatchery origin returned to Gold Ray Dam in 1981-94. This estimate only includes fish raised to mitigate for blocked spawning habitat (August-March releases). Data included in this analysis are in Appendix Table E-4.

**Fall Chinook Salmon:** Passage estimates of fall chinook salmon peaked in the late 1980s at about 14,000 fish and again in 1994 at about 12,000 fish (Figure 25). Few fall chinook salmon were of hatchery origin, except during the late 1980s. These fish were raised at Cole M. Rivers Hatchery to supplement (not mitigate) the run of fall chinook salmon in the Rogue River.

Numbers of fall chinook salmon that passed Gold Ray Dam did not change significantly ( $r = -0.07$ ,  $P = 0.744$ ) during 1942-69 when annual returns averaged about 1,400 fish. However, annual returns increased significantly ( $r = 0.61$ ,  $P = 0.001$ ) during 1970-94 (Figure 25). Regression analysis indicated that the annual rate of increase was 217 (SE = 59) fish during this period. Data included in these analyses are in Appendix Tables E-1 and E-2.

Estimates of the number of age 2-6 wild and hatchery fall chinook salmon that passed Gold Ray Dam in 1974-94 are in Appendix Table E-10. These estimates were developed from (1) passage estimates at Gold Ray Dam (Appendix Table E-2), (2) length frequency distributions of marked and unmarked fall chinook salmon trapped at Gold Ray Dam (Appendix Tables E-11 and E-12) and (3) estimates of the age composition of wild fish, unmarked hatchery fish, and marked hatchery fish (Appendix Tables E-13 and E-14).

A comparison of returns of wild fall chinook salmon to Gold Ray Dam and wild spring chinook salmon to Winchester Dam on the North Umpqua River also suggested that the operation of Lost Creek Dam affected the production of wild fall chinook salmon in the upper portion of the Rogue River. Wild fall

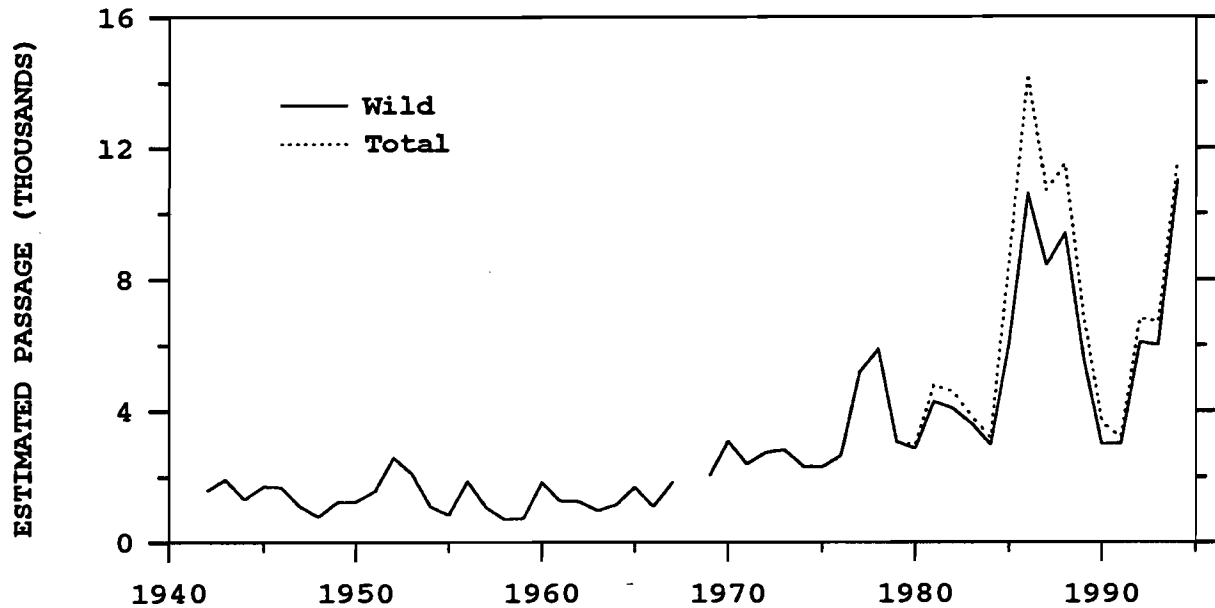

Figure 25. Estimated numbers of fall chinook salmon that passed Gold Ray Dam, 1942-94.

chinook salmon that passed Gold Ray Dam averaged 27% (95% CI = +3%) of the combined returns to both rivers in 1946-80 and 52% (95% CI = +7%) of the combined returns to both rivers in 1981-94. A t-test of arcsin transformed data indicated that the means differed significantly ( $P < 0.001$ ). This finding suggested that construction and operation of Lost Creek Dam was associated with an increase in the production of wild fall chinook salmon in area upstream of Gold Ray Dam.

Returns of wild spring chinook salmon in 1981-94 averaged about 5,400 wild spring chinook salmon in the North Umpqua River and returns of wild fall chinook salmon averaged about 6,000 fish at Gold Ray Dam. Assuming that the Rogue River component of the combined returns to both rivers would have been 27% had Lost Creek Dam not been built, we estimate that returns to Gold Ray Dam would have averaged about 2,000 wild fall chinook salmon annually in 1981-94. The difference between the observed and the predicted returns suggested that the construction and operation of Lost Creek Dam increased returns of wild fall chinook salmon to Gold Ray Dam by an average of 4,000 fish annually in 1981-94.

**All Chinook Salmon:** Passage estimates of both races of chinook salmon peaked in 1986 at about 104,000 fish. As with spring chinook salmon, the lowest returns to Gold Ray Dam occurred in the 1950s, in the early 1970s, and in the early 1990s (Appendix Table E-1). In contrast to spring chinook salmon, there was no significant change ( $r = -0.33$ ,  $P = 0.105$ ) in the annual returns of all wild chinook salmon during 1970-94. This finding may indicate that the total production of wild chinook salmon did not change in the upper river after operation of Lost Creek Dam.

However, a comparison of returns of all wild chinook salmon (spring and fall races) to Gold Ray Dam and wild spring chinook salmon to Winchester Dam on the North Umpqua River suggested that the operation of Lost Creek Dam

affected the production of wild chinook salmon in the Rogue River. Wild chinook salmon that passed Gold Ray Dam averaged 84% (95% CI = +2%) of the combined returns to both rivers in 1946-80 and 78% (95% CI = +4%) of the combined returns to both rivers in 1981-94. A t-test of arcsin transformed data indicated that the means differed significantly ( $P < 0.001$ ). This finding suggested that construction and operation of Lost Creek Dam was associated with a decrease in the production of wild chinook salmon in area upstream of Gold Ray Dam.

Returns of wild spring chinook salmon in 1981-94 averaged about 5,400 wild spring chinook salmon in the North Umpqua River and returns to Gold Ray Dam averaged about 23,300 wild chinook salmon. Assuming that the Rogue River component of the combined returns to both rivers would have been 84% had Lost Creek Dam not been built, we estimate that returns to Gold Ray Dam would have averaged about 28,400 wild chinook salmon annually in 1981-94. The difference between the observed returns and the predicted returns suggested that the construction and operation of Lost Creek Dam reduced returns of wild chinook salmon to Gold Ray Dam by an average of 5,100 fish annually in 1981-94.

Similar to our findings, Bradford (1994) reported that, relative to cohorts produced in nearby rivers, the production of wild chinook salmon decreased in the Nechako River, British Columbia, after construction of a dam in the upper portion of the river. This type of analysis, a comparison of pre- and post- conditions relative to a statistical control, has a greater chance of detecting changes as compared an analysis of pre- and post-conditions only (Smith et al. 1993; Korman and Higgins 1997).

Hatchery fish produced to mitigate for blocked spawning habitat compensated for the decrease in returns of wild chinook salmon. We estimate that an average of 16,700 spring chinook salmon of hatchery origin returned to Gold Ray Dam in 1981-94. This estimate only includes fish raised to mitigate for blocked spawning habitat (August-March releases). Data included in this analysis are in Appendix Table E-4.

We did not further analyze the number of chinook salmon that passed Gold Ray Dam because large numbers died in some years before reaching the counting station (see *Prespawning Mortality*, page 162) and because older fish were selectively harvested in the lower river (see *Fishery Selectivity*, page 198).

#### **Abundance at Cole M. Rivers Hatchery**

Numbers of adult chinook salmon that entered Cole M. Rivers Hatchery varied greatly during 1974-94. Annual returns ranged between 2,406 and 37,967 fish and averaged 10,633 fish. Assuming that 10 October was an appropriate date to segregate the fall race from the spring race, we estimated that an average of 263 fall chinook salmon and 10,370 spring chinook salmon (1,937 jacks and 8,433 adults) entered the hatchery annually in 1975-94.

Numbers of spring chinook salmon that entered the hatchery in 1981-94 compared reasonably well with estimates of the number of hatchery fish that survived after the fishery and prespawning mortality. Estimation errors were greatest for jacks that returned in the late 1980s (Table 32). Estimation errors were less for adults and the total number of spring chinook salmon



Table 32. Estimated number of hatchery spring chinook salmon alive upstream of Gold Ray Dam after harvest and prespawning mortality as compared to the actual number that entered Cole M. Rivers Hatchery, 1981-94. Fish that entered the hatchery after 10 October were assumed to be fall chinook salmon. A large portion of fish that entered the hatchery before 1981 were of wild origin.

	Jacks		Adults		Total	
	Estimated	Hatchery	Estimated	Hatchery	Estimated	Hatchery
1981	603	545	1,495	1,676	2,098	2,221
1982	2,425	2,095	4,172	3,646	6,597	5,741
1983	1,415	1,273	1,513	1,864	2,928	3,137
1984	1,823	3,265	2,159	1,919	3,982	5,184
1985	4,633	5,356	4,514	7,917	9,147	13,273
1986	13,549	5,849	25,965	30,383	39,514	36,232
1987	7,152	3,391	31,651	20,769	38,803	24,160
1988	7,054	4,238	15,586	20,284	22,640	24,522
1989	4,272	1,000	31,987	30,859	36,259	31,859
1990	1,464	469	9,759	4,646	11,223	5,115
1991	1,187	318	5,765	3,998	6,951	4,316
1992	315	776	1,174	1,596	1,489	2,372
1993	4,098	3,072	10,473	9,891	14,572	12,963
1994	1,303	680	3,972	3,725	5,275	4,405

(Table 32). These findings suggested that estimates of (1) passage at Gold Ray Dam, (2) harvest, and (3) prespawning mortality resulted in reasonable estimates of the abundance of adult spring chinook salmon of hatchery origin.

### Abundance at Spawning

Spawning escapement of chinook salmon in the area upstream of Gold Ray Dam varied greatly during 1974-94. Annual estimates of the number of jacks that spawned averaged 9,295 fish and ranged between 1,476 and 31,205 fish. Annual estimates of the number of adult males that spawned averaged 7,317 fish and ranged between 2,413 and 18,852 fish. Annual estimates of the number of adult females that spawned averaged 8,484 fish and ranged between 2,721 and 20,403 fish. Estimates of spawning escapement are in Appendix Table E-16.

We found that estimates of the number of chinook salmon that spawned upstream of Gold Ray Dam were significantly related to the number of carcasses that were recovered during spawning surveys. Carcass counts accounted for 87% of the variation in the annual estimates of the number of female spawners (Figure 26), 88% of the variation in the annual estimates of the number of adult male spawners, and 45% of the variation in the annual estimates of the number of jacks that spawned. These findings suggested that our estimates of spawner numbers were, at least, reasonable indexes of annual spawning escapement in the area upstream of Gold Ray Dam. Data included in these analyses are in Appendix Tables E-16 and E-17.

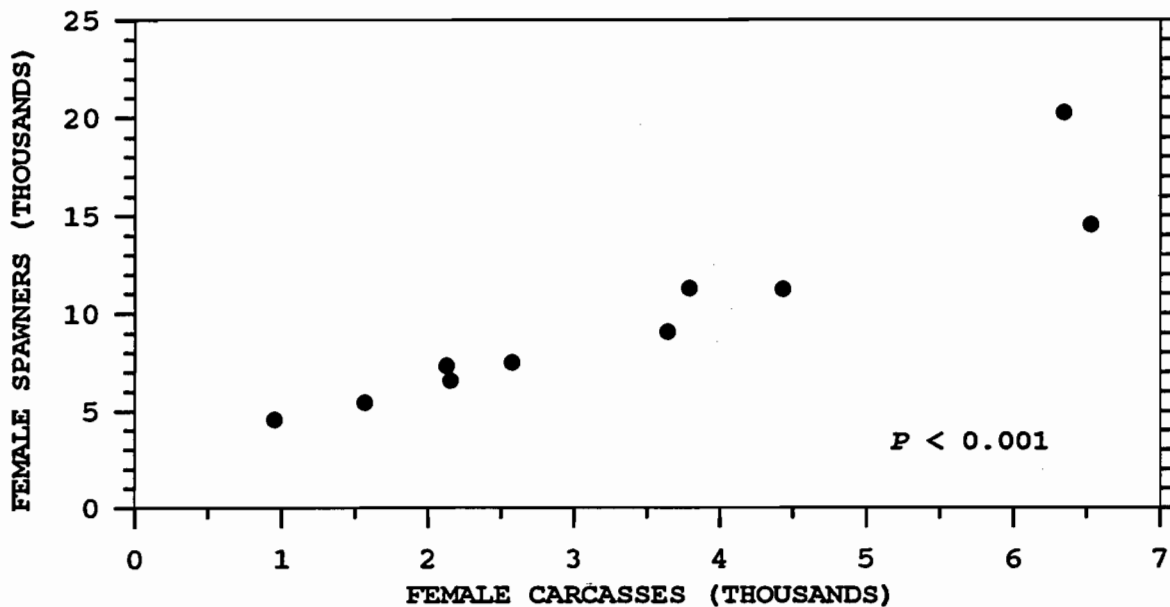

Figure 26. Relationship between the estimated number of female chinook salmon that spawned upstream of Gold Ray Dam and the number of female chinook salmon recovered as spawned carcasses, 1974-81 and 1986-87.

Other studies have also reported positive correlations between carcass counts and estimates of spawning escapement. For example, Jonasson and Lindsay (1988) reported a positive correlation between carcass counts and the spawning escapement of fall chinook salmon in the Deschutes River of Oregon.

We estimated that carcass surveyors found an average of 12% of the jack chinook salmon, and 33% of the adult chinook salmon, estimated to have spawned upstream of Gold Ray Dam in 1974-81 and in 1986-87. Assuming no differential bias in estimation of spawning escapement, surveyors found a greater proportion of the adults that spawned as compared to jacks that spawned (t for paired t-test of arcsin transformed data = 5.58,  $P < 0.001$ ). Differential rates of recovery for salmonid carcasses of differing sizes have also been documented (Bjornn 1978; Solazzi 1984; Boecheler and Jacobs 1987). Data included in the analyses are in Appendix Tables E-16 and E-17.

Reservoir management strategies affected the spawning escapement of spring chinook salmon and fall chinook salmon in the upper river because the dam blocked a portion of the spawning habitat and changes in water quality and quantity affected fish production (see **Abundance**, page 67 and **Abundance in the Ocean**, page 106), age at maturity (see **Maturity Rates**, page 138), rates of prespawning mortality (see **Prespawning Mortality**, page 162), and rates of freshwater harvest (see **Harvest Rate**, page 196).

### Abundance at River Entry

Estimates of the number of age 2-6 wild and hatchery spring chinook salmon that returned to the Rogue River in 1974-94 are in Appendix Table E-18. Estimates of the number of age 2-6 wild and hatchery fall chinook salmon that returned to the Rogue River in 1974-94 are in Appendix Table E-19. Estimated

numbers of fall chinook salmon represent only those fish that would have migrated and spawned upstream of Gold Ray Dam.

We also estimated the number of chinook salmon that would have returned to the Rogue River if there had been no fishing related mortality in the ocean and if there had been no increase in the natural mortality of age 2-5 fish during the El Niño event of 1982-83 (Appendix Tables E-20 through E-23). These estimates were used to reduce the bias of age-selective mortality on the estimates of abundance and life history parameters (see Juveniles, page 23).

### Estimation of Ocean Harvest Rates

We completed cohort assessments for 182 groups of Ad-CWT marked spring chinook salmon released from Cole M. Rivers Hatchery in 1976-90. Numbers of fish that returned to the hatchery and estimates of the number landed in the ocean fisheries are in Appendix Table E-24. Rates of prespawning mortality and freshwater harvest used in the cohort assessments are in Appendix Table E-25. Resultant estimates of fish numbers in the ocean prior to harvest, and estimates of the annual rates of ocean harvest, are in Appendix Table E-26.

Because the El Niño event of 1982-83 likely increased the mortality rates of chinook salmon resident in the ocean (ODFW 1992), we plotted the estimated freshwater return at age  $i$  with the estimated ocean abundance of cohorts at age  $i+1$  for Ad-CWT marked groups released in September and October. We used data only from those groups because date of release affects maturation rates and fishery contribution rates (Hankin 1990), and October was the only month with consistent releases of Ad-CWT marked fish.

We found that the ocean abundance of age 6 fish and age 5 fish in 1983 did not appear to be unusually low given the numbers of cohorts that returned to the Rogue River in 1982 (Figure 27 and Figure 28). Consequently, we

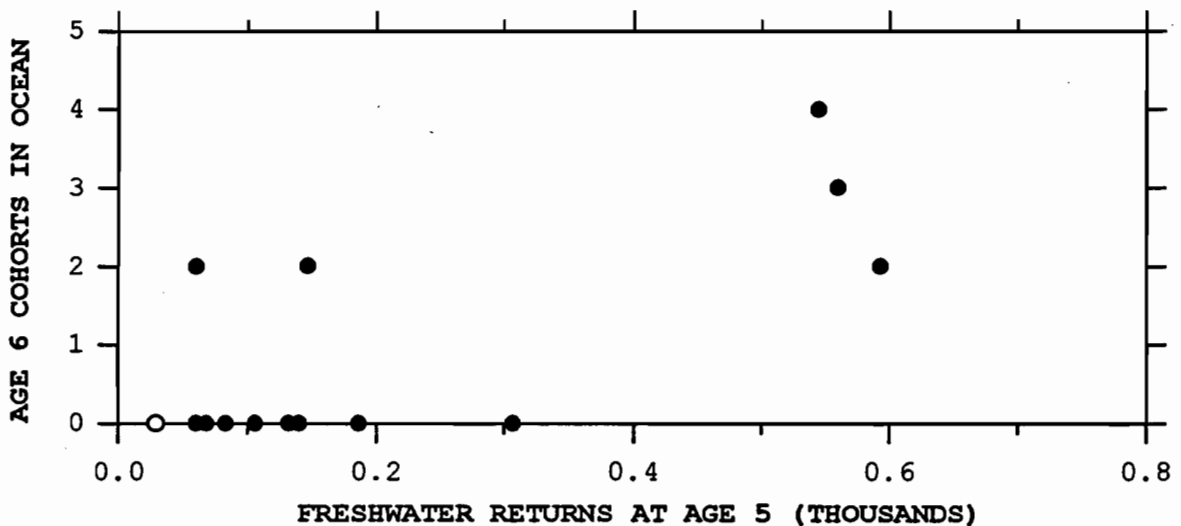

Figure 27. Number of age 6 Ad-CWT marked spring chinook salmon in the ocean during spring as compared to the freshwater return of age 5 cohorts one year earlier. Pooled estimates include only fish released in September-October. Open circle represents the brood year exposed to the El Niño event of 1982-83.

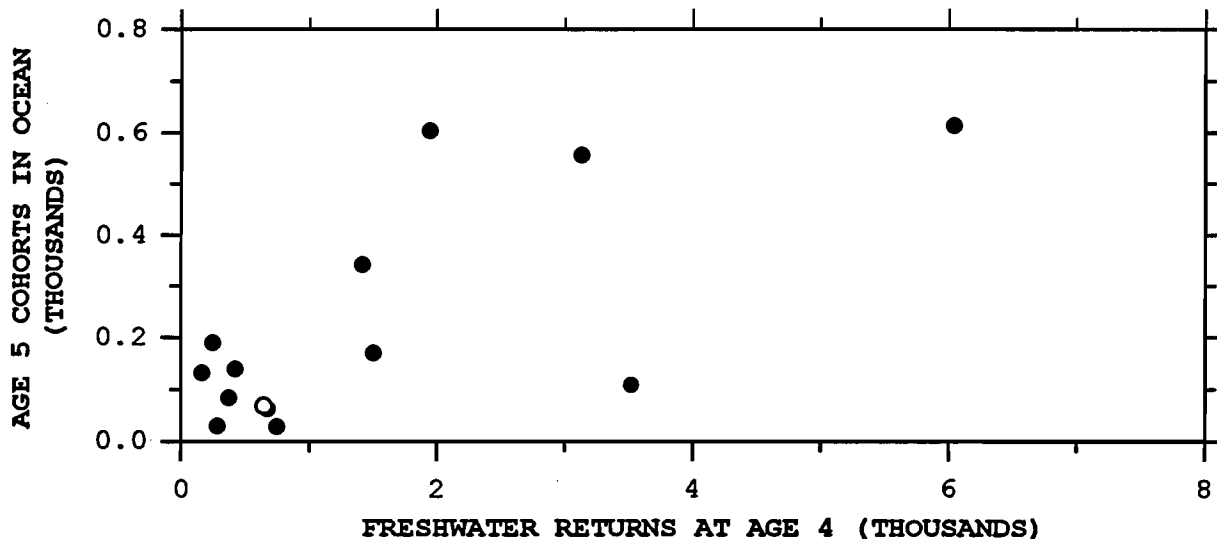

Figure 28. Number of age 5 Ad-CWT marked spring chinook salmon in the ocean during spring as compared to the freshwater return of age 4 cohorts one year earlier. Pooled estimates include only fish released in September-October. Open circle represents the brood year exposed to the El Niño event of 1982-83.

assumed that the El Niño event of 1982-83 did not affect the survival rates of age 4 or age 5 fish during winter. Data included in the plots are in Appendix Table E-27. Conversely, the El Niño event of 1982-83 appeared to increase the overwinter mortality rates of younger fish.

We found that estimates of the ocean abundance of age 4 Ad-CWT marked fish were significantly related to freshwater returns of age 3 cohorts ( $r = 0.93$ ,  $P < 0.001$  for data transformed to natural logarithms). Data from the 1979 brood year was excluded from the analysis because those fish were resident in the ocean during the El Niño event of 1982-83. The ocean abundance of age 4 fish from the 1979 brood year appeared to be unusually low based on the number of age 3 fish that returned to the Rogue River in 1982 (Figure 29).

We predicted that 2,569 (95% CI = 882-7,483) age 4 Ad-CWT fish from the 1979 brood year should have been resident in the ocean in spring of 1983 from a regression of the ocean abundance of age 4 Ad-CWT fish on freshwater returns of age 3 cohorts. The observed number of fish (1,091) was 42% of the predicted number of fish (2,569). We assumed that the El Niño event of 1982-83 was responsible for an increase in the natural mortality rate and changed the assumed winter survival rate of 0.8 to 0.34 ( $0.8 \times 0.42$ ) for age 3-4 fish from the 1979 brood year to better estimate the number, and harvest rate, of age 3 fish resident in the ocean during 1982. Data included in the regression analysis are in Appendix Table E-27.

We also found that estimates of the ocean abundance of age 3 Ad-CWT marked fish were significantly related to freshwater returns of age 2 cohorts ( $r = 0.92$ ,  $P < 0.001$  for data transformed to natural logarithms). Data from the 1980 brood year was excluded from the analysis because those fish were resident in the ocean during the El Niño event of 1982-83. The ocean abundance of age 3 fish from the 1980 brood year appeared to be unusually low based on the number of age 2 fish that returned to the Rogue River in 1982 (Figure 30).

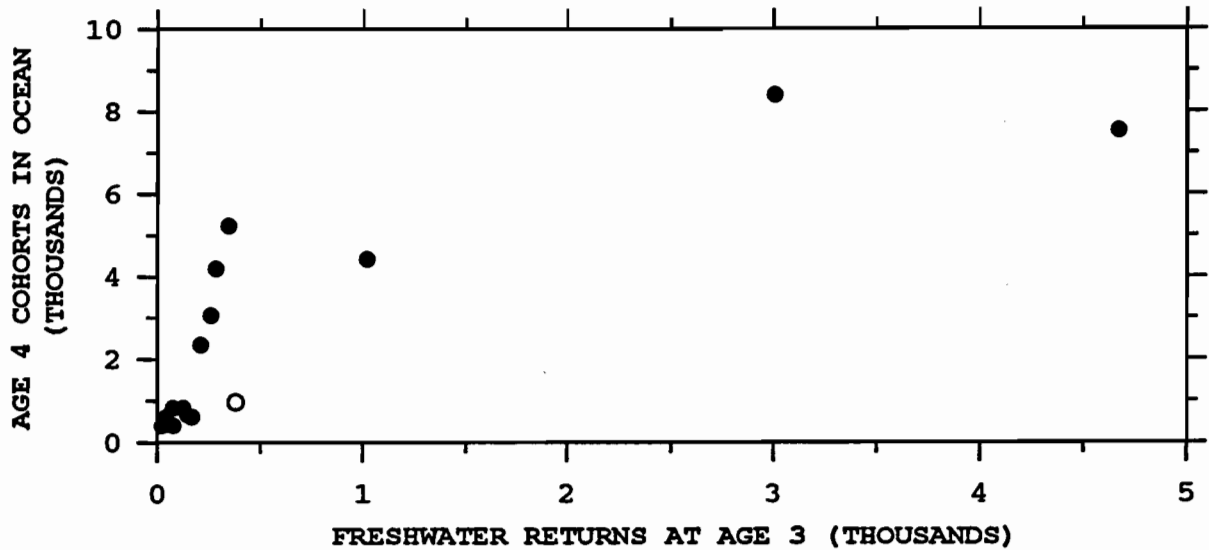

Figure 29. Number of age 4 Ad-CWT marked spring chinook salmon in the ocean during spring as compared to the freshwater return of age 3 cohorts one year earlier. Pooled estimates include only fish released in September-October. Open circle represents the brood year exposed to the El Niño event of 1982-83.

We predicted that 8,450 (95% CI = 2,904-24,586) age 3 Ad-CWT fish from the 1980 brood year should have been resident in the ocean in spring of 1983 from a regression of the ocean abundance of age 3 Ad-CWT fish on freshwater returns of age 2 cohorts. The observed number of fish (1,105) was 13% of the predicted number of fish (8,450). We assumed that the El Niño event of 1982-83 was responsible for an increase in natural mortality and changed the assumed winter survival rate of 0.5 to 0.07 ( $0.5 \times 0.13$ ) for age 2-3 fish from the 1980 brood year to better estimate the number of age 2 resident in the ocean during 1982. Data included in the regression analysis are in Appendix Table E-27.

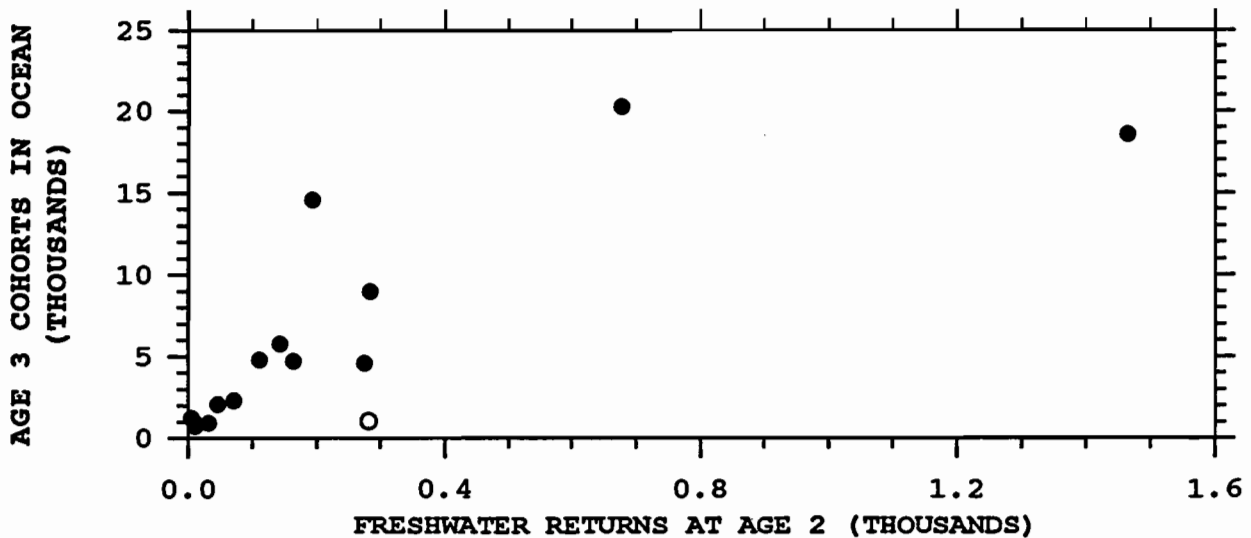

Figure 30. Number of age 3 Ad-CWT marked spring chinook salmon in the ocean during spring as compared to the freshwater return of age 2 cohorts one year earlier. Pooled estimates include only fish released in September-October. Open circle represents the brood year exposed to the El Niño event of 1982-83.

Hankin (1990) found that ocean harvest rates differed for age 3 fall chinook salmon that originated from October and April releases at hatcheries in the Klamath River Basin. We found that, in some years, Ad-CWT marked groups of spring chinook salmon released in August-October also were harvested at significantly different rates as age 3 fish in the ocean (Table 33). Results indicated that fish released in August were harvested at greater rates in the ocean fisheries, at age 3, as compared to fish released in September or October. In contrast, we were unable to detect any differences in harvest rates at age 3 between groups released in September and October (Table 33).

Our findings, and those of Hankin (1990), indicated that release date affected ocean harvest rates of hatchery fish at age 3. Consequently, we chose to use only those harvest rate estimates calculated from tag groups released in September and October. While fish released from the hatchery in September-October appear to enter the ocean later as compared to wild fish (see Time of Migration, page 88), hatchery fish are larger than wild fish at time of ocean entry. In addition, consistent releases of Ad-CWT marked fish in August did not begin at Cole M. Rivers Hatchery until 1985 while Ad-CWT marked fish have been released in September or October since 1976.

There were 79 tag groups from the 1975-90 brood years that met the minimum criterion of 50 fish alive in the ocean at age 4 to estimate ocean harvest rates of age 4 fish. There were 110 tag groups that met the minimum criterion of 200 fish alive in the ocean at age 3 to estimate ocean harvest rates of age 3 fish.

We estimated that ocean harvest rates of Ad-CWT marked spring chinook salmon released from Cole M. Rivers Hatchery annually ranged between 0.03 and 0.54 for age 3 fish and ranged between 0.03 and 0.75 for age 4 fish for the 1975-90 brood years (Table 34). Harvest rate estimates for spring chinook salmon that originated from the Rogue River generally were similar to those estimated for fall chinook salmon that originated from the Klamath River Basin in northern California (Table 34). Differences in harvest rate estimates were most evident for age 3 fish harvested in 1983-84, and for age 4 fish harvested in 1988-94 (Table 34).

Table 33. Comparisons of ocean harvest rates estimated for age 3 Ad-CWT marked spring chinook salmon released in August-October at Cole M. Rivers Hatchery, 1984-86 brood years. Analysis of variance tests included only those release groups with at least 200 age 3 fish estimated to be alive in the ocean prior to harvest. Data were arcsin transformed prior to analysis. Within rows, means with different superscripts differed at  $P \leq 0.05$  based on a Newman-Keuls Multiple Range Test.

Brood year	Month of release			P for difference
	August	September	October	
1984	0.495 <sup>a</sup>	0.315 <sup>b</sup>	0.287 <sup>b</sup>	<0.001
1985	0.373 <sup>a</sup>	0.283 <sup>b</sup>	0.313 <sup>ab</sup>	0.005
1986	0.639 <sup>a</sup>	0.553 <sup>a</sup>	0.512 <sup>a</sup>	0.145

Table 34. Ocean harvest rates estimated for Ad-CWT marked groups of spring chinook salmon released from Cole M. Rivers Hatchery as compared to ocean harvest rates estimated for fall chinook salmon of Klamath River Basin origin, 1978-94. Harvest rates for spring chinook salmon were estimated only from groups released in September-October. Harvest rates for fall chinook salmon were received from Steven Jacobs, ODFW, Corvallis.

Fishery year	Spring chinook salmon						Fall chinook salmon	
	Age 3 fish			Age 4 fish			Age 3	Age 4
	Mean	N	SD	Mean	N	SD		
1978	0.13 <sup>a</sup>	2	0.07	--	0	--	--	--
1979	0.50 <sup>a</sup>	3	0.06	0.69 <sup>a</sup>	5	0.06	0.36	0.68
1980	0.34 <sup>a</sup>	2	0.04	0.80 <sup>a</sup>	6	0.08	0.43	0.75
1981	0.42 <sup>a</sup>	5	0.08	0.74 <sup>a</sup>	6	0.13	0.42	0.66
1982	0.50 <sup>a</sup>	5	0.06	0.54 <sup>a</sup>	6	0.07	0.60	0.65
1983	0.12 <sup>a</sup>	3	0.01	0.63 <sup>a</sup>	6	0.13	0.30	0.70
1984	0.03 <sup>a</sup>	10	0.01	0.27 <sup>a</sup>	5	0.08	0.15	0.43
1985	0.30 <sup>a</sup>	12	0.03	0.36 <sup>a</sup>	10	0.17	0.27	0.29
1986	0.36 <sup>a</sup>	12	0.05	0.60 <sup>a</sup>	1	--	0.32	0.52
1987	0.30 <sup>a</sup>	14	0.06	0.64 <sup>a</sup>	12	0.07	0.38	0.53
1988	0.29	15	0.04	0.75	10	0.11	0.39 <sup>a</sup>	0.45 <sup>a</sup>
1989	0.54	1	--	0.82	10	0.11	0.22 <sup>a</sup>	0.44 <sup>a</sup>
1990	0.24	1	--	0.61	1	--	0.65 <sup>a</sup>	0.61 <sup>a</sup>
1991	0.20	1	--	0.31	1	--	0.17 <sup>a</sup>	0.21 <sup>a</sup>
1992	0.09	1	--	0.06	1	--	0.03 <sup>a</sup>	0.04 <sup>a</sup>
1993	0.09	1	--	0.51	1	--	0.12 <sup>a</sup>	0.11 <sup>a</sup>
1994	--	--	--	0.18	1	--	0.06 <sup>a</sup>	0.07 <sup>a</sup>

<sup>a</sup> Estimates used in analyses within this report.

We believe that the differences in estimates of harvest rates for the age 3 fish in 1983-84 likely resulted from our adjustment of survival rates in winter during the El Niño event of 1982-83 (see *Effects of the El Niño Event of 1982-83*: page 125). We also believe that the differences in estimates of harvest rates for age 4 fish in 1988-94 likely resulted from the small numbers of age 5 Ad-CWT marked spring chinook salmon that returned to freshwater in 1989-95 (estimated to range between 30 and 154 fish annually for pooled tag groups). Consequently, we decided to use estimates of ocean harvest rates of fall chinook salmon from the Klamath River Basin to represent ocean harvest rates of wild age 4 spring chinook salmon of Rogue River origin for the 1988-94 fishery years.

#### Abundance in the Ocean

Estimates of the ocean abundance of chinook salmon that originated from the Rogue River upstream of Gold Ray Dam were developed by reconstruction of cohort numbers. Assessments of the effects of the El Niño event of 1982-83 on the

ocean abundance of wild chinook salmon were limited to fish from the 1977-84 brood years because we found these brood years matured at different rates as compared to other brood years (see Maturity Rates, page 138).

**Wild Spring Chinook Salmon:** Estimates of the number of wild age 6 fish resident in the ocean during spring of 1974-94 averaged 143 fish and ranged between 0 and 695 fish. Numbers of age 6 fish averaged 215 fish from the 1968-76 brood years and 89 fish from the 1977-88 brood years. We found that the median number of age 6 fish in the ocean before and after reservoir operation differed significantly (Mann-Whitney U = 130.0, P = 0.030). Data included in the analysis are presented in Appendix Table E-18 as freshwater returns because all age 6 fish matured and returned to freshwater.

Estimates of the number of wild age 6 fish resident in the ocean were significantly related to freshwater returns of age 5 cohorts for the 1978-84 brood years ( $r = 0.76$ ,  $P = 0.050$ ). Because the ocean abundance of age 6 fish from the 1977 brood year did not appear to be unusually low based on the number of age 5 fish that returned to the Rogue River in 1982 (Figure 31), we assumed that the El Niño event of 1982-83 did not significantly change the survival rates of age 5 fish during the winter. Data included in the analysis are in Appendix Tables E-18 and E-28.

Estimates of the number of wild age 5 fish resident in the ocean during spring of 1974-94 averaged 4,444 fish and ranged between 397 and 9,141 fish. Numbers of age 5 fish averaged 7,225 fish from the 1969-76 brood years and 2,589 fish from the 1977-88 brood years. We found that the median number of age 5 fish in the ocean before and after reservoir operation differed

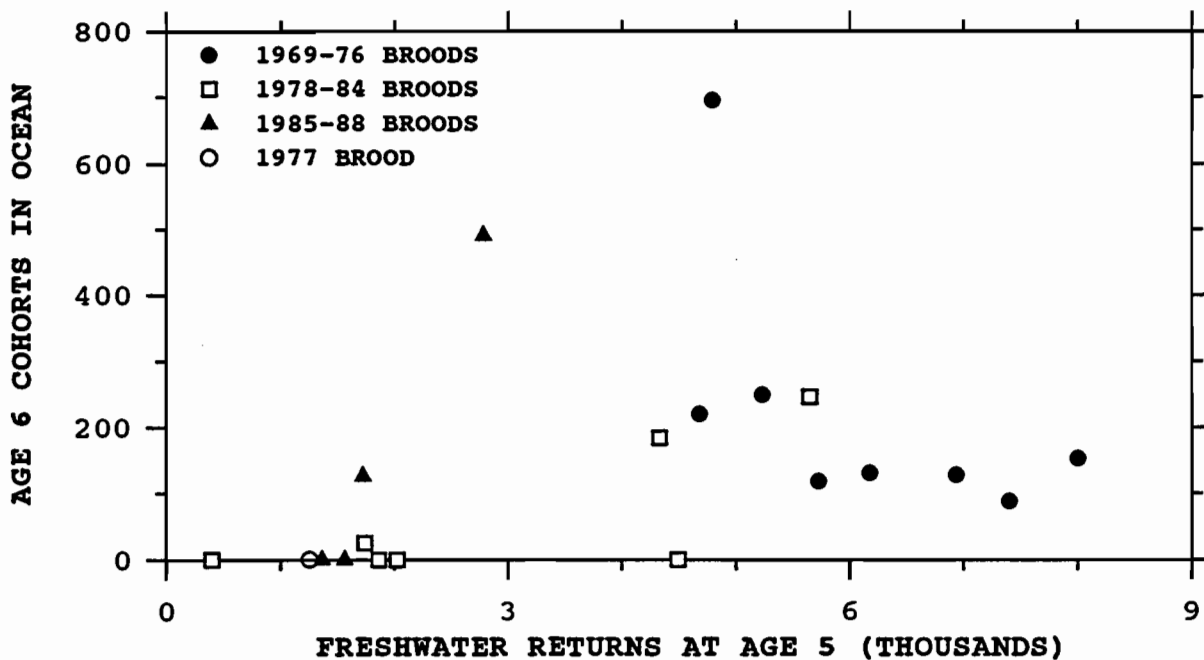

Figure 31. Estimated number of wild age 6 spring chinook salmon in the ocean during spring as compared to the estimated freshwater return of age 5 cohorts one year earlier, 1969-88 brood years. Open circle represents the brood year exposed to the El Niño event of 1982-83.



significantly (Mann-Whitney  $U = 131.0$ ,  $P < 0.001$ ). Data included in the analysis are in Appendix Table E-28.

Estimates of the number of wild age 5 fish resident in the ocean were significantly related to freshwater returns of age 4 cohorts for the 1977-84 brood years ( $r = 0.84$ ,  $P = 0.027$  for data transformed to natural logarithms). Data from the 1978 brood year were excluded from the analysis because those fish were resident in the ocean during the El Niño event of 1982-83 and data from the 1980 brood year was excluded as an outlier. Because the ocean abundance of age 5 fish from the 1978 brood year did not appear to be unusually low based on the number of age 4 fish that returned to the Rogue River in 1982 (Figure 32), we assumed that the El Niño event of 1982-83 did not significantly change the survival rates of age 4 fish during the winter. Data included in the analysis are in Appendix Tables E-18 and E-28.

Estimates of the number of wild age 4 fish resident in the ocean during spring of 1974-94 averaged 27,270 fish and ranged between 5,366 and 56,098 fish. Numbers of age 4 fish averaged 45,444 fish from the 1970-76 brood years and 17,484 fish from the 1977-89 brood years. We found that the median number of age 4 fish in the ocean before and after reservoir operation differed significantly (Mann-Whitney  $U = 112.0$ ,  $P = 0.003$ ). Data included in the analysis are in Appendix Table E-28.

Estimates of the number of wild age 4 fish resident in the ocean were significantly related to freshwater returns of age 3 cohorts for the 1977-84 brood years ( $r = 0.92$ ,  $P = 0.004$  for data transformed to natural logarithms). Data from the 1979 brood year were excluded from the analysis

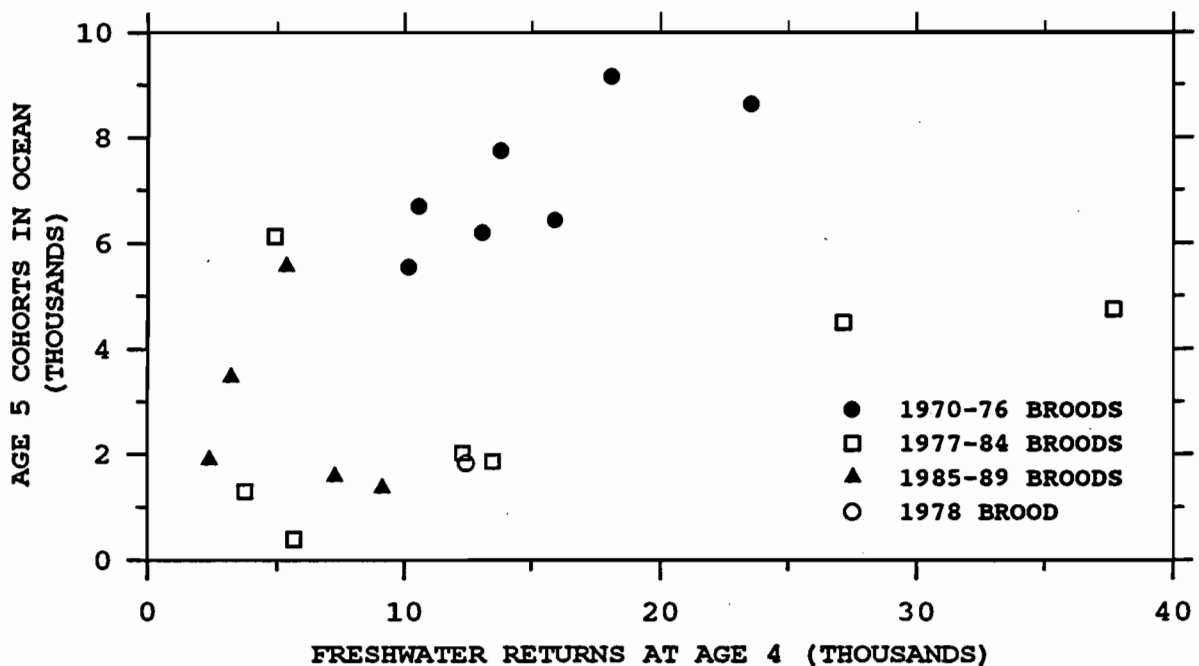

Figure 32. Estimated number of wild age 5 spring chinook salmon in the ocean during spring as compared to the estimated freshwater return of age 4 cohorts one year earlier, 1970-89 brood years. Open circle represents the brood year exposed to the El Niño event of 1982-83.

because those fish were resident in the ocean during the El Niño event of 1982-83. The ocean abundance of age 4 fish from the 1979 brood year appeared to be unusually low based on the number of age 3 fish that returned to the Rogue River in 1982 (Figure 33).

We predicted that 21,440 (95% CI = 12,103-37,979) wild age 4 fish from the 1979 brood year should have been resident in the ocean in spring of 1983 from a regression of the ocean abundance of age 4 fish on freshwater returns of age 3 cohorts for the 1977-84 brood years. The observed number of fish (7,011) was 33% of the predicted number of fish (21,440). We assumed that the El Niño event of 1982-83 was responsible for an increase in the natural mortality rate and changed the assumed winter survival rate of 0.8 to 0.26 ( $0.8 \times 0.33$ ) for age 3-4 fish from the 1979 brood year to better estimate the number of age 3 resident in the ocean during 1982. Data included in the regression analysis are in Appendix Tables E-18 and E-28.

Estimates of the number of wild age 3 fish resident in the ocean during spring of 1974-94 averaged 60,754 fish and ranged between 9,873 and 151,344 fish. Numbers of age 3 fish averaged 104,520 fish from the 1971-76 brood years and 40,554 fish from the 1977-89 brood years. We found that the mean number of age 3 fish in the ocean before and after reservoir operation differed significantly ( $F = 17.60$ ,  $P = 0.001$ ). Data included in the analysis are in Appendix Table E-28.

Estimates of the number of wild age 3 fish resident in the ocean were significantly related to freshwater returns of age 2 cohorts for the 1977-84 brood years ( $r = 0.74$ ,  $P = 0.057$  for data transformed to natural

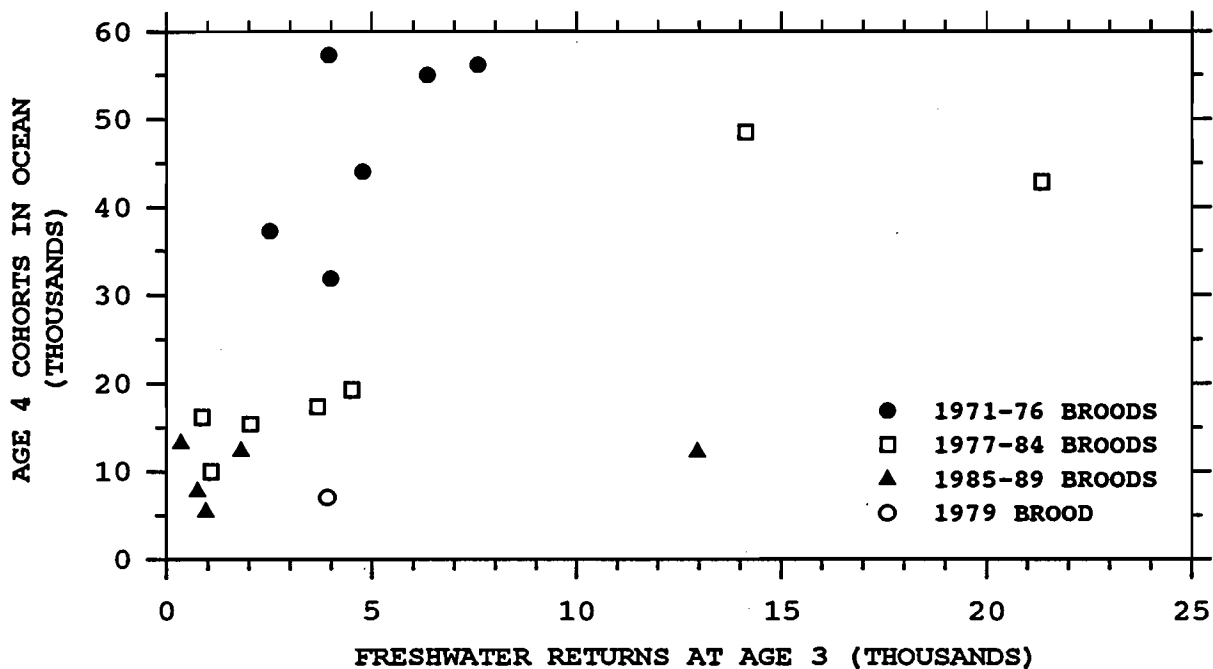

Figure 33. Estimated number of wild age 4 spring chinook salmon in the ocean during spring as compared to the estimated freshwater return of age 3 cohorts one year earlier, 1971-89 brood years. Open circle represents the brood year exposed to the El Niño event of 1982-83.

logarithms). Data from the 1980 brood year were excluded from the analysis because those fish were resident in the ocean during the El Niño event of 1982-83. The ocean abundance of age 3 fish from the 1980 brood year appeared to be unusually low based on the number of age 2 fish that returned to the Rogue River in 1982 (Figure 34).

We predicted that 69,042 (95% CI = 18,086-263,555) wild age 3 fish from the 1980 brood year should have been resident in the ocean in spring of 1983 from a regression of the ocean abundance of age 3 fish on freshwater returns of age 2 cohorts for the 1977-84 brood years. The observed number of fish (24,064) was 35% of the predicted number of fish (69,042). We assumed that the El Niño event of 1982-83 was responsible for an increase in the natural mortality rate and changed the assumed winter survival rate of 0.5 to 0.17 ( $0.5 \times 0.35$ ) for age 2-3 fish from the 1980 brood year to better estimate the number of age 3 resident in the ocean during 1982. Data included in the regression analysis are in Appendix Tables E-18 and E-28.

Estimates of the number of wild age 2 fish resident in the ocean during spring of 1974-94 averaged 136,511 fish and ranged between 21,388 and 331,218 fish. Numbers of age 2 fish averaged 241,043 fish from the 1972-76 brood years and 96,308 fish from the 1977-89 brood years. We found that the mean number of age 2 fish in the ocean before and after reservoir operation differed significantly ( $F = 16.62, P = 0.001$ ). Data included in the analysis are in Appendix Table E-28.

We hypothesized that numbers of age 2 fish were primarily affected by (1) juvenile abundance, (2) rate of freshwater growth and size at ocean entry,

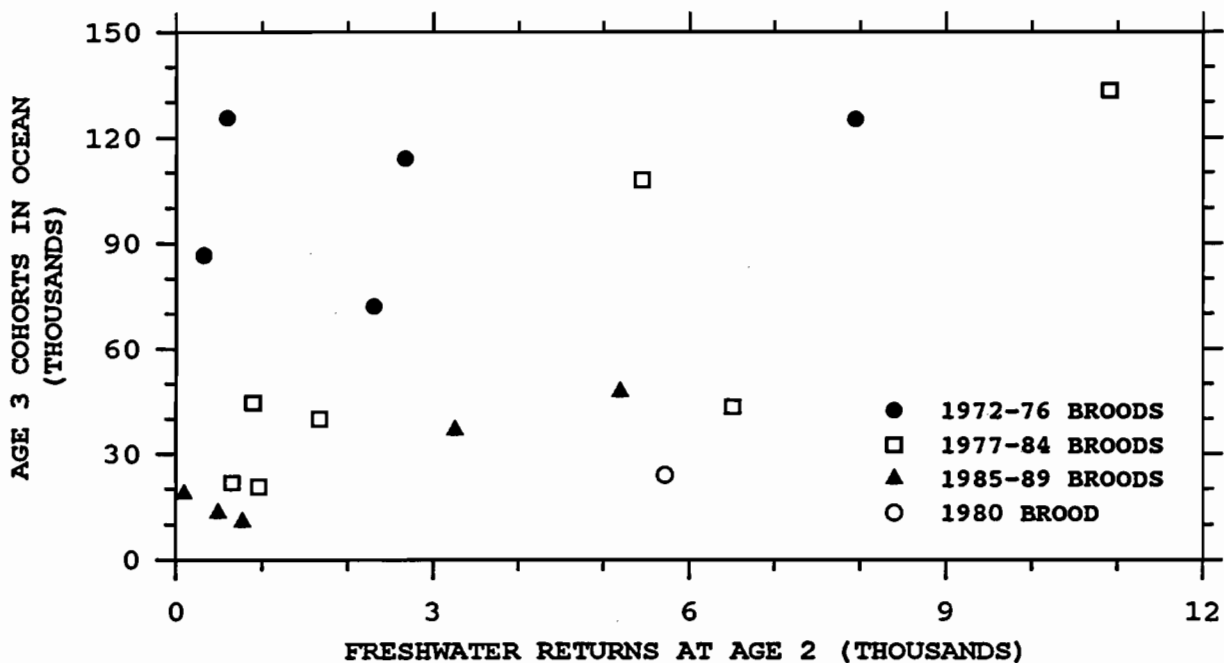

Figure 34. Estimated number of wild age 3 spring chinook salmon in the ocean during spring as compared to the estimated freshwater return of age 2 cohorts one year earlier, 1972-89 brood years. Open circle represents the brood year exposed to the El Niño event of 1982-83.

(3) river flow and water temperature during summer, and (4) ocean physical parameters during the period when smolts entered the ocean. The two indexes of juvenile abundance were highly correlated (see Abundance, page 67), so we only included estimates of the number of subyearlings that passed Savage Rapids Dam as an independent variable.

We were unable to identify the primary factors that affected the number of wild age 2 fish from the 1974-89 brood years. Regression analysis indicated that numbers of age 2 fish were negatively related to the number of juvenile migrants and were positively related to water temperature of the river in summer. However, these relationships do not seem plausible because recruitment should be positively related to juvenile production and also should be negatively related to river temperature. Data included in the analysis are in Appendix Table E-29. A correlation matrix that outlines relationships between variables included in the regression analysis is in Appendix Table E-30.

We plotted estimates of the number of wild age 2 fish resident in the ocean on estimates of the number of cohorts that migrated as subyearlings and found that numbers of age 2 fish from the 1974-84 brood years appeared to be positively related to estimates of juvenile production (Figure 35). In contrast, data from the 1985-89 brood years did not fit the relationship (Figure 35). This finding suggested that there was a marked decrease in the survival rates of juvenile fish during the late 1980s as compared to earlier years. As a result, we again analyzed factors that may have affected the number of age 2 fish, but limited the analysis to data from only the 1974-84 brood years.

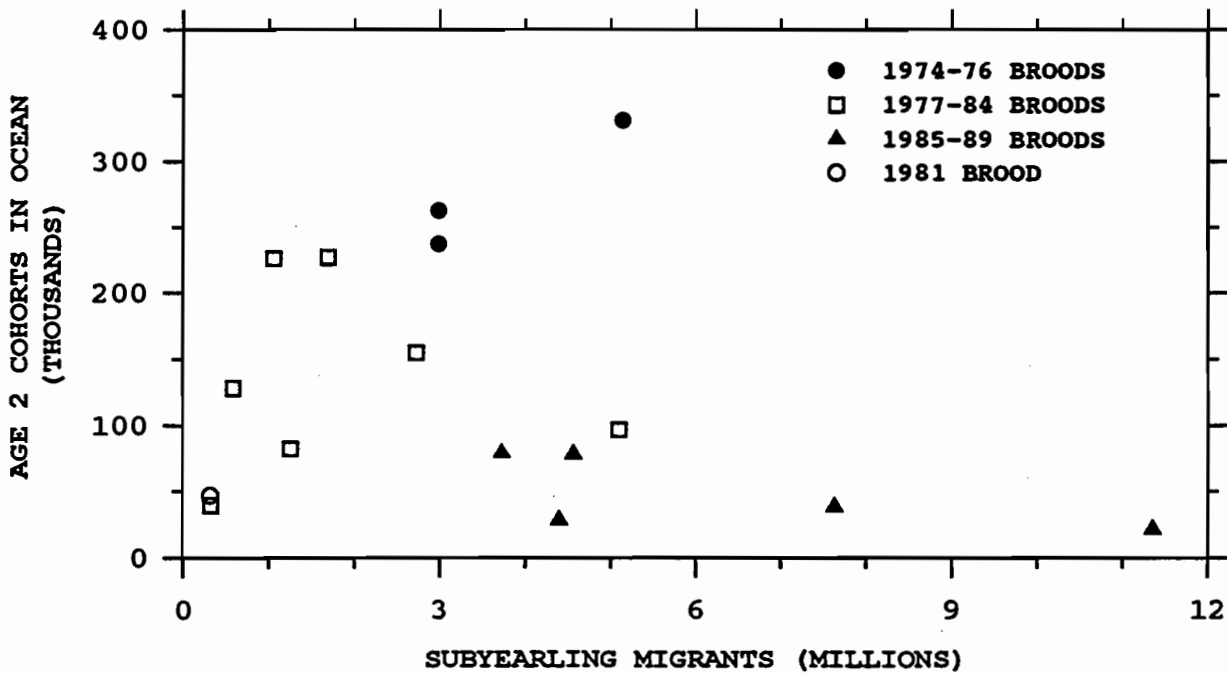

Figure 35. Estimated number of wild age 2 spring chinook salmon in the ocean during spring as compared to the estimated number of subyearlings that passed Savage Rapids Dam one year earlier, 1974-89 brood years. Open circle represents the brood year exposed to the El Niño event of 1982-83.

We found that numbers of age 2 fish from the 1974-84 broods were significantly related to numbers of subyearling migrants. Numbers of age 2 recruits increased as the number of juveniles increased. A regression analysis (Appendix Table E-31) suggested that an additional 63,000 age 2 fish were produced for every million migrants that passed Savage Rapids Dam during late spring and summer. Annual estimates of subyearling migrants produced by the 1974-84 brood years ranged between 300,000 and 5,000,000 fish.

Residual variation from the relationship between juvenile abundance and age 2 recruits was negatively related to ocean temperature during summer, as indexed at Charleston, Oregon. Numbers of age 2 recruits increased as the water temperature decreased. The regression analysis (Appendix Table E-31) suggested that an additional 102,000 age 2 fish were produced for every 1°C decrease in mean ocean temperature during summer. Mean water temperatures in summer at Charleston ranged between 11.6°C and 14.2°C in 1975-85.

Residual variation from the second step in the regression was positively related to estimates of smolt lengths at the time of ocean entry. Numbers of age 2 recruits increased as smolts entered the ocean at a larger size. The regression analysis (Appendix Table E-31) suggested that an additional 98,000 age 2 fish were produced for every one centimeter increase in the mean length of smolts. We estimated that mean smolt lengths ranged between 10.2 and 11.7 cm for the 1974-84 brood years. These estimates apply only to those fish that survived to age 2 because we used scales from adults to estimate smolt lengths.

Results of the multiple regression must be interpreted with caution. Inclusion of 3 independent variables is excessive for a regression analysis with only 11 years of data. Also, the analysis failed to account for the low numbers of age 2 fish produced by the 1985-89 brood years. However, we have some confidence in the results because the effects of each independent variable on salmonid production is documented in the literature, and the independent variables in the regression were not intercorrelated. A correlation matrix that outlines the relationships among all variables examined the regression analysis of the 1974-84 brood years is in Appendix Table E-32.

**Spring Chinook Salmon of Hatchery Origin:** We separately estimated the ocean abundance of hatchery fish that were reared to compensate for spawning habitat blocked by Lost Creek Dam (August-March releases) as compared to the ocean abundance of hatchery fish reared to supplement the fisheries (June releases). The following results apply only to mitigation releases.

Estimates of the number of age 6 hatchery fish resident in the ocean during spring of 1974-94 averaged 38 fish and ranged between 0 and 232 fish. Numbers of age 6 fish averaged 34 fish from the 1968-76 brood years and 40 fish from the 1977-88 brood years. Data included in the analysis are presented in Appendix Table E-18 as freshwater returns because all age 6 fish in the ocean matured and returned to freshwater.

Estimates of the number of age 6 hatchery fish resident in the ocean were not significantly related to freshwater returns of age 5 cohorts for the 1969-88 brood years ( $r = 0.32$ ,  $P = 0.197$  for data transformed to natural logarithms). Because the ocean abundance of age 6 fish from the 1977 brood year did not appear to be unusually low based on the number of age 5 fish that returned to the Rogue River in 1982 (Figure 36), we assumed that the El Niño

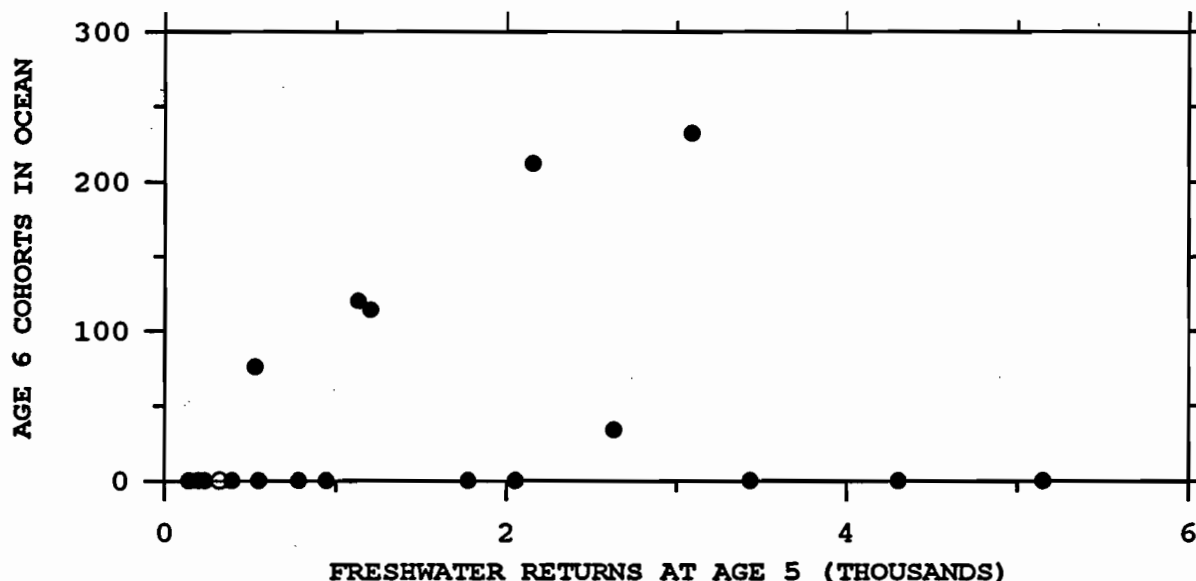

Figure 36. Estimated number of age 6 spring chinook salmon of hatchery origin in the ocean during spring as compared to the estimated freshwater return of age 5 cohorts one year earlier, 1969-88 brood years. Estimates include only those smolts released after 1 August. Open circle represents the brood year exposed to the El Niño event of 1982-83.

event of 1982-83 did not significantly change the survival rates of age 5 fish during the winter. Data included in the analysis are in Appendix Tables E-18 and E-33.

Estimates of the number of age 5 hatchery fish resident in the ocean during spring of 1974-94 averaged 1,682 fish and ranged between 144 and 5,152 fish. Numbers of age 5 fish averaged 890 fish from the 1969-76 brood years and 2,211 fish from the 1977-88 brood years.

Estimates of the number of age 5 hatchery fish resident in the ocean were significantly related to freshwater returns of age 4 cohorts for the 1970-88 brood years ( $r = 0.82$ ,  $P < 0.001$  for data transformed to natural logarithms). Because the ocean abundance of age 5 fish from the 1978 brood year did not appear to be unusually low based on the number of age 4 fish that returned to the Rogue River in 1982 (Figure 37), we assumed that the El Niño event of 1982-83 did not significantly change the survival rates of age 4 fish during the winter. Data included in the analysis are in Appendix Table E-33.

Estimates of the number of age 4 hatchery fish resident in the ocean during spring of 1974-94 averaged 14,704 fish and ranged between 868 and 52,784 fish. Numbers of age 4 fish averaged 7,122 fish from the 1970-76 brood years and 18,787 fish from the 1977-89 brood years.

Estimates of the number of age 4 hatchery fish resident in the ocean were significantly related to freshwater returns of age 3 cohorts for the 1971-88 brood years ( $r = 0.85$ ,  $P < 0.001$  for data transformed to natural logarithms). Data from the 1979 brood year were excluded from the analysis because those fish were resident in the ocean during the El Niño event of 1982-83. The ocean abundance of age 4 fish from the 1979 brood year appeared

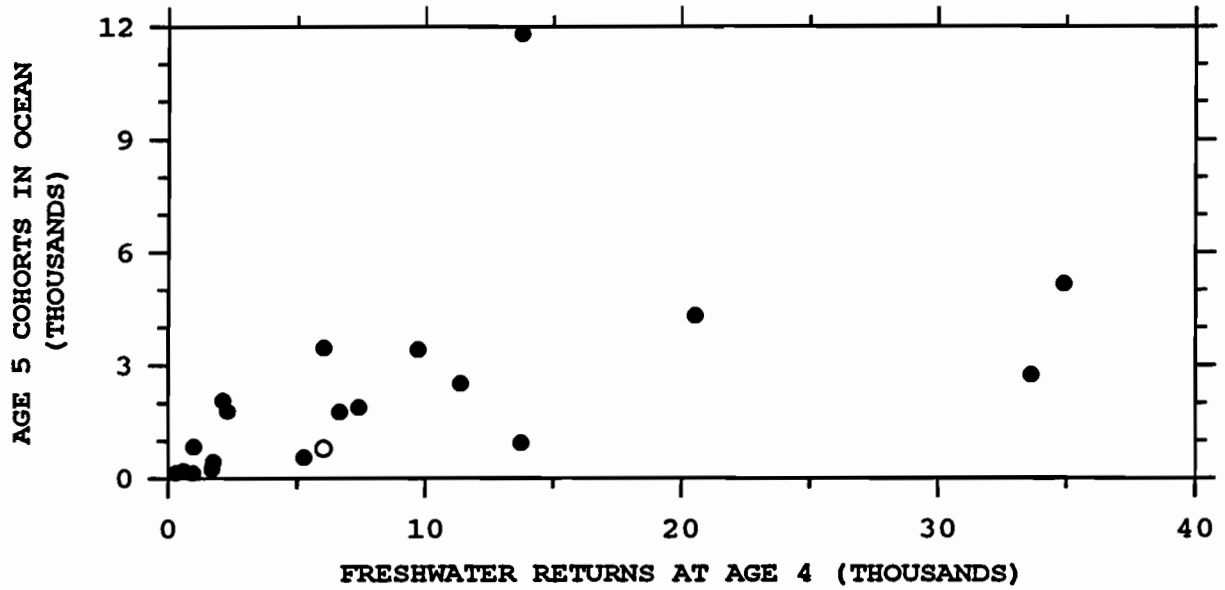

Figure 37. Estimated number of age 5 spring chinook salmon of hatchery origin in the ocean during spring as compared to the estimated freshwater return of age 4 cohorts one year earlier, 1970-89 brood years. Estimates include only those smolts released after 1 August. Open circle represents the brood year exposed to the El Niño event of 1982-83.

to be unusually low based on the number of age 3 fish that returned to the Rogue River in 1982 (Figure 38).

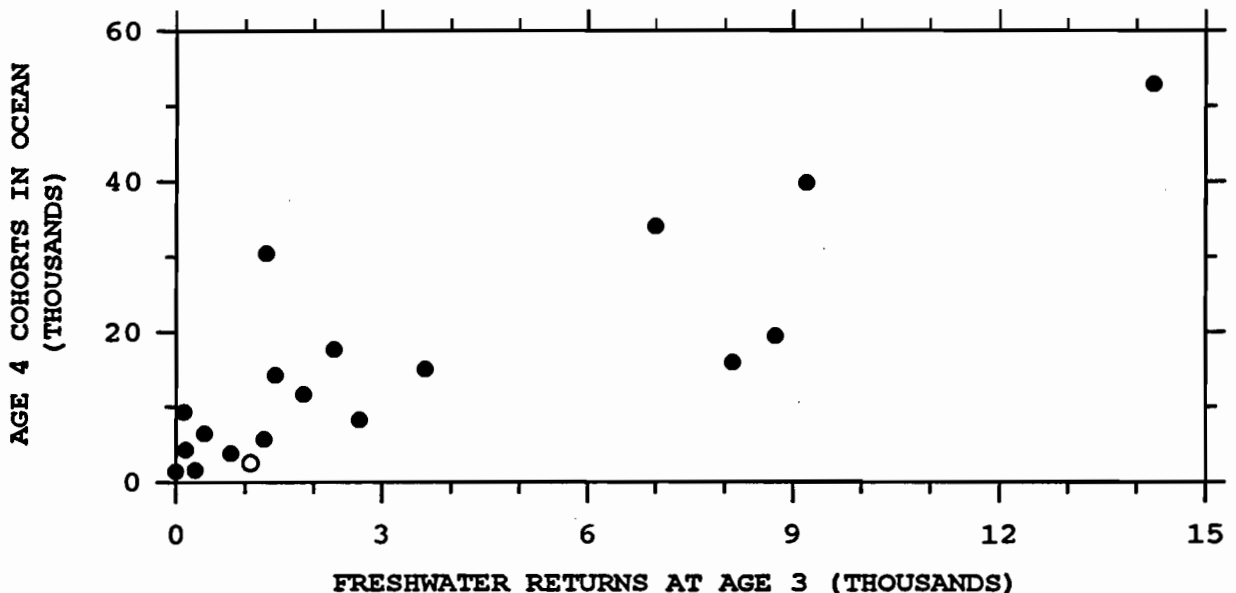

Figure 38. Estimated number of age 4 spring chinook salmon of hatchery origin in the ocean during spring as compared to the estimated freshwater return of age 3 cohorts one year earlier, 1971-89 brood years. Estimates include only those smolts released after 1 August. Open circle represents the brood year exposed to the El Niño event of 1982-83.

We predicted that 8,641 (95% CI = 2,498-29,894) age 4 hatchery fish from the 1979 brood year should have been resident in the ocean in spring of 1983 from a regression of the ocean abundance of age 4 fish on freshwater returns of age 3 cohorts for the 1971-88 brood years. The observed number of fish (2,500) was 29% of the predicted number of fish (8,641). We assumed that the El Niño event of 1982-83 was responsible for an increase in the natural mortality rate and changed the assumed winter survival rate of 0.8 to 0.23 ( $0.8 \times 0.29$ ) for age 3-4 fish from the 1979 brood year to better estimate the number of age 3 resident in the ocean during 1982. Data included in the analysis are in Appendix Table E-33.

Estimates of the number of age 3 hatchery fish resident in the ocean during spring of 1974-94 averaged 33,654 fish and ranged between 2,855 and 119,200 fish. Numbers of age 3 fish averaged 18,945 fish from the 1971-76 brood years and 40,442 fish from the 1977-89 brood years.

Estimates of the number of age 3 hatchery fish resident in the ocean were significantly related to freshwater returns of age 2 cohorts for the 1972-88 brood years ( $r = 0.70$ ,  $P = 0.002$  for data transformed to natural logarithms). Data from the 1980 brood year were excluded from the analysis because those fish were resident in the ocean during the El Niño event of 1982-83. The ocean abundance of age 3 fish from the 1980 brood year appeared to be unusually low based on the number of age 2 fish that returned to the Rogue River in 1982 (Figure 39).

We predicted that 43,310 (95% CI = 8,878-211,287) age hatchery 3 fish from the 1980 brood year should have been resident in the ocean in spring of

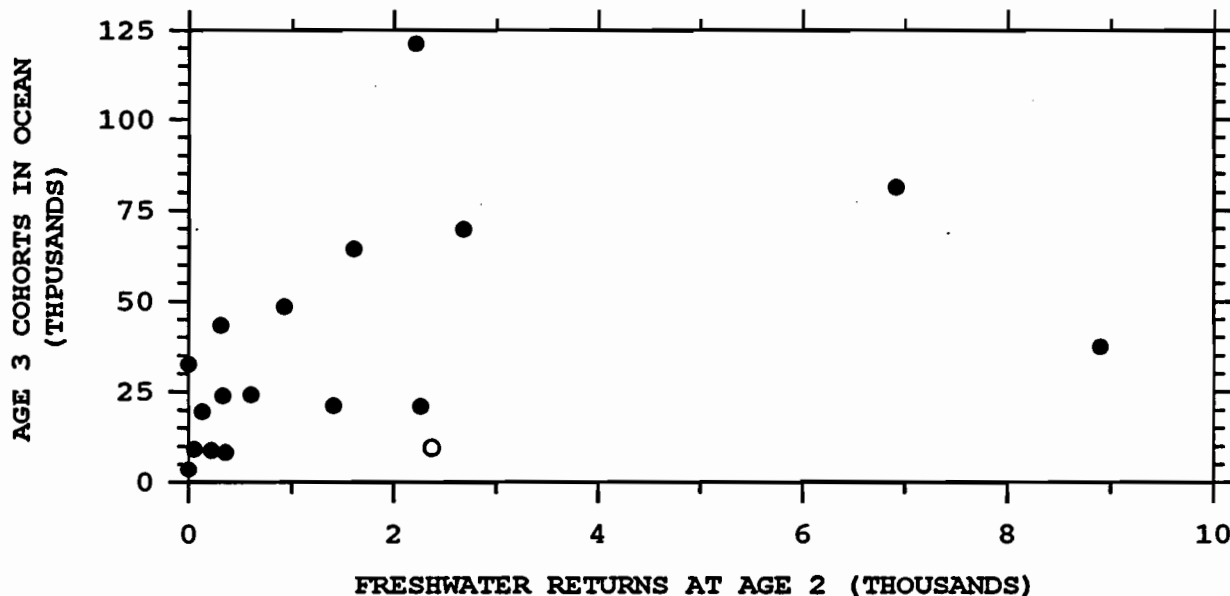

Figure 39. Estimated number of age 3 spring chinook salmon of hatchery origin in the ocean during spring as compared to the estimated freshwater return of age 2 cohorts one year earlier, 1972-89 brood years. Estimates include only those smolts released after 1 August. Open circle represents the brood year exposed to the El Niño event of 1982-83.



1983 from a regression of the ocean abundance of age 3 fish on freshwater returns of age 2 cohorts for the 1971-88 brood years. The observed number of fish (9,393) was 22% of the predicted number of fish (43,310). We assumed that the El Niño event of 1982-83 was responsible for an increase in the natural mortality rate and changed the assumed winter survival rate of 0.5 to 0.17 ( $0.5 \times 0.35$ ) for age 2-3 fish from the 1980 brood year to better estimate the number of age 3 resident in the ocean during 1982. Data included in the analysis are in Appendix Table E-33.

Estimates of the number of age 2 hatchery fish resident in the ocean during spring of 1974-94 averaged 78,161 fish and ranged between 7,395 and 249,192 fish. Numbers of age 2 fish averaged 47,561 fish from the 1972-76 brood years and 89,930 fish from the 1977-89 brood years.

We hypothesized that numbers of age 2 fish were primarily affected by (1) number of juveniles released, (2) size at time of release, (3) date of release, and (4) physical parameters of the ocean during, and just after, time of release from the hatchery.

We found that the number of age 2 fish from the 1972-89 broods was positively related to the number of smolts released from the hatchery (Figure 40). Numbers of age 2 recruits increased as the number of smolts increased. A regression analysis (Appendix Table E-34) suggested that an additional 67,000 age 2 fish were produced for every million smolts that were released.

Residual variation from the relationship between juveniles and age 2 recruits was negatively related to upwelling during autumn, as indexed by

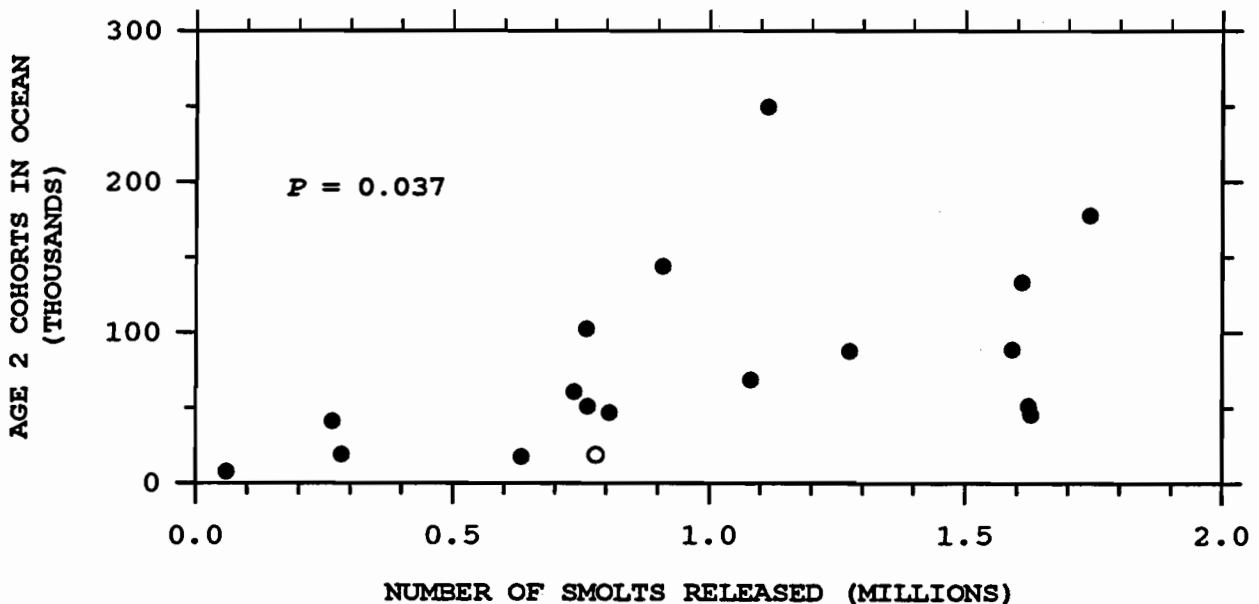

Figure 40. Estimated number of age 2 spring chinook salmon of hatchery origin in the ocean during spring as compared to the number of juveniles released one year earlier at Cole M. Rivers Hatchery, 1972-89 brood years. Estimates include only those smolts released after 1 August. Open circle represents the brood year exposed to the El Niño event of 1982-83.

daily measurements near Crescent City, California (Appendix Table E-34). Numbers of age 2 recruits increased as upwelling in autumn decreased. Residual variation from this relationship was not significantly related to any of the other independent variables that we examined (Appendix Table E-34).

Upwelling and smolt numbers accounted for only 35% of the variation in the number of age 2 hatchery fish estimated to reside in the ocean. A plot of residual variation from the relationship on time indicated that the regression failed to accurately predict the increase in survival following the El Niño event of 1982-83 and the decrease in survival in the late 1980s (Figure 41). Consequently, we concluded that we were unable to determine the factors that affected the number of hatchery fish alive in the ocean at age 2, with the exception that increased numbers of smolts resulted in increased numbers of age 2 recruits. A correlation matrix that outlines the relationships among all variables examined the regression analysis is in Appendix Table E-35. Data included in the analysis are in Appendix Table E-36.

Analysis of data from 169 groups of Ad-CWT marked fish released from Cole M. Rivers Hatchery produced different results. We hypothesized that the number of age 2 fish estimated to be alive in the ocean was affected by (1) number of juveniles released, (2) size at time of release, (3) date of release, and (4) physical parameters of the ocean during, and just after, time of release from the hatchery.

A multiple regression analysis indicated that all of the hypothesized factors were significantly related to numbers of Ad-CWT marked juveniles estimated to be alive in the ocean at age 2 (Appendix Table E-37). Fish abundance at age 2 was positively related to the number of juveniles released from the hatchery and juvenile weight at time of release. Date of release from the hatchery, ocean temperature in autumn and winter, and upwelling in

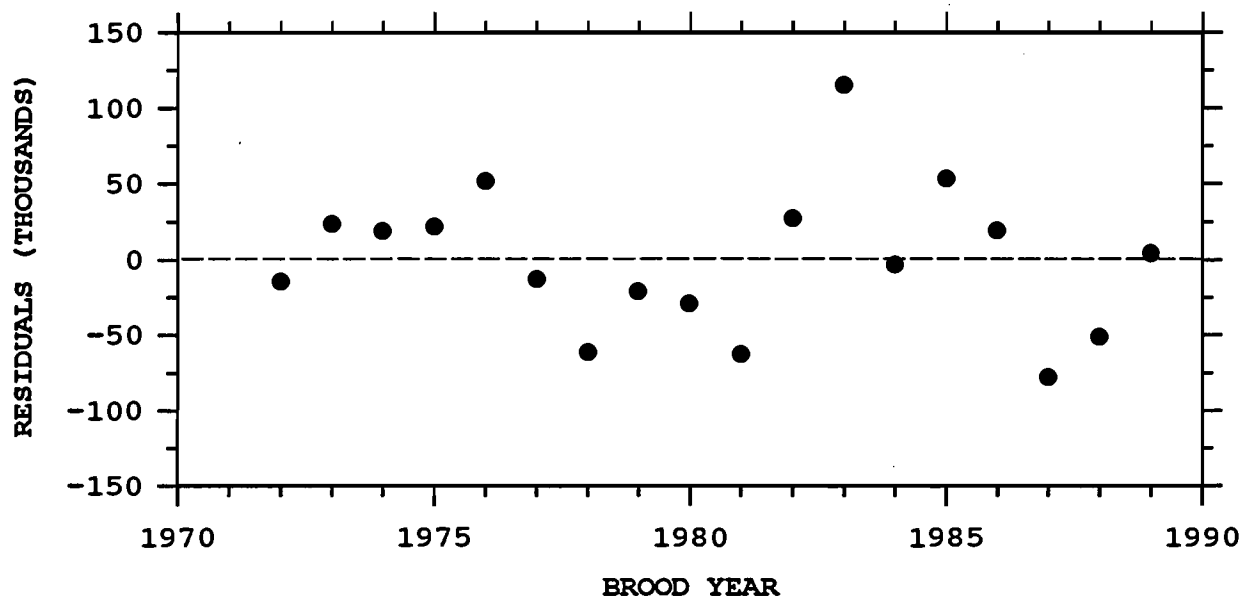

Figure 41. Residuals from the regression analysis of the number of age 2 hatchery fish as compared to time, 1972-89 brood years.

autumn and winter were negatively related to the number of age 2 fish. The seven independent variables accounted for 62% of the variation in the abundance of age 2 fish.

A plot of values predicted from the regression on observed values indicated that the regression tended to under-predict numbers of Ad-CWT marked fish alive at age 2 when the number of age 2 recruits exceeded 3,000 fish (Figure 42). This finding suggested that use of the regression for predictive purposes would be inappropriate for those brood years that survive at high rates. Consequently, we concluded that we were unable to determine the factors that affected the number of Ad-CWT marked fish alive in the ocean at age 2, with the exception that increased numbers of smolts resulted in increased numbers of age 2 recruits. A correlation matrix that outlines the relationships among all variables examined the regression analysis is in Appendix Table E-38.

A plot of residual variation from the relationship on time indicated that survival varied greatly for groups of Ad-CWT marked fish released in 1975-84, but that groups released in 1985-90 survived at rates that were consistently predicted by the model (Figure 43). These findings suggest that continuation of the release of three Ad-CWT groups monthly in August, September, and October may later result in an improved assessment of factors that affect the production of age 2 hatchery fish.

**All Spring Chinook Salmon:** Estimates of the number of age 6 fish resident in the ocean during spring of 1974-94 averaged 181 fish and ranged between 0 and 815 fish. Numbers of age 6 fish averaged 249 fish from the 1968-76 brood years and 129 fish from the 1977-88 brood years. We found that the median number of age 6 fish in the ocean before and after reservoir operation differed significantly (Mann-Whitney  $U = 126.0$ ,  $P = 0.060$ ). Data

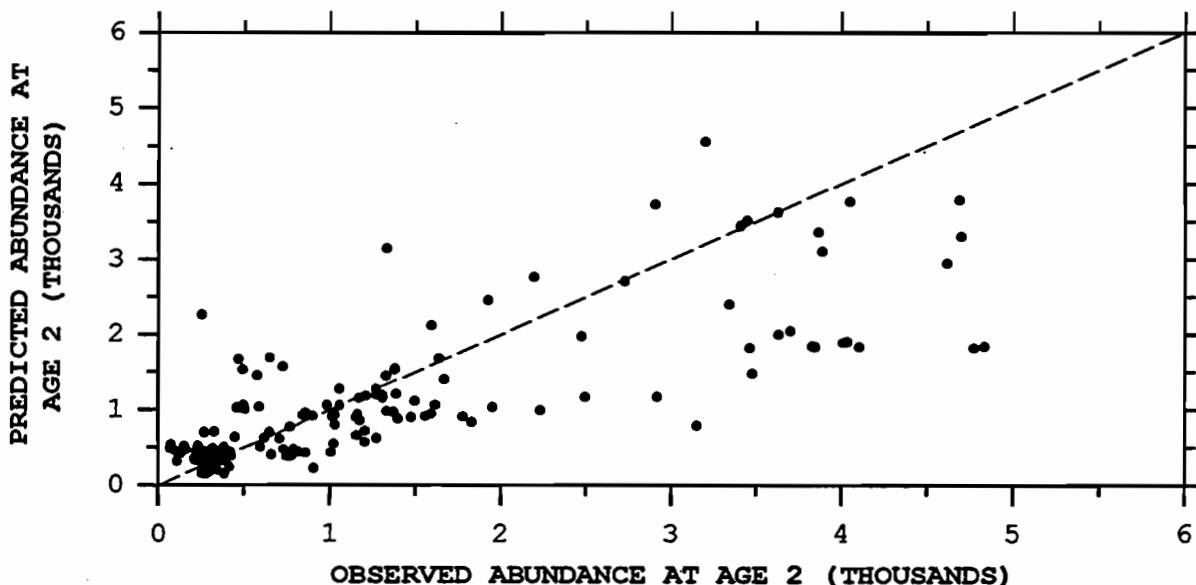

Figure 42. Number of age 2 Ad-CWT marked spring chinook salmon predicted by a regression analysis of 169 tag groups as compared to the estimates used to develop the regression.

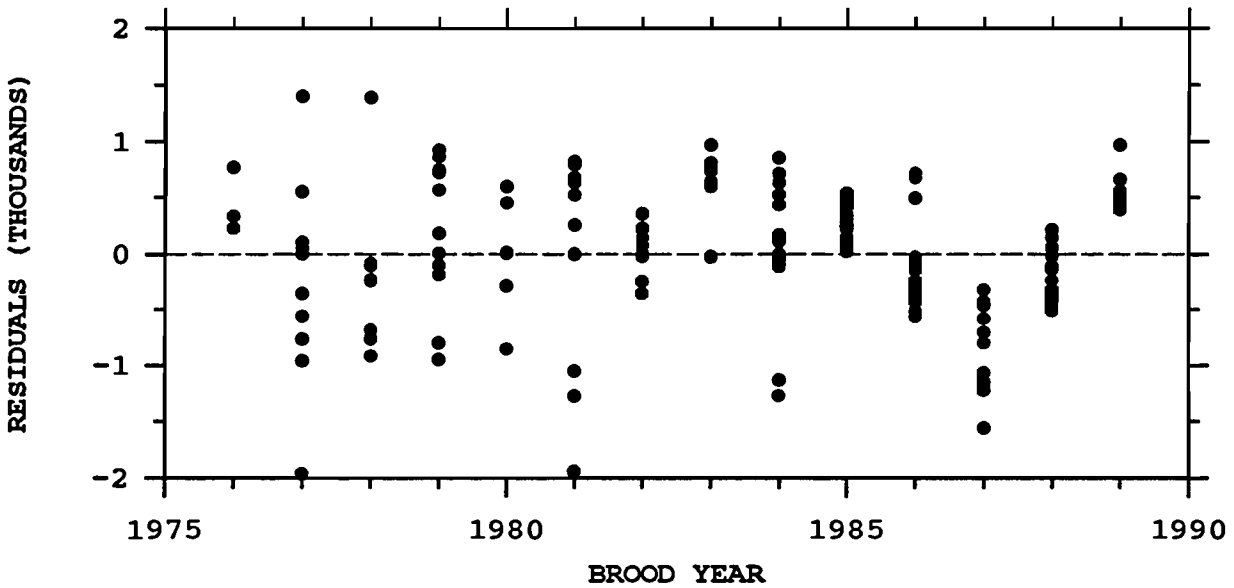

Figure 43. Residuals from the regression analysis of the number of age 2 Ad-CWT marked spring chinook salmon from 169 tag groups as compared to time.

included in the analysis are presented in Appendix Table E-18 as freshwater returns because all age 6 fish in the ocean matured and returned to freshwater.

Estimates of the number of age 5 fish resident in the ocean during spring of 1974-94 averaged 6,126 fish and ranged between 633 and 11,018 fish. Numbers of age 5 fish averaged 4,800 fish from the 1969-76 brood years and 2,589 fish from the 1977-88 brood years. We found that the mean number of age 5 fish produced before and after the operation of Lost Creek Dam differed significantly ( $F = 9.73$ ,  $P = 0.006$ ). Data included in the analysis are in Appendix Tables E-28 and E-33.

Estimates of the number of age 4 fish resident in the ocean during spring of 1974-94 averaged 41,974 fish and ranged between 9,511 and 95,568 fish. Numbers of age 4 fish averaged 52,566 fish from the 1970-76 brood years and 36,271 fish from the 1977-89 brood years. We found that the mean number of age 4 fish in the ocean before and after reservoir operation did not differ significantly ( $F = 2.48$ ,  $P = 0.133$ ). Data included in the analysis are in Appendix Tables E-28 and E-33.

Estimates of the number of age 3 fish resident in the ocean during spring of 1974-94 averaged 94,407 fish and ranged between 28,394 and 225,615 fish. Numbers of age 3 fish averaged 123,464 fish from the 1971-76 brood years and 80,996 fish from the 1977-89 brood years. We found that the mean number of age 3 fish in the ocean before and after reservoir operation did not differ significantly ( $F = 2.56$ ,  $P = 0.128$ ). Data included in the analysis are in Appendix Tables E-28 and E-33.

Estimates of the number of age 2 fish resident in the ocean during spring of 1974-94 averaged 214,673 fish and ranged between 62,025 and 475,133 fish. Numbers of age 2 fish averaged 288,604 fish from the 1972-76 brood years and 186,238 fish from the 1977-89 brood years. We found that the mean number of age 2 fish in the ocean before and after reservoir operation did not

differ significantly ( $F = 2.99$ ,  $P = 0.103$ ). Data included in the analysis are in Appendix Tables E-28 and E-33.

**Wild Fall Chinook Salmon:** Estimates of the number of age 6 fish resident in the ocean during spring of 1974-94 averaged 18 fish and ranged between 0 and 224 fish. Numbers of age 6 fish averaged 11 fish from the 1968-76 brood years and 24 fish from the 1977-88 brood years. We found that the median number of age 6 fish in the ocean before and after reservoir operation did not differ significantly (Mann-Whitney  $U = 106.5$ ,  $P = 0.616$ ).

Estimates of the number of wild age 5 fish resident in the ocean during spring of 1974-94 averaged 635 fish and ranged between 114 and 3,487 fish. Numbers of age 5 fish averaged 900 fish from the 1969-76 brood years and 458 fish from the 1977-88 brood years. We found that the mean number of age 5 fish in the ocean before and after reservoir operation did not differ significantly ( $F = 1.77$ ,  $P = 0.199$ ). Data included in the analysis are in Appendix Table E-39.

Estimates of the number of wild age 4 fish resident in the ocean during spring of 1974-94 averaged 5,102 fish and ranged between 2,195 and 18,449 fish. Numbers of age 4 fish averaged 6,720 fish from the 1970-76 brood years and 4,231 fish from the 1977-89 brood years. We found that the median number of age 4 fish in the ocean before and after reservoir operation did not differ significantly (Mann-Whitney  $U = 90.0$ ,  $P = 0.205$ ). Data included in the analysis are in Appendix Table E-39.

Estimates of the number of wild age 3 fish resident in the ocean during spring of 1974-94 averaged 12,668 fish and ranged between 5,272 and 38,163 fish. Numbers of age 3 fish averaged 16,515 fish from the 1971-76 brood years and 10,893 fish from the 1977-89 brood years. We found that the mean number of age 3 fish in the ocean before and after reservoir operation did not differ significantly ( $F = 1.62$ ,  $P = 0.220$ ). Data included in the analysis are in Appendix Table E-39.

Estimates of the number of wild age 2 fish resident in the ocean during spring of 1974-94 averaged 30,582 fish and ranged between 11,618 and 85,456 fish. Numbers of age 2 fish averaged 40,483 fish from the 1972-76 brood years and 26,774 fish from the 1977-89 brood years. We found that the mean number of age 2 fish in the ocean before and after reservoir operation did not differ significantly ( $F = 1.67$ ,  $P = 0.215$ ). Data included in the analysis are in Appendix Table E-39.

**Fall Chinook Salmon of Hatchery Origin:** We estimated that no age 6 hatchery fish were resident in the ocean during spring of 1974-94. Estimates of the number of age 5 hatchery fish resident in the ocean during spring of 1974-94 averaged 42 fish and ranged between 0 and 177 fish. Numbers of age 5 fish averaged 29 fish from the 1969-76 brood years and 51 fish from the 1977-88 brood years. Data included in the analysis are in Appendix Table E-40.

Estimates of the number of age 4 hatchery fish resident in the ocean during spring of 1974-94 averaged 533 fish and ranged between 0 and 1,571 fish. Numbers of age 4 fish averaged 217 fish from the 1970-76 brood years and 704 fish from the 1977-89 brood years. Data included in the analysis are in Appendix Table E-40.

Estimates of the number of age 3 hatchery fish resident in the ocean during spring of 1974-94 averaged 1,506 fish and ranged between 0 and 4,923 fish. Numbers of age 3 fish averaged 550 fish from the 1971-76 brood years and 1,948 fish from the 1977-89 brood years. Data included in the analysis are in Appendix Table E-40.

Estimates of the number of age 2 hatchery fish resident in the ocean during spring of 1974-94 averaged 3,772 fish and ranged between 0 and 12,269 fish. Numbers of age 2 fish averaged 1,411 fish from the 1972-76 brood years and 4,680 fish from the 1977-89 brood years. Data included in the analysis are in Appendix Table E-40.

**All Fall Chinook Salmon:** Estimates of the number of age 6 fish resident in the ocean during spring of 1974-94 averaged 18 fish and ranged between 0 and 224 fish. Numbers of age 6 fish averaged 11 fish from the 1968-76 brood years and 24 fish from the 1977-88 brood years. We found that the median number of age 6 fish in the ocean before and after reservoir operation did not differ significantly (Mann-Whitney  $U = 106.5$ ,  $P = 0.616$ ). Data included in the analysis are in Appendix Tables E-39 and E-40.

Estimates of the number of wild age 5 fish resident in the ocean during spring of 1974-94 averaged 676 fish and ranged between 117 and 3,631 fish. Numbers of age 5 fish averaged 928 fish from the 1969-76 brood years and 508 fish from the 1977-88 brood years. We found that the median number of age 5 fish in the ocean before and after reservoir operation did not differ significantly (Mann-Whitney  $U = 94.0$ ,  $P = 0.464$ ). Data included in the analysis are in Appendix Tables E-39 and E-40.

Estimates of the number of age 4 fish resident in the ocean during spring of 1974-94 averaged 5,636 fish and ranged between 2,526 and 19,322 fish. Numbers of age 4 fish averaged 6,936 fish from the 1970-76 brood years and 4,935 fish from the 1977-89 brood years. We found that the median number of age 4 fish in the ocean before and after reservoir operation did not differ significantly (Mann-Whitney  $U = 78.0$ ,  $P = 0.751$ ). Data included in the analysis are in Appendix Tables E-39 and E-40.

Estimates of the number of age 3 fish resident in the ocean during spring of 1974-94 averaged 14,175 fish and ranged between 5,783 and 39,818 fish. Numbers of age 3 fish averaged 17,065 fish from the 1971-76 brood years and 12,841 fish from the 1977-89 brood years. We found that the mean number of age 3 fish in the ocean before and after reservoir operation did not differ significantly ( $F = 0.76$ ,  $P = 0.511$ ). Data included in the analysis are in Appendix Tables E-39 and E-40.

Estimates of the number of age 2 fish resident in the ocean during spring of 1974-94 averaged 34,353 fish and ranged between 12,948 and 88,992 fish. Numbers of age 2 fish averaged 41,893 fish from the 1972-76 brood years and 31,453 fish from the 1977-89 brood years. We found that the mean number of age 2 fish in the ocean before and after reservoir operation did not differ significantly ( $F = 0.80$ ,  $P = 0.385$ ). Data included in the analysis are in Appendix Tables E-39 and E-40.

**All Wild Chinook Salmon:** Estimates of the number of age 6 fish resident in the ocean during spring of 1974-94 averaged 161 fish and ranged

between 0 and 774 fish. Numbers of age 6 fish averaged 225 fish from the 1968-76 brood years and 113 fish from the 1977-88 brood years. We found that the median number of age 6 fish in the ocean before and after reservoir operation differed significantly (Mann-Whitney  $U = 130.0$ ,  $P = 0.030$ ). Data included in the analysis are in Appendix Tables E-28 and E-39.

Estimates of the number of wild age 5 fish resident in the ocean during spring of 1974-94 averaged 5,078 fish and ranged between 511 and 12,628 fish. Numbers of age 5 fish averaged 8,125 fish from the 1969-76 brood years and 3,047 fish from the 1977-88 brood years. We found that the median number of age 5 fish in the ocean before and after reservoir operation differed significantly (Mann-Whitney  $U = 130.0$ ,  $P < 0.001$ ). Data included in the analysis are in Appendix Tables E-28 and E-39.

Estimates of the number of wild age 4 fish resident in the ocean during spring of 1974-94 averaged 32,372 fish and ranged between 8,224 and 73,430 fish. Numbers of age 4 fish averaged 52,164 fish from the 1970-76 brood years and 21,715 fish from the 1977-89 brood years. We found that the median number of age 4 fish in the ocean before and after reservoir operation differed significantly (Mann-Whitney  $U = 111.0$ ,  $P = 0.003$ ). Data included in the analysis are in Appendix Tables E-28 and E-39.

Estimates of the number of wild age 3 fish resident in the ocean during spring of 1974-94 averaged 73,422 fish and ranged between 15,340 and 172,052 fish. Numbers of age 3 fish averaged 121,034 fish from the 1971-76 brood years and 51,447 fish from the 1977-89 brood years. We found that the mean number of age 3 fish in the ocean before and after reservoir operation differed significantly ( $F = 14.37$ ,  $P = 0.002$ ). Data included in the analysis are in Appendix Tables E-28 and E-39.

Estimates of the number of wild age 2 fish resident in the ocean during spring of 1974-94 averaged 167,094 fish and ranged between 34,532 and 376,805 fish. Numbers of age 2 fish averaged 281,526 fish from the 1972-76 brood years and 123,081 fish from the 1977-89 brood years. We found that the mean number of age 2 fish in the ocean before and after reservoir operation differed significantly ( $F = 13.57$ ,  $P = 0.002$ ). Data included in the analysis are in Appendix Tables E-28 and E-39.

We hypothesized that numbers of age 2 fish were primarily affected by (1) juvenile abundance, (2) rate of freshwater growth and size at ocean entry, (3) river flow and water temperature during summer, and (4) ocean physical parameters during the period when smolts entered the ocean. The two indexes of juvenile abundance were highly correlated (see Abundance, page 67), so we only included estimates of the number of subyearlings that passed Savage Rapids Dam as an independent variable.

We were unable to identify the primary factors that affected the number of wild age 2 fish from the 1974-89 brood years. Regression analysis indicated that numbers of age 2 fish were negatively related to the number of juvenile migrants and were positively related to water temperature of the Rogue River in summer. These relationships do not seem plausible because recruitment should be positively related to juvenile production and should be negatively related to water temperature.

We plotted estimates of the number of wild age 2 fish resident in the ocean on estimates of the number of cohorts that migrated as subyearlings and found that numbers of age 2 fish from the 1974-84 brood years appeared to be positively related to estimates of juvenile production (Figure 44). Data from the 1985-89 brood years did not fit the relationship (Figure 44). This finding suggested that there was a marked decrease in ocean survival rates during the late 1980s as compared to earlier years. As a result, we again analyzed factors that may have affected the number of age 2 fish, but limited the analysis to data from only the 1974-84 brood years.

We found that the estimated numbers of age 2 fish from the 1974-84 broods were positively related to estimated numbers of subyearling cohorts that migrated past Savage Rapids Dam in late spring and early summer. Numbers of age 2 recruits increased as the number of juveniles increased. A regression analysis (Appendix Table E-41) suggested that an additional 74,000 age 2 fish were produced for every million subyearling migrants. Annual estimates of subyearling migrants produced by the 1974-84 brood years ranged between 300,000 and 5,000,000 fish.

Residual variation from the relationship between juveniles and age 2 recruits was negatively related to ocean temperature during summer, as indexed by daily measurements at Charleston, Oregon. Numbers of age 2 recruits increased as the surface temperature of the ocean decreased. The regression analysis (Appendix Table E-41) suggested that an additional 125,000 age 2 fish were produced for every 1°C decrease in mean ocean temperature during summer. Mean water temperatures in summer at Charleston ranged between 11.6°C and 14.2°C in 1975-85.

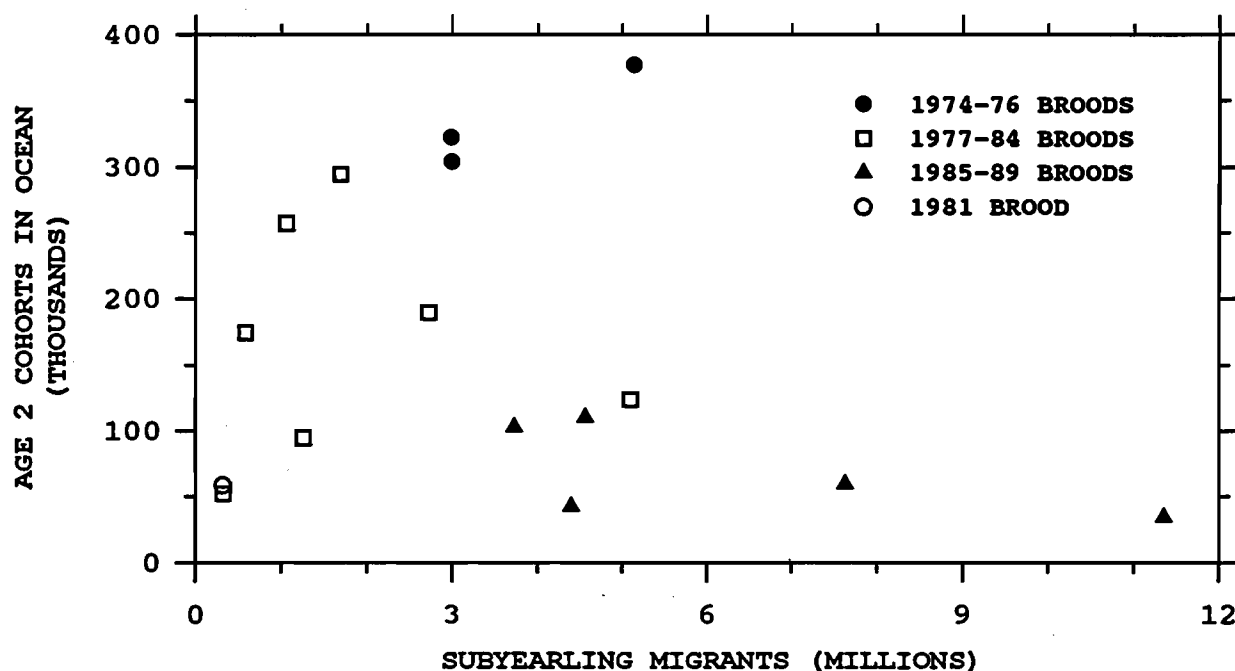

Figure 44. Estimated number of wild age 2 chinook salmon in the ocean during spring as compared to the estimated number of subyearlings that passed Savage Rapids Dam one year earlier, 1974-89 brood years. Open circle represents the brood year exposed to the El Niño event of 1982-83.



Residual variation from the second step in the regression was positively related to estimates of smolt lengths at the time of ocean entry. Numbers of age 2 recruits increased as smolts entered the ocean at a larger size. The regression analysis (Appendix Table E-41) suggested that an additional 125,000 age 2 fish were produced for every one centimeter increase in mean length. We estimated that mean lengths ranged between 10.2 and 11.7 cm for the 1974-84 brood years. These estimates apply only to those fish that survived to age 2 because smolt lengths were estimated from scales of adult fish.

Results of the multiple regression must be interpreted with caution. Inclusion of 3 independent variables is excessive for a regression analysis with only 11 years of data. However, we have some confidence in the results because the effects of each independent variable on salmonid production is documented in the literature, and the independent variables in the regression were not intercorrelated.

**All Chinook Salmon of Hatchery Origin:** Estimates of the number of age 6 hatchery fish resident in the ocean during spring of 1974-94 averaged 37 fish and ranged between 0 and 232 fish. Numbers of age 6 fish averaged 34 fish from the 1968-76 brood years and 40 fish from the 1977-88 brood years. Data included in the analysis are in Appendix Tables E-33 and E-40.

Estimates of the number of age 5 hatchery fish resident in the ocean during spring of 1974-94 averaged 1,724 fish and ranged between 144 and 5,265 fish. Numbers of age 5 fish averaged 918 fish from the 1969-76 brood years and 2,262 fish from the 1977-88 brood years. Data included in the analysis are in Appendix Tables E-33 and E-40.

Estimates of the number of age 4 hatchery fish resident in the ocean during spring of 1974-94 averaged 15,238 fish and ranged between 868 and 54,017 fish. Numbers of age 4 fish averaged 7,339 fish from the 1970-76 brood years and 19,491 fish from the 1977-89 brood years. Data included in the analysis are in Appendix Tables E-33 and E-40.

Estimates of the number of age 3 hatchery fish resident in the ocean during spring of 1974-94 averaged 35,160 fish and ranged between 2,855 and 124,123 fish. Numbers of age 3 fish averaged 19,495 fish from the 1971-76 brood years and 42,390 fish from the 1977-89 brood years. Data included in the analysis are in Appendix Tables E-33 and E-40.

Estimates of the number of age 2 hatchery fish resident in the ocean during spring of 1974-94 averaged 81,933 fish and ranged between 7,395 and 261,461 fish. Numbers of age 2 fish averaged 48,972 fish from the 1972-76 brood years and 94,610 fish from the 1977-89 brood years. Data included in the analysis are in Appendix Tables E-33 and E-40.

**All Chinook Salmon:** Estimates of the number of age 6 fish resident in the ocean during spring of 1974-94 averaged 199 fish and ranged between 0 and 947 fish. Numbers of age 6 fish averaged 260 fish from the 1968-76 brood years and 153 fish from the 1977-88 brood years. We found that the median number of age 6 fish in the ocean before and after reservoir operation differed significantly (Mann-Whitney  $U = 123.0$ ,  $P = 0.095$ ). Data included in the analysis are in Appendix Tables E-28, E-33, E-39, and E-40.

Estimates of the number of age 5 fish resident in the ocean during spring of 1974-94 averaged 6,803 fish and ranged between 755 and 14,649 fish. Numbers of age 5 fish averaged 9,043 fish from the 1969-76 brood years and 5,309 fish from the 1977-88 brood years. We found that the median number of age 5 fish in the ocean before and after reservoir operation differed significantly ( $F = 8.76$ ,  $P = 0.008$ ). Data included in the analysis are in Appendix Tables E-28, E-33, E-39, and E-40.

Estimates of the number of age 4 fish resident in the ocean during spring of 1974-94 averaged 47,610 fish and ranged between 12,178 and 101,092 fish. Numbers of age 4 fish averaged 59,503 fish from the 1970-76 brood years and 41,206 fish from the 1977-89 brood years. We found that the median number of age 4 fish in the ocean before and after reservoir operation did not differ significantly (Mann-Whitney  $U = 94.0$ ,  $P = 0.113$ ). Data included in the analysis are in Appendix Tables E-28, E-33, E-39, and E-40.

Estimates of the number of age 3 fish resident in the ocean during spring of 1974-94 averaged 108,582 fish and ranged between 34,219 and 243,110 fish. Numbers of age 3 fish averaged 140,529 fish from the 1971-76 brood years and 93,837 fish from the 1977-89 brood years. We found that the mean number of age 3 fish in the ocean before and after reservoir operation did not differ significantly ( $F = 2.47$ ,  $P = 0.134$ ). Data included in the analysis are in Appendix Tables E-28, E-33, E-39, and E-40.

Estimates of the number of age 2 fish resident in the ocean during spring of 1974-94 averaged 249,027 fish and ranged between 76,289 and 518,768 fish. Numbers of age 2 fish averaged 330,498 fish from the 1972-76 brood years and 217,692 fish from the 1977-89 brood years. We found that the mean number of age 2 fish in the ocean before and after reservoir operation did not differ significantly ( $F = 2.85$ ,  $P = 0.111$ ). Data included in the analysis are in Appendix Tables E-28, E-33, E-39, and E-40.

**Effects of the El Niño Event of 1982-83:** We concluded that the El Niño event of 1982-83 increased rates of natural mortality for spring chinook salmon resident in the ocean. Estimates of ocean abundance in 1983 were less than predicted based upon freshwater returns of cohorts in 1982 for age 2-3 fish and for age 3-4 fish. Numbers of wild and hatchery fish alive in spring of 1983, as estimated from the cohort analyses, represented only 13-42% of the number predicted from regression analyses (Table 35).

Because estimates of ocean abundance were affected by freshwater returns in later years, changes in maturity rates could have accounted for the low estimates of fish abundance in 1983. However, we believe increased rates of natural mortality mostly accounted for the low estimates of fish abundance in 1983. We reached this conclusion based on the low number of cohorts that returned to the Rogue River in 1984-86.

Other populations of salmon were also significantly affected by the El Niño event of 1982-83. Johnson (1988) estimated that the 1983 abundance of age 3 coho salmon in the Oregon Production Index Area was 42% of expected. Fisher and Percy (1988) concluded that increased rates of natural mortality of juvenile coho salmon that reared off the coasts of Oregon and Washington in 1983 and 1984 resulted from increased predation rather than a decreased food supply. They hypothesized that mortality rates may have increased because

Table 35. Comparisons of the predicted and estimated number of wild and hatchery spring chinook salmon alive in the ocean during 1983. Predictions were developed from regressions of the estimated number of fish alive in the ocean during spring on the freshwater escapement of cohorts in the previous year.

Fish type	Age	Brood year	Predicted (95% CI)	Observed	Percent of predicted
Wild	3	1980	69,042 (18,086-263,555)	24,064	35%
	4	1979	21,440 (12,103-37,979)	7,011	33%
Hatchery	3	1980	43,310 (8,878-211,287)	9,393	22%
	4	1979	8,641 (2,498-29,894)	2,500	29%
Hatchery (Ad-CWT)	3	1980	8,450 (2,904-24,586)	1,105	13%
	4	1979	2,569 (882-7,483)	1,091	42%

predation increased. In general, predation affects anadromous salmonids in a size-dependent manner (Ricker 1969; Ricker 1976; Mathews and Buckley 1976; Healey 1982). Our data indicated that predators would have had to have been large animals to account for the increased rates of natural mortality among age 2-4 spring chinook salmon. Effects of environmental factors other than El Niño are discussed further in the following section. Because the El Niño of 1982-83 is regarded as one of the strongest of the century (Mysak 1986), we deemed it to be an anomalous event.

**Discussion:** We that concluded that, beginning with age 2 fish, freshwater returns at age *i* and estimates of the ocean abundance of age *i*+1 cohorts tended to be linear for wild and hatchery fish. Changes in the cohort relationships were associated with significant events like the El Niño event of 1982-83, the construction and operation of Lost Creek Dam, and a change in broodstock selection practices at Cole M. Rivers Hatchery.

Other research has documented linear relationships among anadromous salmonids of successive ages. Johnson (1988) described a linear relationship between freshwater returns of age 2 jacks and the abundance of age 3 coho salmon in the Oregon Production Index Area. Peterman (1982) found linear relationships for four stocks of age 3-6 sockeye salmon in Alaska and British Columbia. Peterman (1982) also concluded there was a linear relationship between age 2-3 coho salmon in the Oregon Production Index Area. Correlation coefficients for these regressions averaged 0.72 and ranged between 0.40 and 0.96. The relationship between grilse harvest and two-sea winter Atlantic salmon in 15 Iceland rivers were judged to be linear or nearly linear by Scarnecchia (1984). Correlation coefficients for relationships of Atlantic salmon of successive ages averaged 0.73 and ranged between 0.52 and 0.93, but it is also known that ocean conditions can affect grilse-adult relationships (Gudjonsson et al. 1995). Preseason forecasts developed with linear relationships between successive age classes for four populations of chinook salmon in the Columbia River Basin differed, on the average, from actual returns by 17-28% (PFMC 1998a).

We found correlation coefficients between successive ages of fall chinook salmon averaged 0.73 and ranged between 0.55 and 0.86 for age 3-6 fish. Although these correlation coefficients are comparable to values derived from other research, the strong 1975 brood year was primarily responsible for coefficient values between fish of ages 4-6. Non-linear models have been judged to be more accurate predictors of abundance for some populations of sockeye salmon (Bocking and Peterman 1988).

In contrast, we were unable to identify any significant relationships between abundance indexes of juveniles in freshwater and the estimated ocean abundances of age 2 fish in the succeeding year. The lack of linear relationships between age 1 and age 2, as compared to successive age classes of older cohorts, seems to indicate that survival rates during the first six months after ocean entry is a primary determinant that affected recruitment to the ocean fisheries.

Environmental conditions in the ocean have been identified in numerous studies as important determinants for production of adult salmonids. Nickelson (1986) found negative relationships between ocean temperature in years of high upwelling and survival rates of wild and hatchery coho salmon in the Oregon Production Index Area. Marine survival of coho salmon originating from Carnation Creek, British Columbia, was positively correlated with ocean conditions indicative of strong upwelling (Holtby et al. 1990). Ocean temperature accounted for a significant amount of variation in the number of fall chinook salmon that returned to the Columbia River during 1938-46 (Van Hying 1973). Similar variations in fry-adult survival rates among wild and hatchery chinook salmon in New Zealand may indicate that adult production is primarily affected by factors during the first year of ocean residence (Unwin 1997a).

However, multiple freshwater factors are also primary determinants of salmonid production. Increased flow in a small Maine stream was associated with increased survival rate of subyearling Atlantic salmon (Havey and Davis 1970). Standing crops of resident trout are positively related with flow in late summer for streams of the western portion of the United States (Binns and Eiserman 1979; Conder and Annear 1987). Unwin (1997b) concluded that freshets may have increased the survival rate of juvenile chinook salmon that migrated from a New Zealand river which, like the Rogue River, had a relatively small estuary.

Flow in the first year of freshwater residence has been related to the production of coho salmon (Mathews and Olson 1980; Anderson and Wilen 1985). Barton (1979) concluded greater flow during juvenile migration to the ocean increased returns of adult spring chinook salmon to streams in the upper portion of the Columbia River Basin. Stevens and Miller (1983) found that the abundance of juvenile chinook salmon was positively correlated with flow into the Sacramento-San Joaquin river delta of California. Increased flow may have increased survival rate of juveniles that passed hydroelectric facilities (Connor et al. 1998). In contrast, Beamish et al. (1994) found indications that the abundance of chinook salmon in the Fraser River was negatively related to flow when juveniles entered the ocean. We were unable to find any relationship between flow of the Rogue River in the summer and the subsequent abundance of spring chinook salmon in the ocean.

Water temperature is another primary factor that limits the freshwater production of chinook salmon. Brett (1952) estimated an upper thermal tolerance limit of 25.1°C for juvenile chinook salmon reared in a laboratory. Eaton et al. (1994) reviewed data from field surveys and estimated that the maximum weekly mean temperature tolerance of 24.1°C for juvenile chinook salmon. Lindsay et al. (1986) could not find juvenile spring chinook salmon in portions of the John Day River Basin where water temperature exceeded 25°C. Conversely, Baker et al. (1995) estimated that the upper incipient lethal temperature was 23°C for Ad-CWT marked juvenile chinook passing through the Sacramento-San Joaquin delta in California. Water temperature in portions of the Rogue River commonly exceeded 23°C when some juvenile spring chinook salmon migrated to the ocean, especially before reservoir operation, but we were unable to detect the effects of decreased water temperature on subsequent production of adult fish.

Spawning distribution also has been shown to affect the production of chinook salmon. Fustish et al. (1988) concluded that an increase in the spawning distribution of fall chinook salmon in the Applegate River increased the juvenile production. In contrast, Bradford (1994) reported that the survival rate of chinook salmon in the Nechako River, British Columbia, was negatively related to the proportion of adults that spawned in upstream areas influence by reservoir releases.

Biological characteristics of migrants appeared to have little affect on ocean recruitment of spring chinook salmon of Rogue River origin. However, failure to detect affects may have resulted from small sample sizes or narrow ranges observed within biological characteristics. For example, mean lengths of juvenile migrants varied less than 1.5 cm annually. Experiments designed to evaluate the influence of size on survival of hatchery fish used groups of more varied sizes.

Bilton (1984) estimated freshwater returns to be five times greater for chinook salmon released at mean weights of 12 g compared with 6 g. Green and Macdonald (1987) concluded release time and size at release affected the number of chinook salmon that returned to Robertson Creek in British Columbia. However, unspecified variation in survival rates between brood years had a greater affect on adult returns than release time or size at release. This finding suggested environmental conditions after release from hatcheries strongly affect survival rates of chinook salmon.

As we found with releases of hatchery fish, time of migration can be an important factor that affects smolt-to-adult survival rates. Evenson and Ewing (1990) concluded that the survival rates increased for subyearling spring chinook released at Cole M. Rivers Hatchery in summer as compared to autumn, winter, or spring releases of yearling smolts. Time of release experiments with coho salmon (Mathews and Ishida 1989) and steelhead tend to show a more pronounce effect of release time, possibly because those species naturally migrate as smolts during a narrow time period in spring while life history data indicates a wide time of ocean entry within and among populations of chinook salmon (Nicholas and Hankin 1988; Taylor 1990).

In addition to the troll and recreational fisheries, chinook salmon are intercepted in other types of ocean fisheries. Bottom trawlers that fish for rockfish (*Sebastes spp.*) and mid-water trawlers that fish for Pacific whiting

(*Merluccius productus*) also capture some chinook salmon. Erickson and Pikitich (1994) found that catches bottom trawlers that fished in coastal areas of Washington and Oregon accounted for only 1.4% of the chinook salmon landed by all commercial fishermen who fished the same areas in 1987. ODFW (1997) estimated that catches of chinook salmon in the Pacific whiting fishery ranged between 2,165 and 14,069 fish annually in 1991-96.

Predators consume juvenile and adult chinook salmon. Roffe and Mate (1984) estimated that harbor seals and sea lions present in the estuary and in the river up to RK 13 consumed less than 1% of the spring chinook salmon that returned to the Rogue River in 1977 and 1978. Impacts may be greater now as the pinniped populations have increased since the 1970s.

Satterthwaite (1995) reported that Umpqua squawfish were major predators of juvenile fall chinook salmon in the Rogue River. Umpqua squawfish first entered the Rogue River at Grave Creek (RK 110) in 1979. At first, the population appeared to increase slowly because no juveniles were captured at the four seining sites in the middle river and in the canyon sampled through 1986. However, by 1993, Umpqua squawfish were widely distributed from the lower river upstream to at least Grants Pass (Satterthwaite 1995). Samples collected in the middle river during 1993-94 suggested that chinook salmon fry were a primary prey item in late spring for Umpqua squawfish longer than 20 cm (Satterthwaite 1995). By late summer, few juvenile chinook salmon were found in Umpqua squawfish shorter than 30 cm.

Beamesderfer et al. (1996) concluded that a low removal rate of northern squawfish (*Ptychocheilus oregonensis*) probably benefit salmon survival in the Columbia River if predator populations do not respond in a compensatory manner. Compensatory predation is even less likely in the Rogue River because other species of predacious fishes have yet to become established. With or without compensatory predation, fishery managers should encourage the removal of Umpqua squawfish from the Rogue River and should publicize that transplanting of squawfish decreases the production of anadromous salmonids.

Reservoir releases that decreased the water temperature of the Rogue River probably decreased the number of juvenile chinook salmon eaten by Umpqua squawfish. Metabolic rates of northern squawfish increase as water temperature increases between 9°C and 21°C (Cech et al. 1994). In addition, water temperature has been shown to be a primary determinate of the maximum number of juvenile salmonids consumed by northern squawfish. Vigg and Burley (1991) noted about a 6-fold increase in salmonid consumption as water temperature increased from 12.5°C to 21.5°C, while there appeared to be less than a 2-fold increase in consumption of larger salmonid prey over the same temperature range (Petersen and DeAngelis 1992). Wild juvenile spring chinook salmon tend to migrate downstream in July-October, so decreases in river temperature will decrease the number consumed by Umpqua squawfish.

Another benefit of lower water temperatures in the late spring and summer may be to minimize the upstream spread of Umpqua squawfish in the Rogue River. For example, there is evidence that abrupt decreases in water temperature will disrupt spawning by northern squawfish (Beamesderfer 1992). An investigation of the relationship between water temperature and the migration patterns of Umpqua squawfish may aid fisheries managers in deciding how to optimize releases of reservoir storage at USACE dams in the Rogue River Basin.

## Survival Rates between Age 1 and Age 2

**Spring Chinook Salmon of Hatchery Origin:** Estimates of survival rates to age 2 for Ad-CWT marked spring chinook salmon released from Cole M. Rivers Hatchery in September and October averaged 7.1% and ranged between 1.7% and 16.3% for the 1975-89 brood years (Appendix Table E-42). Estimates of survival rates to age 2 for spring chinook salmon of hatchery origin, as estimated from scale analysis of fish trapped at Gold Ray Dam, averaged 8.3% and ranged between 2.4% and 22.4% for the 1975-89 brood years (Appendix Table E-42). We found that estimates of mean survival rates to age 2 did not differ significantly between Ad-CWT marked fish and fish of hatchery origin trapped at Gold Ray Dam based on a paired t-test ( $t = 1.53$ ,  $P = 0.148$ ).

We also found that estimates of annual survival rates to age 2 were highly correlated ( $r = 0.83$ ,  $P < 0.001$ ) between Ad-CWT marked fish and for hatchery fish trapped at Gold Ray Dam. Survival rates were transformed to logits prior to analysis. The correlation between the two estimates of survival rates, in conjunction with the finding that mean survival rates did not differ, suggested that scale analyses of trapped fish produced reasonable estimates of the number of unmarked spring chinook salmon of hatchery origin that returned to the upper portion of the Rogue River.

Such pronounced differences in annual survival rates of Pacific salmon have been reported from other studies. Labelle et al. (1997) estimated that smolt-to-adult survival rates ranged between 0.5% and 23% among four brood years of 14 stocks of coho salmon produced on the east side of Vancouver Island. Similarly, Holtby et al. (1990) estimated that smolt-to-adult survival rates ranged between 4% and 30% for 17 brood years of coho salmon produced in Carnation Creek, British Columbia. Unwin (1997a) estimated that survival rates of chinook salmon released from New Zealand hatcheries at a mean weight of 38 g ranged between 0.01% and 3.3%.

**Chinook Salmon of Wild Origin:** We indexed the survival rates of wild juvenile chinook salmon from the estimated number of wild fish alive in the ocean at age 2 and the number of wild subyearling cohorts estimated to have passed Savage Rapids Dam. We could not directly estimate survival rates because we could not estimate the number of age 2 recruits produced by fall chinook salmon that spawned between Gold Ray Dam and Savage Rapids Dam. Consequently, the survival rate indexes calculated for wild fish are greater than the actual survival rates of wild chinook salmon produced in the upper river.

We found that annual indexes of survival rates for wild fish were not significantly correlated to annual survival rates of spring chinook salmon of hatchery origin ( $r = 0.31$ ,  $P = 0.247$ ) or to those of Ad-CWT marked spring chinook salmon ( $r = 0.45$ ,  $P = 0.090$ ). Survival rate indexes for wild fish tended to be greater than survival rate estimates for hatchery fish in the late 1970s and early 1980s, but that trend reversed in the late 1980s (Appendix Table E-42). Survival rates of wild fish may have decreased because juveniles migrated downstream earlier (see Time of Migration, page 88) and at smaller sizes in the late 1980s as compared to earlier years (see Size at Time of Migration, page 93).

## Recruitment Rates

We estimated that recruitment rates of wild spring chinook salmon averaged 10.7 fish per spawner and ranged from less than 1 fish per spawner to about 37 fish per spawner among the 1974-89 broods (Appendix Table E-43). For all wild chinook salmon from the 1974-89 brood years, recruitment rates averaged 10.0 fish per spawner and ranged from less than 1 fish per spawner to about 32 fish per spawner (Appendix Table E-43). The mean recruitment rates are comparable to other populations of chinook salmon on the Pacific coast of North America (Reisenbichler 1987).

Median recruitment rates of wild spring chinook salmon and all wild chinook salmon did not differ significantly for fish produced before and after operation of Lost Creek Dam (both  $P > 0.08$ ). A paucity of data for preimpoundment broods ( $n = 3$ ) and high recruitment rates for fish that entered the ocean after the El Niño event of 1982-83 were likely responsible for the lack of significant differences.

Excluding data from the 1983 and 1984 brood years, mean recruitment rates of wild spring chinook salmon were significantly greater for broods produced before reservoir operation as compared to broods produced after reservoir operation ( $t = 9.80$ ,  $P < 0.001$ ). Similarly, mean recruitment rates of all wild chinook salmon were also significantly greater for preimpoundment broods as compared to postimpoundment broods ( $t = 11.80$ ,  $P < 0.001$ ).

## Ocean Harvest

Recoveries of Ad-CWT marks indicate that spring chinook salmon from the Rogue River Basin contribute primarily to ocean fisheries in northern California and Oregon (Lewis 1997). Few are landed in Washington, British Columbia, or Alaska. The area between Fort Bragg, California, and Coos Bay, Oregon, accounts for most of the landings of spring chinook salmon from the Rogue River Basin. Commercial trollers accounted for more than 90% of the harvest this area in the 1970s, but the percentage of fish harvested by recreational fisheries increased sharply in the 1990s (PFMC 1998b).

We estimated that the 1974-93 ocean fisheries harvested an average of about 43,000 chinook salmon that originated from the Rogue River upstream of Gold Ray Dam. Annual landings of spring chinook salmon averaged about 28,900 wild fish and about 12,600 hatchery fish. Annual landings of fall chinook salmon averaged about 1,600 wild fish and less than 100 hatchery fish.

Most of the fish were harvested at age 3 or age 4. For wild spring chinook salmon, we estimated that annual harvest averaged 19,245 age 3 fish, 9,341 age 4 fish, 355 age 5 fish, and no age 6 fish (Appendix Table E-28). We estimated that the annual harvest of hatchery spring chinook salmon (mitigation fish only) averaged 9,652 age 3 fish, 2,893 age 4 fish, 69 age 5 fish, and no age 6 fish (Appendix Table E-33). We also estimated that the annual harvest of wild fall chinook salmon averaged 295 age 3 fish, 1,303 age 4 fish, 30 age 5 fish, and 3 age 6 fish (Appendix Table E-39). Age 3 fish composed the majority of the harvest because ocean fisheries probably harvested immature as well as maturing chinook salmon (Van Hyning 1973; Ricker 1980).



## Harvest Rate of Broods

**Ocean Fisheries:** We estimated that the ocean fisheries harvested an average of 45% of the wild and hatchery spring chinook salmon, and 46% of the wild fall chinook salmon, produced by the 1972-89 brood years. Estimates of harvest rates for individual brood years ranged between 11% and 74% for wild spring chinook salmon, 9% and 76% for spring chinook salmon of hatchery origin, and 13% and 73% for wild fall chinook salmon (Appendix Table E-44).

Such high rates of harvest in ocean fisheries are not unusual. For example, Labelle (1997) estimated that harvest rates among four brood years for 14 stocks of coho salmon produced on the east side of Vancouver Island averaged 0.80 annually, while harvest rates were as high as 96% for some stocks in single years.

**All Fisheries:** We estimated that the ocean and freshwater fisheries harvested an average of 52% of the wild spring chinook salmon, 50% of the spring chinook salmon of hatchery origin, and 46% of the wild fall chinook salmon, produced by the 1972-89 brood years. Estimates of harvest rates for individual brood years ranged between 25% and 75% for wild spring chinook salmon, 19% and 77% for spring chinook salmon of hatchery origin, and 25% and 74% for wild fall chinook salmon (Appendix Table E-44).

Harvest rates were greatest on broods produced in the 1970s, and were lowest on broods produced in the 1980s (Figure 45). We believe that three factors were primarily responsible for the decrease in harvest rates. First, increased restrictions to decrease ocean harvest rates for fall chinook salmon produced in the Klamath River Basin origin have also decreased ocean rates for

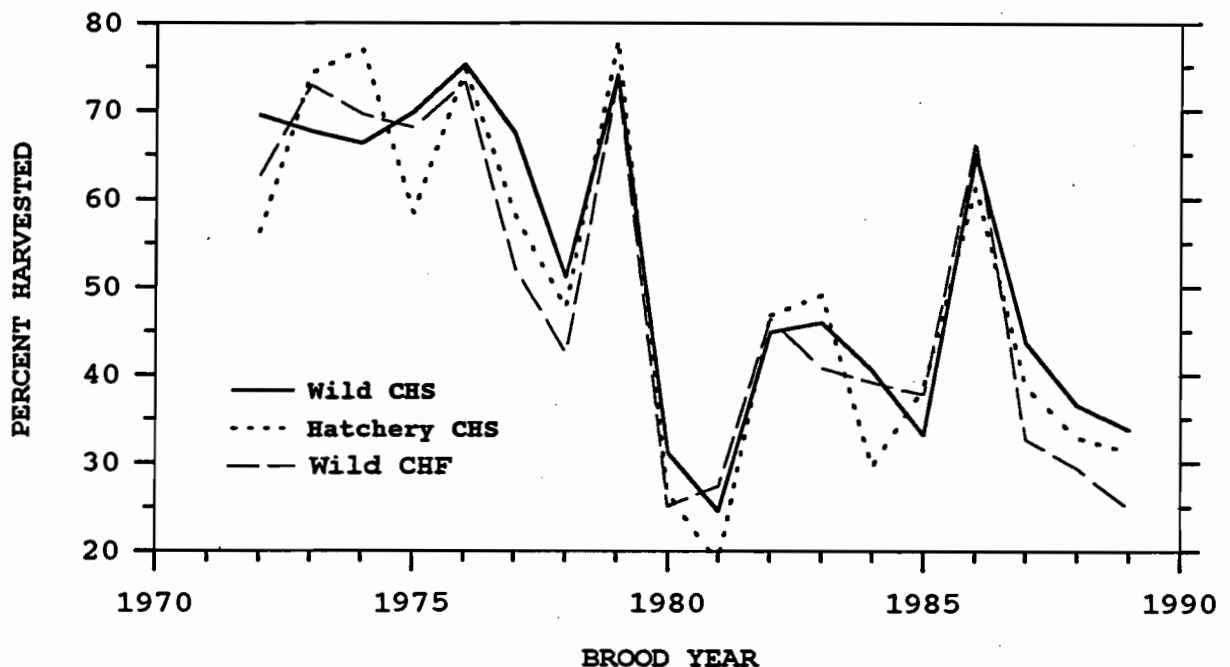

Figure 45. Total harvest rate (%) estimated for completed broods of chinook salmon produced upstream of Gold Ray Dam, 1972-89 brood years. CHS represents spring chinook salmon and CHF represents fall chinook salmon.

chinook salmon of Rogue River origin (see Estimation of Ocean Harvest Rates, page 102). Second, chinook salmon resident in the ocean during the El Niño event of 1982-83 were much smaller than in other years (Appendix Table E-45 and ODFW 1992) and thus a smaller proportion of the brood was available for legal harvest in the ocean fisheries. Finally, chinook salmon of wild and hatchery origin matured at younger ages in the 1980s as compared to the 1970s, decreasing the proportion of the brood that was available for legal harvest in the ocean fisheries.

Brood years produced in the 1970s appeared to be harvested at rates that were close to, or exceeded, optimum yield. Chapman (1986) concluded 68% was an optimum harvest for chinook salmon stocks of British Columbia and Columbia River origin. Reisenbichler (1987) concluded brood harvests of 60-70% are reasonable for many stocks of chinook salmon. Fall chinook salmon of Klamath River Basin origin are managed so that the total harvest rate (ocean and freshwater) does not exceed 67% (PFMC 1998a). With the exception of the 1986 brood year, harvest rates did not exceed 50% for any of the brood years of chinook salmon produced in the Rogue River Basin (Figure 45). These findings suggest that additional regulations to decrease harvest rates would probably not increase the long-term productivity of wild fish.

### Size at Maturity

Fork lengths of wild spring chinook salmon trapped at Gold Ray Dam averaged 41 cm for age 2 fish, 60 cm for age 3 fish, 79 cm for age 4 fish, and 87 cm for age 5 fish. These estimates apply only to those fish that entered the ocean as subyearling migrants (Appendix Table E-45). In addition, data from groups with less than 10 fish were excluded from the summary.

At a given age, fish that entered the ocean as subyearlings were larger at maturity as compared to counterparts that entered the ocean as yearlings. Because reservoir operation was associated with a significant decrease in the relative abundance of yearling smolts (see Age at Ocean Entry, page 86), the remainder of this section applies only the fish that entered the ocean as subyearlings.

We did not detect significant differences, among any of the age classes, of the mean lengths of adults from the 1977-84 brood years as compared to adults from the 1985-89 brood years (all  $P > 0.64$ ). As a result of these findings, we pooled data for the 1977-89 brood years and then compared mean lengths of adults produced before and after reservoir operation.

We found that age 3 fish produced after reservoir operation were an average of 5 cm longer than counterparts produced before reservoir operation (Table 36). In addition, age 4 fish produced after reservoir operation averaged about 4 cm longer than counterparts produced before reservoir operation (Table 36). Age 2 fish produced in preimpoundment years also appeared to be somewhat larger, but age 5 fish produced before and after reservoir operation did not differ in mean lengths (Table 36). An earlier time of ocean entry (see Time of Migration, page 88) was at least partially responsible for the change in size at maturity because chinook salmon grow faster in the ocean than in freshwater.

Table 36. Comparisons of mean lengths of mature wild spring chinook produced as juveniles before and during reservoir operation. Estimates include only those fish that entered the ocean as subyearlings.

	Mean fork length (cm)		P for difference
	1972-76 broods	1977-89 broods	
Age 2	39.2	41.2	0.082
Age 3	56.1	61.3	0.007
Age 4	76.0	79.7	0.019
Age 5	87.4	87.1	0.878

### Size in the Ocean

We indexed the size of wild spring chinook salmon in the ocean by measuring the scale radius from the origin to each ocean annulus for wild spring chinook salmon trapped at Gold Ray Dam. We did not directly estimate the length of fish because our scale analysts believed that there was some scale erosion by the time fish were trapped at Gold Ray Dam. Erosion on scale margins biases estimation of the relationship between fish length and scale radius. Use of such a biased relationship to estimate fish length from scale measurements would have caused fish length to be under-estimated.

**Radius to Annulus One:** We found that the mean scale radius at annulus one differed significantly among brood years of wild spring chinook salmon that entered the ocean as subyearling migrants (Table 37). However, there was no significant difference in mean scale radius at annulus one among fish that matured at different ages (Table 37). Data included in the analysis are in Appendix Table E-46.

Table 37. Comparison of fish length at annulus one for wild age 2-5 spring chinook salmon that entered the ocean as subyearlings, 1972-89 brood years. Lengths were indexed as the mean scale radius (mm at 88x) at annulus one. Brood years with less than 10 samples within any age class were excluded from the analysis.

Analysis of variance					
Source of variation	Sum of squares	df	Mean square	F	P
Age class	315	3	105	1.91	0.143
Brood year	5,205	14	372	6.76	<0.001
Residual	2,310	42	55		

We also found that the mean scale radius at annulus one differed between broods produced in the initial postimpoundment years as compared to the subsequent postimpoundment years. Mean scale radius to annulus one averaged 127.4 mm at 88x for the 1977-84 broods and averaged 117.7 mm at 88x for the 1985-89 broods. A t-test indicated that the means differed significantly ( $t = 2.13$ ,  $P = 0.056$ ). Based on this finding, we chose not to pool data from all postimpoundment broods.

We compared mean scale radius at annulus one among subyearling migrants from broods produced in preimpoundment years, initial postimpoundment years, and subsequent postimpoundment years. A one-way analysis of variance indicated that the means differed significantly ( $F = 5.33$ ,  $P = 0.018$ ) and a Newman-Keuls Multiple Range Test indicated that fish from the initial postimpoundment broods were significantly larger as compared to fish from the preimpoundment broods. The Multiple Range Test also indicated that fish from the subsequent postimpoundment broods did not differ significantly in mean scale radius at annulus one as compared to fish from preimpoundment broods. Data included in the analysis are in Appendix Table E-46.

We hypothesized that the size of fish at annulus one was primarily affected by freshwater growth rate and by ocean physical factors during the period just after smolts entered the ocean. We found that freshwater growth rate, as indexed by the average spacing of freshwater circuli, was positively related to the mean scale radius of subyearling smolts produced by the 1972-89 broods (Figure 46). Residual variation from a regression of scale radius at annulus two on the average spacing of freshwater circuli (Appendix Table E-47) was not significantly related to any indexes of ocean physical factors. A correlation matrix that outlines the relationships among all variables

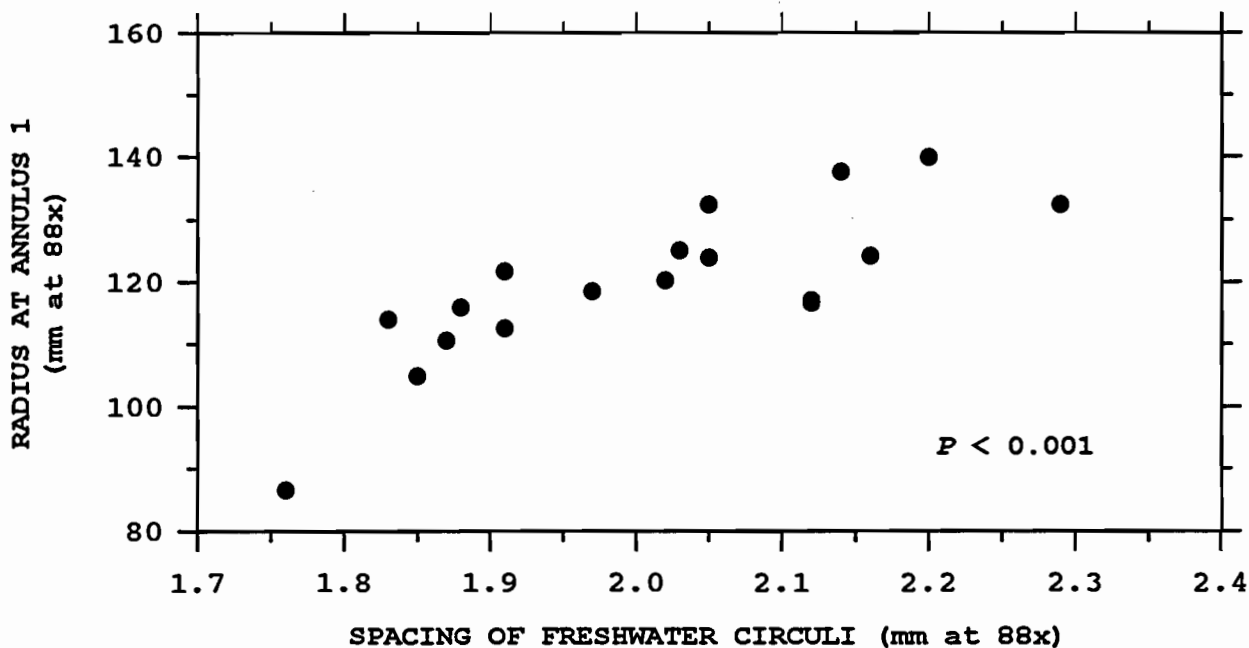

Figure 46. Relationship between the mean scale radius at the first annulus and the mean spacing of freshwater circuli, 1972-89 brood years. Data represent only wild spring chinook salmon that entered the ocean as subyearlings.

examined the regression analysis is in Appendix Table E-48. Data included in the analysis are in Appendix Table E-49.

**Radius to Annulus Two:** We found that the mean scale radius at annulus two differed significantly among brood years for wild spring chinook salmon that matured at ages 3-5 (Table 38). In addition, fish that matured at different ages differed in mean scale radius (Table 38). A Newman-Keuls Multiple Range Test indicated that age 5 fish were significantly larger at annulus two as compared to cohorts that matured at age 3 or age 4. Data included in the analysis are in Appendix Table E-50.

We also found that the mean scale radius at annulus two differed between broods produced in the initial postimpoundment years as compared to the subsequent postimpoundment years. Mean scale radius to annulus two averaged 234.7 mm at 88x for the 1977-84 broods and averaged 211.5 mm at 88x for the 1985-89 broods. A t-test indicated that the means differed significantly ( $t = 2.48, P = 0.031$ ). Based on this finding, we chose not to pool data from all postimpoundment broods.

We then compared mean scale radius at annulus two from broods produced in preimpoundment years, initial postimpoundment years, and subsequent postimpoundment years. A one-way analysis of variance indicated that the means differed significantly ( $F = 4.96, P = 0.022$ ) and a Newman-Keuls Multiple Range Test indicated that fish from the initial postimpoundment broods were significantly larger as compared to fish from the preimpoundment broods and subsequent postimpoundment broods. The Multiple Range Test also indicated that fish from the subsequent postimpoundment broods did not differ significantly in mean scale radius at annulus two as compared to fish from preimpoundment broods. Estimates of mean scale radius at annulus two for fish from the 1972-89 brood years are in Appendix Table E-50.

We hypothesized that the size of fish at annulus two was primarily affected by freshwater growth rate and by ocean physical factors during the period just after formation of the first annulus. We found that the mean

Table 38. Comparison of fish length at annulus two for wild age 3-5 spring chinook salmon that entered the ocean as subyearlings, 1972-89 brood years. Lengths were indexed as the mean scale radius (mm at 88x) at annulus one. Brood years with less than 10 samples within any age class were excluded from the analysis.

Analysis of variance					
Source of variation	Sum of squares	df	Mean square	F	P
Age class	2,819	2	1,410	18.04	<0.001
Brood year	13,091	16	818	10.47	<0.001
Residual	2,500	32	78		

scale radius at the second annulus for fish from the 1972-89 brood years was positively related to the mean scale radius at the first annulus and upwelling in spring, and was negatively related to upwelling in autumn, ocean temperature in autumn, and ocean temperature in winter (Appendix Table E-51). A correlation matrix that outlines the relationships among variables examined the regression analysis is in Appendix Table E-52. Data included in the analysis are in Appendix Table E-53.

**Radius to Annulus Three:** We found that the mean scale radius at annulus three differed significantly among brood years for wild spring chinook salmon that matured at ages 4-5 (Table 39). In addition, mean scale radius at annulus three differed significantly between age 4 and age 5 fish (Table 39), as age 4 fish were larger at the third annulus. Data included in the analysis are in Appendix Table E-54.

We also found that the mean scale radius at annulus three differed between broods produced in the initial postimpoundment years as compared to the subsequent postimpoundment years. Mean scale radius to annulus three averaged 314.2 mm at 88X for the 1977-84 broods and averaged 281.5 mm at 88x for the 1985-89 broods. A t-test indicated that the means differed significantly ( $t = 3.12, P = 0.010$ ). Based on this finding, we chose not to pool data from all postimpoundment broods.

We then compared mean scale radius at annulus three from broods produced in preimpoundment years, initial postimpoundment years, and subsequent postimpoundment years. A one-way analysis of variance indicated that the means differed significantly ( $F = 6.66, P = 0.008$ ) and a Newman-Keuls Multiple Range Test indicated that fish from the initial postimpoundment broods were significantly larger as compared to fish from the preimpoundment broods and subsequent postimpoundment broods. The Multiple Range Test also indicated that fish from the subsequent postimpoundment broods did not differ significantly in mean scale radius at annulus three as compared to fish from preimpoundment broods. Estimates of mean scale radius at annulus three for fish from the 1972-89 brood years are in Appendix Table E-54.

Table 39. Comparison of fish length at annulus three for wild age 4-5 spring chinook salmon that entered the ocean as subyearlings, 1972-89 brood years. Lengths were indexed as the mean scale radius (mm at 88x) at annulus one. Brood years with less than 10 samples within any age class were excluded from the analysis.

Analysis of variance					
Source of variation	Sum of squares	df	Mean square	F	P
Age class	2,850	1	2,850	46.44	<0.001
Brood year	10,652	16	666	10.85	<0.001
Residual	982	16	61		

We hypothesized that the size of fish at annulus three was primarily affected by their size at annulus two and by ocean physical factors during the period just after formation of the second annulus. We found that the mean scale radius at the second annulus for fish from the 1972-89 brood years was positively related to the mean scale radius at the second annulus and upwelling in spring, and was negatively related to ocean temperature in summer and upwelling in autumn (Appendix Table E-55). A correlation matrix that outlines the relationships among all variables examined in the analysis is in Appendix Table E-56. Data included in the analysis are in Appendix Table E-57.

**Discussion:** The size of chinook salmon at annulus formation is affected by growth rate in the ocean, which in turn is dependent on forage availability and water temperature. We found that fish size was correlated to upwelling indexes, which may be related to prey abundance or prey availability. We also found that fish size was correlated to indexes of water temperature in the ocean. Variations in ocean temperature have been associated with variations in the size of sockeye salmon (Cox and Hinch 1997; Hinch et al. 1995).

In addition, we concluded that size at the time when the ocean annuli formed in the previous year was a primary determinant of the size of wild spring chinook salmon in the ocean at the time the second and third annuli formed. We also concluded that freshwater growth rate was a primary determinant of the size of wild spring chinook salmon when the first ocean annulus formed. This finding was commensurate to that of (Nicieza and Braña 1993), who found that the length of Atlantic salmon when the first ocean annulus formed was positively correlated with the estimated length of the smolts at the time of ocean entry.

Because reservoir operation affected freshwater growth rates (see Growth Rate, page 78) of wild juvenile spring chinook salmon, reservoir operation also affected the size of fish in the ocean. Increased freshwater growth rates in the initial postimpoundment years resulted in an earlier time of ocean entry, which resulted in greater ocean growth and a larger size when the ocean annuli formed. As we will show in the succeeding section, size at the time of annulus formation appeared to be a primary factor that affected the maturation rates of wild spring chinook salmon.

## **Maturity Rates**

Scale analyses indicated that wild and hatchery spring chinook salmon, and wild and hatchery fall chinook salmon, of Rogue River origin matured at ages 2-6. Tag returns from Ad-CWT marked fish indicated that spring chinook salmon of hatchery origin also matured at ages 2-6.

**Wild Spring Chinook Salmon:** Estimates of maturity probabilities for wild spring chinook salmon from the 1972-89 brood years averaged 0.019 for age 2 fish, 0.086 for age 3 fish, 0.500 for age 4 fish, and 0.918 for age 5 fish. Data included in these summaries, and in the succeeding analyses, are in Appendix Table E-58.

Maturity rates of wild spring chinook salmon did not differ significantly for broods produced in the initial postimpoundment years as compared to the subsequent postimpoundment years (Table 40). These findings suggested that

Table 40. Comparisons of maturity rates at each age for wild spring chinook salmon from the 1977-84 broods and the 1985-89 broods. Data were arcsin transformed prior to testing with a one-way analysis of variance.

	<u>Mean probability of maturation</u>		<i>P</i> for difference	Detectable change <sup>a</sup>
	1977-84 broods	1985-89 broods		
Age 2	0.028	0.033	0.885	< 0.007 or > 0.057
Age 3	0.103	0.118	0.973	< 0.041 or > 0.173
Age 4	0.636	0.522	0.267	< 0.502 or > 0.753
Age 5	0.974	0.928	0.406	< 0.947 or > 0.999

<sup>a</sup> From the mean of the 1977-84 brood years.

the release of colder water from the reservoir in the late spring and early summer of 1986-1990 was not associated with any significant changes in the maturity rates of wild spring chinook salmon produced in postimpoundment years. However, sensitivity analyses indicated that any changes in maturity rates would have had to been great to have been detected by parametric statistics (Table 40). Lack of significant changes led us to pool estimates of maturation rates for all broods produced in postimpoundment years.

We found that wild spring chinook salmon produced after the operation of Lost Creek Dam matured at younger ages as compared to those of counterparts produced after reservoir operation (Table 41). The change in maturity rates was most pronounced for wild fish at age 4, but maturity rates appeared to have increased at each of the four ages (Table 41). These findings indicated that wild spring chinook salmon produced in the upper river matured at younger ages after the operation of Lost Creek Dam.

We hypothesized that the probability of maturity at each age was primarily affected by fish size and ocean physical factors during the year before partial maturation of the cohort. Mean scale radius at formation of each annulus was used as an index of fish size. We used indexes of water temperature and upwelling to characterize ocean conditions in the area

Table 41. Comparisons of maturity rates at each age for wild spring chinook salmon produced before and during reservoir operation. Medians were compared with a Kruskal-Wallis analysis of variance by ranks.

	<u>Median probability of maturation</u>		<i>P</i> for difference
	1969-76 broods	1977-89 broods	
Age 2	0.010	0.023	0.051
Age 3	0.050	0.086	0.083
Age 4	0.319	0.635	0.002
Age 5	0.924	1.000	0.059



proximal to the mouth of the Rogue River and estimated mean values for summer (June–August), autumn (September–November), winter (December–February), and spring (March–May). A correlation matrix that outlines the relationships among the various indexes of ocean physical factors is in Appendix Table E-59. Physical factor data that were included in the analyses are presented in Appendix Table E-60.

We found that fish size was positively related to the maturity rates of wild spring chinook salmon at age 2, age 3, and age 4 (Table 42). Greater proportions of the broods matured and returned to freshwater when fish were larger in the ocean at the time of annulus formation. We also found significant relationships between maturity rates and ocean physical factors (Table 42). Negative regression coefficients suggested that smaller proportions of the cohorts tended to mature under conditions of greater upwelling and warmer water temperatures in the ocean (Table 42). Correlation matrices that outline the relationships between factors examined in the regression analyses are in Appendix Tables E-61 and E-62.

**Spring Chinook Salmon of Hatchery Origin:** Estimates of maturity probabilities for spring chinook salmon of hatchery origin from the 1972–89 brood years averaged 0.019 for age 2 fish, 0.086 for age 3 fish, 0.555 for age 4 fish, and 0.933 for age 5 fish. These estimates apply to all (marked and unmarked) fish released from Cole M. Rivers Hatchery after 1 August. Data included in these summaries are in Appendix Table E-58.

Table 42. Summary of regression analyses for factors related to the maturity rates of wild age 2–5 spring chinook salmon. Maturity rates were transformed to logits prior to analysis. Data are described in Appendix Tables E-46, E-50, E-54, E-58, and E-60.

Dependent variable	$r^2$	Independent variable	Regression coefficient	Standard error	$P$
Maturity rate at age 2	0.20	Radius at annulus 1 Constant	$4.479 \times 10^{-2}$ -9.493	$2.423 \times 10^{-2}$	0.042
Maturity rate at age 3	0.51	Radius at annulus 2 Spring upwelling Spring temperature Constant	$2.588 \times 10^{-2}$ $-5.368 \times 10^{-3}$ $-3.946 \times 10^{-1}$ -3.467	$0.949 \times 10^{-2}$ $2.354 \times 10^{-3}$ $1.982 \times 10^{-1}$	0.017 0.040 0.068
Maturity rate at age 4	0.55	Radius at annulus 3 Spring upwelling Summer temperature Constant	$1.768 \times 10^{-2}$ $-4.293 \times 10^{-3}$ $-5.022 \times 10^{-1}$ 1.289	$0.679 \times 10^{-2}$ $1.852 \times 10^{-3}$ $2.467 \times 10^{-1}$	0.021 0.036 0.061
Maturity rate at age 5	0.42	Summer upwelling Autumn temperature Constant	$-9.451 \times 10^{-3}$ $-9.736 \times 10^{-1}$ 17.811	$3.129 \times 10^{-3}$ $4.679 \times 10^{-1}$	0.008 0.053

We hypothesized that the probability of maturity at each age was primarily affected by time at release, fish size at release, and ocean physical factors during the period before partial maturation of the cohort. Unlike wild fish, we could not index fish size as we did not measure scales of hatchery fish.

We found that date of release was negatively related to the maturity rates of hatchery fish at age 2, age 3, and age 4 (Table 43). Greater proportions of the broods matured and returned to freshwater when fish were released from the hatchery at earlier dates. We also found significant relationships between maturity rates and ocean physical factors (Table 43). In contrast to findings for wild fish, regression coefficients for ocean physical factors were both positive and negative (Table 43). We did not evaluate factors related to maturity rates at age 5 because all hatchery fish in matured at age 5 except for fish within five brood years (Appendix Table E-58). A correlation matrix that outlines the relationships among the variables examined in the analyses are in Appendix Table E-63.

In addition, we evaluated factors related to maturity rates of Ad-CWT marked spring chinook salmon. Results from these analyses also indicated that maturity rates of hatchery fish were negatively related to date of release, and were positively related to fish weight at time of release (Table 44). The positive relationship between smolt size and maturity rate indicated that smolts released at larger sizes tended to mature at younger ages. When ocean factors were significantly related to maturity rates, the regression coefficients were mostly negative (Table 44). These results suggested that fish matured at younger ages during periods of greater upwelling and ocean temperatures. A correlation matrix that outlines the relationships among variables examined in the analyses is in Appendix Table E-64.

Table 43. Summary of regression analyses for factors related to the maturity rates of age 2-4 spring chinook salmon of hatchery origin. Maturation rates were transformed to logits prior to analysis. Data are described in Appendix Tables E-58 and E-60.

Dependent variable	r <sup>2</sup>	Independent variable	Regression coefficient	Standard error	P
Maturity rate at age 2	0.40	Release date	-1.620 x 10 <sup>-2</sup>	0.642 x 10 <sup>-2</sup>	0.024
		Spring temperature	8.300 x 10 <sup>-1</sup>	4.132 x 10 <sup>-1</sup>	0.064
		Constant	-8.768		
Maturity rate at age 3	0.48	Release date	-1.980 x 10 <sup>-2</sup>	0.556 x 10 <sup>-2</sup>	0.003
		Winter temperature	6.231 x 10 <sup>-1</sup>	3.072 x 10 <sup>-1</sup>	0.061
		Constant	-3.123		
Maturity rate at age 4	0.75	Release date	-1.250 x 10 <sup>-2</sup>	0.242 x 10 <sup>-2</sup>	<0.001
		Summer temperature	-1.230	0.243	<0.001
		Autumn temperature	7.076 x 10 <sup>-1</sup>	2.093 x 10 <sup>-1</sup>	0.004
		Spring temperature	-3.337 x 10 <sup>-1</sup>	1.368 x 10 <sup>-1</sup>	0.028
		Constant	14.447		

Table 44. Summary of regression analyses for factors related to the maturity rates of Ad-CWT marked spring chinook salmon at ages 2-4. Maturity rates were transformed to logits prior to analysis. Data are described in Appendix Tables E-58 and E-60.

Dependent variable	r <sup>2</sup>	Independent variable	Regression coefficient	Standard error	P
Maturity rate at age 2 <sup>a</sup>	0.71	Release date	-2.552 x 10 <sup>-2</sup>	0.188 x 10 <sup>-2</sup>	<0.001
		Release weight	3.051 x 10 <sup>-2</sup>	0.467 x 10 <sup>-2</sup>	<0.001
		Summer upwelling	-2.030 x 10 <sup>-3</sup>	0.887 x 10 <sup>-3</sup>	0.024
		Summer temperature	2.717 x 10 <sup>-1</sup>	1.238 x 10 <sup>-1</sup>	0.030
		Constant	-1.627		
Maturity rate at age 3 <sup>b</sup>	0.73	Release weight	-1.723 x 10 <sup>-2</sup>	0.328 x 10 <sup>-2</sup>	<0.001
		Winter upwelling	-6.511 x 10 <sup>-3</sup>	0.614 x 10 <sup>-3</sup>	<0.001
		Spring upwelling	-1.118 x 10 <sup>-2</sup>	0.117 x 10 <sup>-2</sup>	<0.001
		Autumn temperature	7.912 x 10 <sup>-1</sup>	0.917 x 10 <sup>-1</sup>	<0.001
		Spring temperature	-2.218	0.164	<0.001
Constant	13.009				
Maturity rate at age 4 <sup>c</sup>	0.53	Release date	-6.687 x 10 <sup>-3</sup>	2.209 x 10 <sup>-3</sup>	0.003
		Autumn upwelling	-1.492 x 10 <sup>-1</sup>	0.373 x 10 <sup>-3</sup>	<0.001
		Winter upwelling	-5.140 x 10 <sup>-3</sup>	0.786 x 10 <sup>-2</sup>	<0.001
		Autumn temperature	-1.336	0.222	<0.001
		Winter temperature	-9.752 x 10 <sup>-1</sup>	1.873 x 10 <sup>-1</sup>	<0.001
Constant	27.753				

<sup>a</sup> Data excluded for groups with less than 400 fish estimated to be alive in the ocean at age 2 and for the 1980 brood year.

<sup>b</sup> Data excluded for groups with less than 200 fish estimated to be alive in the ocean at age 3 and for the 1979 brood year.

<sup>c</sup> Data excluded for groups with less than 50 fish estimated to be alive in the ocean at age 4.

**Wild Fall Chinook Salmon:** Estimates of maturity probabilities for wild fall chinook salmon from the 1981-89 brood years averaged 0.073 for age 2 fish, 0.175 for age 3 fish, 0.680 for age 4 fish, and 0.934 for age 5 fish. Data included in these summaries, and in the succeeding analyses, are in Appendix Table E-65.

We found that wild fall chinook salmon matured at a younger age than did wild spring chinook salmon. Differences in maturation rates were most evident at age 2, but there also appeared to be a tendency for greater proportions of fall chinook salmon to mature at ages 3 and 4 (Table 45). Fall chinook salmon may have matured at younger ages than spring chinook salmon because they reared farther downstream where water temperatures in summer were closer to optimum for juvenile growth (see Growth Rate, page 78).

We did not compare maturity rates of fall chinook salmon produced before and after operation of Lost Creek Dam because we did not sample to estimate

Table 45. Comparisons of maturity rates at each age for wild fall chinook salmon and wild spring chinook salmon, 1981-89 brood years. Data were arcsin transformed prior to testing with a paired t-test.

	Mean probability of maturation		P for difference
	Fall race	Spring race	
Age 2	0.073	0.035	0.007
Age 3	0.175	0.133	0.093
Age 4	0.680	0.590	0.075
Age 5	0.934	0.953	0.918

the age composition of fall chinook salmon until 1986. We also did not evaluate factors that may have affected maturity rates of fall chinook salmon because only 6-8 brood years would have composed the analyses.

**All Wild Chinook Salmon:** Estimates of maturity probabilities for wild chinook salmon from the 1972-89 brood years averaged 0.033 for age 2 fish, 0.104 for age 3 fish, 0.517 for age 4 fish, and 0.921 for age 5 fish. Data included in these summaries, and in the succeeding analyses, are in Appendix Table E-66.

Maturity rates did not differ significantly for broods of wild fish produced in the initial postimpoundment years as compared to the subsequent postimpoundment years (Table 46). This finding suggested that the release of colder water from the reservoir in the late spring and early summer of 1986-1990 was not associated with any changes in the maturity rates of wild chinook salmon produced in postimpoundment years. However, sensitivity analyses indicated that any changes in maturity rates would have had to been great to have been detected by parametric statistics (Table 46). Lack of significant changes led us to pool estimates of maturation rates for all broods produced in postimpoundment years.

Table 46. Comparisons of maturity rates at each age for all wild chinook salmon from the 1977-84 broods and the 1985-89 broods. Data were arcsin transformed prior to testing with a one-way analysis of variance.

	Mean probability of maturation		P for difference	Detectable change <sup>a</sup>
	1977-84 broods	1985-89 broods		
Age 2	0.038	0.045	0.689	< 0.013 or > 0.068
Age 3	0.132	0.128	0.746	< 0.070 or > 0.203
Age 4	0.654	0.548	0.265	< 0.545 or > 0.777
Age 5	0.973	0.917	0.201	< 0.948 or > 0.999

<sup>a</sup> From the mean of the 1977-84 brood years.

We found that wild chinook salmon produced after the operation of Lost Creek Dam matured at younger ages as compared to those of counterparts produced after reservoir operation (Table 47). The change in maturity rates was most pronounced for wild fish at age 4, but the probability of maturation increased significantly at each of the four ages (Table 47). These findings indicate that wild chinook salmon produced in the upper river matured at younger ages after the operation of Lost Creek Dam.

We hypothesized that the probability of maturity at each age was primarily affected by time at release, fish size at release, and ocean physical factors during the period before partial maturation of the cohort. As with wild spring chinook salmon, we found that maturity rates of all wild chinook salmon at age 2, age 3, and age 4 were positively related to fish size when the last saltwater annulus formed and were negatively related to various indexes of ocean physical factors (Table 48). A correlation matrix that outlines the relationships among variables examined in the analyses are in Appendix Table E-67.

We noted only one disparity in the results of regression analyses for wild spring chinook salmon and all wild chinook salmon. We could account for only 20% of the variation in maturity rates of wild spring chinook salmon at age 2, but were able to account for 62% of the variation in maturity rates of all wild chinook salmon at age 2. The difference may have resulted from classification of fish that passed Gold Ray Dam. Age 2 spring chinook salmon passed Gold Ray Dam later than older spring chinook salmon (see Migration Timing, page 157) and any migration delays were more likely to cause age 2 spring chinook salmon to be classified as fall chinook salmon.

**Discussion:** Age at maturity varies greatly among populations of chinook salmon. In general, age at maturity increases with increasing latitude (Healey and Heard 1984; Hankin and Healey 1986). An older age at maturity may be a genetic adaptation to slower rates of freshwater growth at higher latitudes (Roff 1984). Our estimates of maturity rates for wild spring chinook salmon produced before reservoir operation approximate maturity rates of a mid-maturing stock as defined by Hankin and Healey (1986), while maturity rates of wild fish produced after reservoir operation more closely approximate maturity rates of an early-maturing stock.

Table 47. Comparisons of maturity rates at each age for all wild chinook salmon produced before and after the operation of Lost Creek Dam. Medians were compared with a Kruskal-Wallis analysis of variance by ranks.

	<u>Median probability of maturation</u>		<i>P</i> for difference
	1969-76 broods	1977-89 broods	
Age 2	0.014	0.036	0.031
Age 3	0.055	0.115	0.004
Age 4	0.330	0.651	<0.001
Age 5	0.924	0.981	0.034

Table 48. Summary of regression analyses for factors related to the maturity rates of all wild age 2-5 chinook salmon. Maturity rates were transformed to logits prior to analysis. Data are described in Appendix Tables E-46, E-50, E-54, E-58, and E-66.

Dependent variable	r <sup>2</sup>	Independent variable	Regression coefficient	Standard error	P
Maturity rate at age 2	0.62	Radius at annulus 1	$3.006 \times 10^{-2}$	$1.030 \times 10^{-2}$	0.012
		Summer upwelling	$-4.356 \times 10^{-3}$	$1.356 \times 10^{-3}$	0.007
		Summer temperature	$-6.372 \times 10^{-1}$	$2.435 \times 10^{-1}$	0.021
		Constant	1.932		
Maturity rate at age 3	0.49	Radius at annulus 2	$1.944 \times 10^{-2}$	$0.822 \times 10^{-2}$	0.033
		Spring upwelling	$-4.638 \times 10^{-3}$	$1.944 \times 10^{-3}$	0.032
		Constant	-6.185		
Maturity rate at age 4	0.56	Radius at annulus 3	$1.440 \times 10^{-2}$	$0.673 \times 10^{-2}$	0.050
		Summer upwelling	$-3.908 \times 10^{-3}$	$1.589 \times 10^{-3}$	0.028
		Summer temperature	$-7.940 \times 10^{-1}$	$2.501 \times 10^{-1}$	0.007
		Constant	6.799		
Maturity rate at age 5	0.30	Summer upwelling	$-7.906 \times 10^{-3}$	$2.974 \times 10^{-3}$	0.017
		Autumn temperature	$-1.005 \times 10^{-1}$	$4.447 \times 10^{-1}$	0.037
		Constant	17.611		

Findings from our analyses of maturity rates of wild and hatchery chinook salmon seem to be consistent. The size of immature fish in the ocean appeared to affect maturity rates of wild fish, while release date and smolt size appeared to affect maturity rates of hatchery fish. Hatchery fish released at earlier dates and at larger sizes were probably larger at the time the first annulus formed in the ocean, because chinook salmon grow faster in the ocean than in freshwater.

Results from other research showed that heredity and growth rate affect maturation rate of chinook salmon. Maturity age of progeny appears strongly influenced by parental age (Donaldson and Menasveta 1961; Beacham et al. 1989; Hankin et al. 1993), but changes in growth rate can change maturation rates of chinook salmon. Neilson and Geen (1986) found a negative correlation between length at time of first annulus formation and age at maturity for male chinook salmon from the Sixes River in Oregon. The tendency for faster growing chinook salmon to mature at younger ages was also noted by Parker and Larkin (1959) and by Schluchter and Lichatowich (1977). Similar findings have also been reported for Atlantic salmon (Friedland et al. 1996; Friedland and Haas 1996).

Release strategies for hatchery fish also affect maturation rates of chinook salmon. Bilton (1984) found a negative correlation between mean weight of juvenile chinook salmon at time of hatchery release and mean age of returning adults. Hankin (1990) found that release date affected maturity

rates of Ad-CWT marked chinook salmon released from hatcheries in northern California and southern Oregon, but concluded that weight at release had minimal affect on maturity rates as compared to release date. Male chinook salmon of hatchery origin matured at higher rates at age 2 and age 3 compared with wild counterparts and there was some evidence that natural spawning by hatchery fish was associated with a change in the maturation rates of wild males (Unwin and Glova 1997).

We concluded that the operation of Lost Creek Dam affected maturity rates of wild spring chinook salmon produced in the Rogue River. Broods produced after reservoir operation probably matured at younger ages because juveniles grew faster in fresh water (see Growth Rate, page 78), entered the ocean earlier (see Time of Ocean Entry:, page 89), and were larger when saltwater annuli formed (see Size in the Ocean, page 134).

While releases of cold hypolimnetic storage during late spring and early summer were effective in reducing the freshwater growth rates of wild juvenile spring chinook salmon, the change in growth rates did not result in any detectable changes in maturity rates within the population. This finding indicates that the limited supply of cold water stored in the reservoir would be more effectively used if released for fishery purposes other than attempting to restore maturity rates of wild spring chinook salmon.

We also concluded that, although a younger age at maturity increases the number of adult fish that return to freshwater, the number of fish harvested in the ocean and in freshwater fisheries decreases, as does the proportion of older fish among spawners (see Age Composition, page 146).

The decrease in the age of spawners may be of particular concern to fishery managers. Older female salmonids of larger sizes tend to excavate deeper redds as compared to younger (smaller) counterparts (DeVries 1997). Among coho salmon, van den Berghe and Gross (1984) found that females 75 cm in length excavated redds that were about 20 cm deep, while females 45 cm long excavated redds that were about 10 cm deep. If female spring chinook salmon in the Rogue River matured at younger ages, as suggested by our findings, then the resultant eggs and alevins would be more susceptible to loss during floods (see Abundance, page 67).

In addition, larger female salmon produce more eggs, and larger eggs, (Healey and Heard 1984) and can spawn in a wider array of locations in streams (Fleming and Gross 1994). These factors affect recruitment rates and a reduction in the proportion of older age classes has the potential to reduce production in populations of Pacific salmon (Forbes and Peterman 1994).

### Age Composition

We concluded that the age composition of fish trapped at Gold Ray Dam did not accurately reflect the age composition of chinook salmon that originated the area farther upstream. Age-selective harvest in the ocean fisheries (see Estimation of Ocean Harvest Rates, page 102) and in the fishery for spring chinook salmon in the lower river (see Fishery Selectivity, page 198) decreased the relative abundance of older adults among fish trapped at Gold Ray Dam. In addition, mortality rates increased for chinook salmon

the ocean during 1982-83 (see Effects of the El Niño event of 1982-83:, page 125). We attempted to account for these factors and estimated the age composition of freshwater returns as if there had been no harvest related mortality and no El Niño event of 1982-83.

Older age classes would have been more dominant among the freshwater returns of chinook salmon without age selective mortality. For example, annual trap catches of wild spring chinook salmon from the 1972-89 brood years averaged 16% age 5 fish, but would have averaged of 33% age 5 fish without age selective mortality. Because mortality rates that resulted from the fisheries in the ocean and in the lower river varied greatly between years, we limited the analyses of age composition to only those estimates adjusted for age selective mortality.

**Wild Spring Chinook Salmon:** Adjustments for age selective mortality that resulted from harvest and the El Niño event of 1982-83 indicated that the age composition of wild fish during freshwater entry would have averaged 6% age 2 fish, 11% age 3 fish, 46% age 4 fish, 33% age 5 fish, and 3% age 6 fish for the 1972-89 brood years. Estimates of age composition adjusted for age selective mortality among wild spring chinook salmon are in Appendix Table E-68.

The age composition of wild fish did not differ significantly for brood years produced in the initial postimpoundment years as compared to the subsequent postimpoundment years (Table 49). This finding suggested that the release of colder water from the reservoir in late spring and early summer of 1986-1990 was not associated with any changes in the age composition of wild spring chinook salmon produced in postimpoundment years. However, sensitivity analyses indicated that any changes in age composition would have had to been great to have been detected by parametric statistics (Table 49). Lack of significant changes led us to pool estimates of age composition for all brood years of wild fish produced after the operation of Lost Creek Dam.

Table 49. Estimated age composition of wild spring chinook salmon produced by the 1977-84 brood years as compared to the 1985-89 brood years. Estimates represent projected returns to freshwater without age selective mortality that resulted from fisheries or the El Niño event of 1982-83. Data were arcsin transformed prior to testing with a one-way analysis of variance.

	Mean proportion of production		P for difference	Detectable change <sup>b</sup>
	1977-84 broods <sup>a</sup>	1985-89 broods		
Age 2	0.074	0.079	0.987	< 0.003 or > 0.124
Age 3	0.119	0.131	0.964	< 0.053 or > 0.194
Age 4	0.529	0.438	0.251	< 0.428 or > 0.627
Age 5	0.241	0.326	0.313	< 0.142 or > 0.334
Age 5	0.005	0.027	0.139	< 0.001 or > 0.031

<sup>a</sup> Estimates affected by the El Niño event of 1982-83 were excluded.

<sup>b</sup> From the mean of the 1977-84 brood years.



We found that the age composition of wild spring chinook salmon changed after the operation of Lost Creek Dam. Age 5 and age 6 fish were more prevalent among preimpoundment brood years than among postimpoundment brood years (Table 50). In contrast, age 2, age 3, and age 4 fish were more prevalent among postimpoundment brood years than among preimpoundment brood years (Table 50). These findings, in conjunction with findings from the analyses of maturity rates, indicated that wild spring chinook salmon matured at younger ages after the construction and operation of Lost Creek Dam.

Table 50. Estimated age composition of wild spring chinook salmon produced by the 1972-76 brood years as compared to the 1977-89 brood years. Estimates represent projected returns to freshwater without age selective mortality that resulted from fisheries or the El Niño event of 1982-83. Data were arcsin transformed prior to testing with a one-way analysis of variance.

	Mean proportion of production		P for difference
	1972-76 broods	1977-89 broods <sup>a</sup>	
Age 2	0.029	0.076	0.034
Age 3	0.062	0.124	0.166
Age 4	0.362	0.494	0.049
Age 5	0.467	0.273	0.013
Age 6	0.080	0.014	0.006

<sup>a</sup> Estimates affected by the El Niño event of 1982-83 were excluded.

We hypothesized that the age composition of wild spring chinook salmon was primarily affected by fish size after the first year of life and by ocean physical factors after smolts entered the ocean. Mean scale radius at formation of annulus 1 (Appendix Table E-46) was used as an index of fish size after the first year of life. Physical factor data included in the analyses are in Appendix Table E-60. A correlation matrix that outlines the relationships among the indexes of ocean physical factors is in Appendix Table E-59. We did not analyze factors related to the proportion of age 2 fish among completed brood years because the analysis would produce the same results as the analysis of the probability of maturity at age 2 (see Maturity Rates, page 138).

We found that the percentage of age 3 fish produced among the 1972-89 broods was positively related to fish size at annulus 1 and ocean physical parameters in autumn after smolts entered the ocean (Table 51). This finding indicated that the relative abundance of age 3 fish increased when fish were larger at the time of formation of the first annulus. We also found that the percentage of age 5 fish produced among the 1972-89 broods was negatively related to fish size at annulus 1 and ocean physical parameters after smolts entered the ocean (Table 51). This finding indicated that the relative abundance of age 5 fish decreased when fish were larger at the time of formation of the first annulus. In contrast to age 3 and age 5 fish, the size of fish when annulus 1 formed was not related to the percentage of age 4 fish within completed broods (Table 51).

Table 51. Summary of regression analyses for factors related to the age composition (% of each brood year) of wild spring chinook salmon. Percentages were transformed to logits prior to analysis. Data are described in Appendix Tables E-46, E-60, and E-68.

Dependent variable	$r^2$	Independent variable	Regression coefficient	Standard error	$P$
% Age 3	0.80	Radius at annulus 1	$3.145 \times 10^{-2}$	$0.707 \times 10^{-2}$	<0.001
		Autumn upwelling	$-1.653 \times 10^{-2}$	$0.248 \times 10^{-2}$	<0.001
		Autumn temperature	-1.152	0.187	<0.001
		Constant	7.568		
% Age 4	0.33	Spring upwelling	$-4.516 \times 10^{-3}$	$1.486 \times 10^{-3}$	0.008
		Constant	0.254		
% Age 5	0.74	Radius at annulus 1	$-2.423 \times 10^{-2}$	$0.835 \times 10^{-2}$	0.013
		Summer upwelling	$2.964 \times 10^{-3}$	$1.037 \times 10^{-3}$	0.014
		Autumn upwelling	$7.944 \times 10^{-3}$	$3.112 \times 10^{-3}$	0.025
		Autumn temperature	$6.810 \times 10^{-1}$	$2.141 \times 10^{-1}$	0.008
		Winter temperature	$-3.712 \times 10^{-1}$	$1.457 \times 10^{-1}$	0.026
		Constant	-3.163		

**Spring Chinook Salmon of Hatchery Origin:** Adjustments for age selective mortality that resulted from harvest and the El Niño event of 1982-83 indicated that the age composition of hatchery fish (mitigation fish only) at the time of freshwater entry would have averaged 4% age 2 fish, 11% age 3 fish, 51% age 4 fish, 30% age 5 fish, and 3% age 6 fish for the 1984-89 brood years. Data included in these summaries are in Appendix Table E-68.

We estimated the age composition of hatchery fish by the analysis of scales taken from marked and unmarked fish trapped at Gold Ray Dam. To evaluate the reliability of these estimates, we compared the age composition estimates developed from trapped fish with estimates developed from recoveries of Ad-CWT marked fish (Appendix Table E-69). Results indicated that there was a greater proportion of age 4 fish among the Ad-CWT marked fish as compared to the trap catches (Table 52). However, because the difference between the two groups was relatively small (0.53 for trapped fish and 0.61 for Ad-CWT marked fish), and because there were no significant differences among the other age groups (Table 52), we concluded that scale analyses resulted in reasonable estimates of age composition for all spring chinook salmon of hatchery origin.

We hypothesized that the age composition of spring chinook salmon of hatchery origin was primarily affected by the date of release, size at release, and by ocean physical factors after smolts entered the ocean. Physical factor data included in the analyses are in Appendix Table E-60. A correlation matrix that outlines the relationships among the indexes of ocean physical factors is in Appendix Table E-59. We did not analyze factors related to the proportion of age 2 fish among completed brood years because the analysis would produce the same results as the analysis of the probability of maturity at age 2 (see Maturity Rates, page 138).

Table 52. Estimated age composition of spring chinook salmon identified as hatchery fish after capture at Gold Ray Dam as compared to Ad-CWT marked counterparts released in September and October, 1974-89 brood years. Estimates represent projected returns to freshwater without age selective mortality that resulted from fisheries or the El Niño event of 1982-83. Data were arcsin transformed prior to testing with a paired t-test.

	Mean proportion of production		P for difference
	Trap catch	Ad-CWT marks	
Age 2	0.052	0.033	0.272
Age 3	0.122	0.105	0.281
Age 4	0.532	0.611	0.056
Age 5	0.254	0.241	0.663
Age 6	0.042	0.007	0.269

We found that the percentage of age 3 fish produced among the 1972-89 broods was negatively related to the release date and upwelling in autumn after smolts entered the ocean (Table 53). This finding indicated that the relative abundance of age 3 fish increased when smolts were released at earlier dates from the hatchery. We also found that the percentage of age 5 fish produced among the 1972-89 broods was positively related to the release date and upwelling in autumn after smolts entered the ocean (Table 53). This finding indicated that the relative abundance of age 5 fish decreased when smolts were released on earlier dates. In contrast to age 3 and age 5 fish, the percentage of age 4 fish within completed broods was not significantly related to the date fish were released from the hatchery (Table 53).

Table 53. Summary of regression analyses for factors related to the age composition (% of each brood year) of spring chinook salmon of hatchery origin. Percentages were transformed to logits prior to analysis. Data are described in Appendix Tables E-60 and E-68.

Dependent variable	r <sup>2</sup>	Independent variable	Regression coefficient	Standard error	P
% Age 3	0.37	Release date	$-9.571 \times 10^{-3}$	$4.202 \times 10^{-3}$	0.038
		Autumn upwelling	$-6.483 \times 10^{-3}$	$3.447 \times 10^{-3}$	0.060
		Constant	0.526		
% Age 4	0.41	Spring upwelling	$-5.508 \times 10^{-3}$	$1.544 \times 10^{-3}$	0.003
		Constant	0.588		
% Age 5	0.51	Release date	$1.130 \times 10^{-2}$	$0.371 \times 10^{-2}$	0.008
		Autumn upwelling	$3.159 \times 10^{-3}$	$0.956 \times 10^{-3}$	0.005
		Constant	-3.835		

**Wild Fall Chinook Salmon:** Adjustments for age selective mortality that resulted from harvest indicated that the age composition of wild fish at the time of freshwater entry would have averaged 22% age 2 fish, 20% age 3 fish, 41% age 4 fish, 14% age 5 fish, and 2% age 6 fish for the 1984-89 brood years. Estimates of age composition adjusted for age selective mortality among wild fall chinook salmon are in Appendix Table E-70.

We found that wild fall chinook salmon matured at a younger age than did wild spring chinook salmon. Age 2 and age 3 fish were more prevalent among wild fall chinook salmon while age 5 fish were more prevalent among wild spring chinook salmon (Table 54). These findings indicated that the two races matured at different rates. Fall chinook salmon may have matured a younger ages than spring chinook salmon because they reared farther downstream where water temperatures in summer were closer to optimum for juvenile growth (see *Growth Rate*, page 78). We did not compare the age composition of wild fall chinook salmon produced before and after operation of Lost Creek Dam because we did not begin sampling scales from fall chinook salmon until 1986.

Table 54. Age composition of wild fall chinook salmon and wild spring chinook salmon produced by the 1984-89 brood years. Estimates represent predicted freshwater returns without age selective mortality that resulted from harvest. Data were arcsin transformed prior to testing with a paired t-test.

	Mean proportion of production		P for difference
	Fall race	Spring race	
Age 2	0.224	0.084	<0.001
Age 3	0.204	0.135	0.079
Age 4	0.405	0.464	0.261
Age 5	0.142	0.292	0.004
Age 6	0.024	0.024	1.000

**All Wild Chinook Salmon:** Adjustments for age selective mortality that resulted from harvest and the El Niño event of 1982-83 indicated that the age composition of wild fish at the time of freshwater entry would have averaged 9% age 2 fish, 13% age 3 fish, 44% age 4 fish, 29% age 5 fish, and 3% age 6 fish for the 1972-89 brood years. Estimates of age composition adjusted for age selective mortality among all chinook salmon are in Appendix Table E-71.

The age composition of wild fish did not differ significantly for brood years produced in the initial postimpoundment years as compared to the subsequent postimpoundment years, except for age 6 fish (Table 55). This finding suggested that the release of colder water from the reservoir in the late spring and early summer of 1986-1990 was not associated with any change in the age composition of wild chinook salmon produced in postimpoundment years. However, sensitivity analyses indicated that other changes in age composition would have had to been great to have been detected by parametric statistics (Table 55). Lack of significant changes, except for age 6 fish, led us to pool estimates of age composition for all brood years of wild fish produced after the operation of Lost Creek Dam.

Table 55. Estimated age composition of all wild chinook salmon produced by the 1977-84 brood years as compared to the 1985-89 brood years. Estimates represent projected returns to freshwater without age selective mortality that resulted from fisheries or the El Niño event of 1982-83. Data were arcsin transformed prior to testing with a one-way analysis of variance.

	<u>Mean proportion of production</u>		<i>P</i> for difference	Detectable change <sup>b</sup>
	1977-84 broods <sup>a</sup>	1985-89 broods		
Age 2	0.104	0.116	0.787	< 0.055 or > 0.159
Age 3	0.152	0.150	0.811	< 0.087 or > 0.225
Age 4	0.505	0.429	0.286	< 0.409 or > 0.598
Age 5	0.208	0.278	0.340	< 0.120 or > 0.294
Age 5	0.005	0.028	0.004	--

<sup>a</sup> Estimates affected by the El Niño event of 1982-83 were excluded.

<sup>b</sup> From the mean of the 1977-84 brood years.

We found that wild chinook salmon produced after operation of Lost Creek Dam matured at younger ages as compared to counterparts produced before reservoir operation (Table 56). As with spring chinook salmon, age 5 fish were more prevalent among preimpoundment brood years than among postimpoundment brood years. Age 2-4 fish were more prevalent among postimpoundment brood years than among the preimpoundment brood years. These findings suggested that reservoir construction and operation was associated with a change in the maturity rates of wild chinook salmon of Rogue River origin.

We did not compare the proportion of age 6 fish among preimpoundment brood years with pooled postimpoundment brood years. Because age 6 fish were

Table 56. Estimated age composition of wild chinook salmon produced by the 1972-76 brood years as compared to the 1977-89 brood years. Estimates represent projected returns to freshwater without age selective mortality that resulted from fisheries or the El Niño event of 1982-83. Data were arcsin transformed prior to testing with a one-way analysis of variance.

	<u>Mean proportion of production</u>		<i>P</i> for difference
	1972-76 broods	1977-89 broods <sup>a</sup>	
Age 2	0.042	0.109	0.006
Age 3	0.074	0.151	0.031
Age 4	0.365	0.475	0.063
Age 5	0.448	0.234	0.004
Age 6	0.071	0.013	b

<sup>a</sup> Estimates affected by the El Niño event of 1982-83 were excluded.

<sup>b</sup> Tested with a different procedure (see text).

more prevalent among the 1985-89 brood years than among the 1977-84 brood years, we compared both groups to the mean proportion of age 6 fish among brood years produced before operation of Lost Creek Dam. Analysis of variance indicated there was a significant difference ( $P = 0.015$ ) among the groups and a Newman-Keuls multiple range test suggested that the prevalence of age 6 fish differed only between the 1972-76 brood years and the 1977-84 brood years.

We hypothesized that the age composition of all wild chinook salmon was primarily affected by fish size after the first year of life and by ocean physical factors after smolts entered the ocean. Mean scale radius at formation of annulus 1 of wild spring chinook salmon (Appendix Table E-46) was used as an index of fish size after the first year of life. Physical factor data included in the analyses are in Appendix Table E-60. A correlation matrix that outlines the relationships among the indexes of ocean physical factors is in Appendix Table E-59. We did not analyze factors related to the proportion of age 2 fish among completed brood years because the analysis would produce the same results as the analysis of the probability of maturity at age 2 (see Maturity Rates, page 138).

We found that the percentage of age 3 fish produced among the 1972-89 broods was positively related to fish size at annulus 1 and ocean physical parameters in autumn after smolts entered the ocean (Table 57). This finding indicated that the relative abundance of age 3 fish increased when fish were larger at the time of formation of the first annulus. We also found that the percentage of age 5 fish produced among the 1972-89 broods was negatively related to fish size at annulus 1 and ocean physical parameters after smolts entered the ocean (Table 57). This finding indicated that the relative

Table 57. Summary of regression analyses for factors related to the age composition (% of each brood year) of all wild chinook salmon. Percentages were transformed to logits prior to analysis. Data are described in Appendix Tables E-46, E-60, and E-71.

Dependent variable	$r^2$	Independent variable	Regression coefficient	Standard error	$P$
% Age 3	0.71	Radius at annulus 1	$2.902 \times 10^{-2}$	$0.675 \times 10^{-2}$	<0.001
		Autumn upwelling	$-1.127 \times 10^{-2}$	$0.237 \times 10^{-2}$	<0.001
		Autumn temperature	$-6.695 \times 10^{-2}$	$1.785 \times 10^{-2}$	0.002
		Constant	2.439		
% Age 4	0.38	Spring upwelling	$-4.235 \times 10^{-3}$	$1.248 \times 10^{-3}$	0.004
		Constant	0.176		
% Age 5	0.77	Radius at annulus 1	$-2.778 \times 10^{-2}$	$0.807 \times 10^{-2}$	0.005
		Summer upwelling	$3.043 \times 10^{-3}$	$1.002 \times 10^{-3}$	0.010
		Autumn upwelling	$8.397 \times 10^{-3}$	$3.006 \times 10^{-3}$	0.016
		Autumn temperature	$6.840 \times 10^{-1}$	$2.068 \times 10^{-1}$	0.006
		Winter temperature	$-3.177 \times 10^{-1}$	$1.408 \times 10^{-1}$	0.043
		Constant	-3.524		

abundance of age 5 fish decreased when fish were larger at the time of formation of the first annulus. In contrast to age 3 and age 5 fish, the size of fish when annulus one formed was not related to the percentage of age 4 fish within complete broods (Table 57).

**Discussion:** We found that wild fish produced after reservoir operation were younger as compared to counterparts produced in earlier years, and that the age composition of wild fish was related to growth history. As reservoir operation appeared to affect body size at various life history stages (see *Size in the Ocean*, page 134) reservoir operation also probably affected the age composition of wild chinook salmon produced in the upper river.

A change towards a younger age composition among wild fish may be of concern to fishery managers because younger fish contribute at lower rates to the ocean and freshwater fisheries as compared to older fish (see *Ocean Harvest*, page 131 and *Fishery Selectivity*, page 198). In addition, a decreased age among natural spawners may result in reduced stock productivity. These topics are discussed in greater detail in the section on maturity rates.

#### Run Composition

Hatchery fish began to contribute appreciably to the spring chinook salmon run in the Rogue River during the late 1970s (Figure 47). The proportion of hatchery fish among spring chinook salmon increased greatly from the 1970s through the 1990s. Hatchery fish accounted for an average of 7% of the returns in the 1970s, 43% of the returns in the 1980s, and 70% of the returns in 1990-94 (Appendix Table E-2). The proportion of hatchery fish in the run increased because increased numbers of juveniles were produced at Cole M. Rivers Hatchery to compensate for spawning habitat blocked by Lost Creek Dam

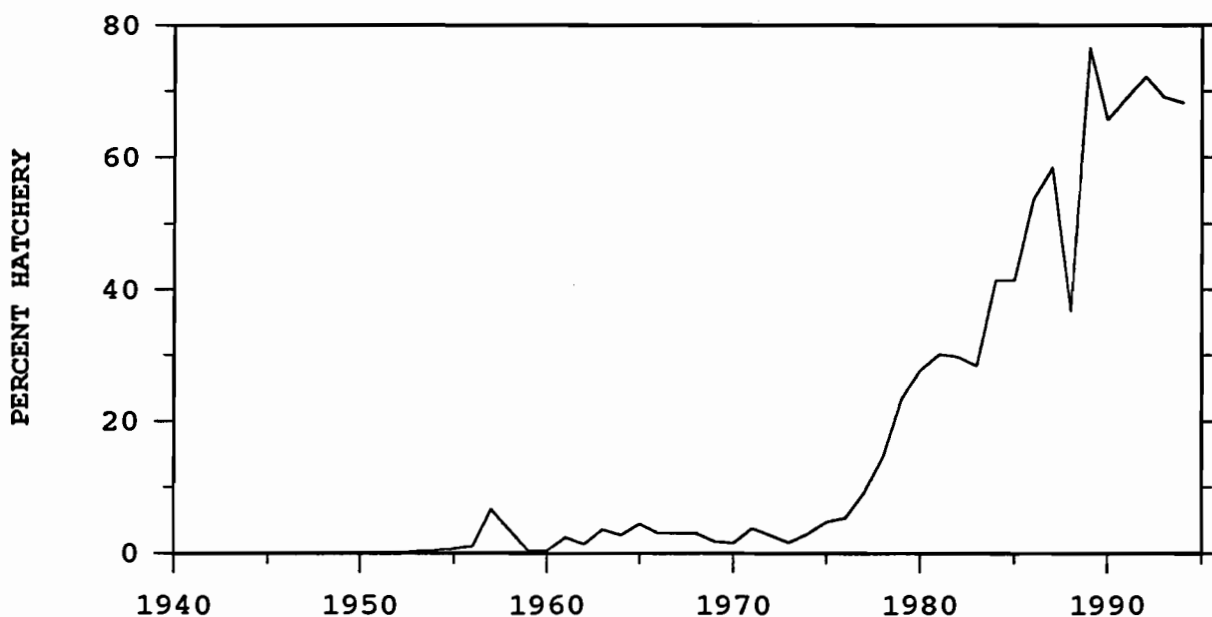

Figure 47. Relative abundance of hatchery fish among spring chinook salmon that passed Gold Ray Dam, 1942-94.

and because the production of wild spring chinook salmon decreased when Lost Creek Dam blocked a portion of the spawning habitat.

The relative abundance of fall chinook salmon among wild chinook salmon increased greatly at Gold Ray Dam during 1975-94 (Figure 48). Percentages of the annual returns that were the fall race averaged 6% in 1942-75, 19% in 1976-90, and 59% in 1991-94. Changes in the race composition of chinook salmon also have been documented in other rivers (Yoshiyama et al. 1998).

We found that the percentage of fall chinook salmon among wild fish increased after the operation of Lost Creek Dam. The median percentage of fall chinook salmon in the returns to Gold Ray Dam was 6% in 1942-80 and was 27% in 1981-94. A Mann-Whitney U-test indicated that the medians differed significantly ( $T = 632$ ,  $P < 0.001$ ). Data included in the analysis were estimated from data in Appendix Table E-2.

We also found that the percentage of fall chinook salmon was greater among broods produced before the operation of Lost Creek Dam as compared to broods produced after reservoir operation. Fall chinook salmon composed accounted for an average of 13.4% of the age 2 fish produced by the 1972-76 brood years and an average of 24.4% of the age 2 fish produced by the 1977-89 brood years. A t-test indicated that the means differed significantly ( $P = 0.021$ ). Data included in the analysis were the estimated numbers of age 2 fish resident in the ocean during spring (Appendix Tables E-28 and E-39).

We hypothesized that the run composition of wild chinook salmon produced in the upper river was primarily affected by (1) the percentage of fall chinook salmon among spawning parents, (2) water temperature during the period eggs and alevins incubated in the gravel, (3) flow during parental spawning, and (4) flow during the period that parental fall chinook salmon were

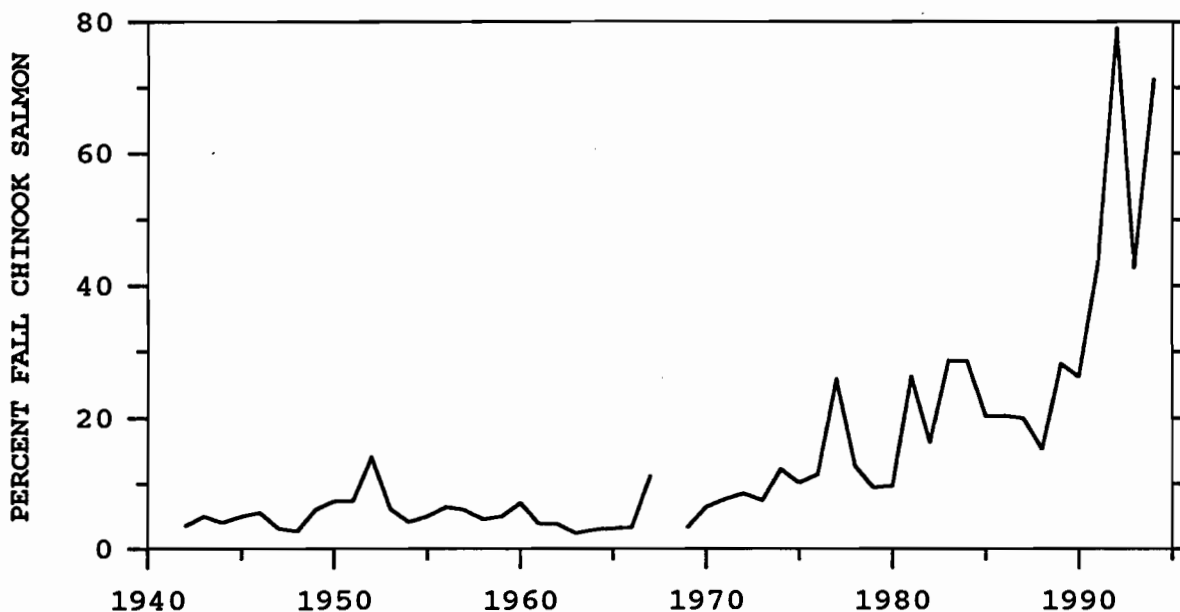

Figure 48. Relative abundance of fall chinook salmon among wild chinook salmon that passed Gold Ray Dam, 1942-94.



susceptible to prespawning mortality. Regression analysis indicated that the percentage of fall chinook salmon among the 1972-89 broods was positively related to the percentage of fall chinook salmon among parental spawners and was negatively related to flow during parental spawning Appendix Table E-72.

However, because the regression analysis accounted for only 31% of the variation in the dependent variable, we concluded that it would be of little value to develop predictions of run composition from under hypothesized values for the independent variables. A correlation matrix that outlines the relationships among all variables examined a regression analysis is in Appendix Table E-73. Data included in the analysis are in Appendix Table E-74.

### Migration Rate

We estimated the migration rates of spring chinook salmon from 460 tags recovered in 1975-78. There were sufficient data to estimate the mean rates of migration rates between the lower river and Gold Ray Dam, between Gold Ray Dam and capture by anglers, and between Gold Ray Dam and Cole M. Rivers Hatchery. Spring chinook salmon migrated at slower rates through the upper river as compared with the area farther downstream (Table 58).

Spring chinook salmon migrated at slower rates between the lower river and Gold Ray Dam in 1977 as compared to 1975-76 (Table 58). Warmer water and disease may have slowed migration rates as fish congregated off the mouths of cooler tributaries (see Prespawning Mortality, page 162). Fish also migrated more at slower rates in the upper river in 1977 as compared to other years (Table 58).

Among fish tagged at Gold Ray Dam, those caught by anglers migrated at faster rates as compared with those that returned to Cole Rivers Hatchery. (Table 58). This difference may indicate that migration rates slow as the fish approach the hatchery or may indicate that fish hold in the river for a protracted period of time prior to entry into the hatchery.

Table 58. Mean migration rates (km per day) of spring chinook salmon in the Rogue River as estimated from the date of tagging and the date of tag recovery, 1975-78.

Year	95% confidence interval		
	Fish tagged in lower river Tags recovered at Gold Ray Dam	Fish tagged at Gold Ray Dam	
		Tags recovered by anglers	Tags recovered at Cole Rivers Hatchery
1975	5.8 ± 0.5	2.1 ± 0.8	1.2 ± 0.1
1976	5.1 ± 0.5	2.3 ± 0.7	1.4 ± 0.4
1977	3.1 ± 1.6	1.5 ± 0.5	1.1 ± 0.4
1978	--	2.6 ± 0.7	1.5 ± 0.2

We caught insufficient numbers of hatchery fish to test for differences in migration rates between wild and hatchery fish. However, there was an indication that early-run fish migrated at slower rates than late-run fish. In 1976, migration rates of fish tagged in the lower river before 22 May averaged 4.4 km/day while fish tagged at later dates averaged 5.3 km/day. The difference in mean migration rates was significant at  $P = 0.073$ . Later migrants may be adapted to move through the Rogue River canyon and through the middle river at a faster rate in order to decrease the chance of being exposed to warm water temperatures during low flow years.

### Migration Timing

Catch estimates from salmon-steelhead cards indicated that most spring chinook salmon enter the Rogue River in April-June (see Timing of Angler Catch, page 187). Spring chinook salmon passed the counting station at Gold Ray Dam from April through the middle of August. Passage of jacks and adults usually peaked in the first half of June although jacks migrate later as compared to adults (Figure 49). Passage estimates used to estimate the migration timing of spring chinook salmon at Gold Ray Dam are in Appendix Tables E-75 and E-76.

Fall chinook salmon passed the counting station at Gold Ray Dam from the middle of August through December. Passage of jacks and adults usually peaked in late August or September (Figure 50). Passage estimates used to estimate the migration timing of fall chinook salmon at Gold Ray Dam are in Appendix Tables E-77 and E-78.

Fall chinook salmon classified as jacks migrated later after reservoir operation. The percentage of jacks that passed the counting station by 15 September averaged 61% in 1942-76 and 44% in 1978-94. A t-test with arcsin transformed data indicated that the means differed significantly ( $P = 0.001$ ). However, we did not detect a similar change in the migration timing of adults. The percentage of adults that passed the counting station by 15 September averaged 52% in 1942-76 and 46% in 1978-93. An t-test with arcsin transformed data indicated that the difference in means was not significant ( $P = 0.109$ ). Data included in the analyses are in Appendix Tables E-77 and E-78.

River physical factors during migration did not appear to be primary determiners of the passage timing of fall chinook salmon at Gold Ray Dam. The percentage of jacks, and the percentage of adults, that passed the counting station by 15 September was not significantly correlated (all  $P > 0.081$ ) to either mean flow or mean maximum water temperature at Raygold during late summer or early autumn.

Among spring chinook salmon, jacks also migrated later after reservoir operation. The percent of jacks that passed the counting station by 30 June averaged 71% in 1942-76 and 59% in 1978-93. A t-test with arcsin transformed data indicated that the difference in means was significant ( $P = 0.013$ ). However, we did not detect a similar change in the migration timing of adults. The percent of adults that passed the counting station by 30 June averaged 84% in 1942-76 and 83% in 1978-93. A t-test with arcsin transformed data indicated that the difference in means was not significant ( $P = 0.588$ ). Data included in the analyses are in Appendix Tables E-75 and E-76.

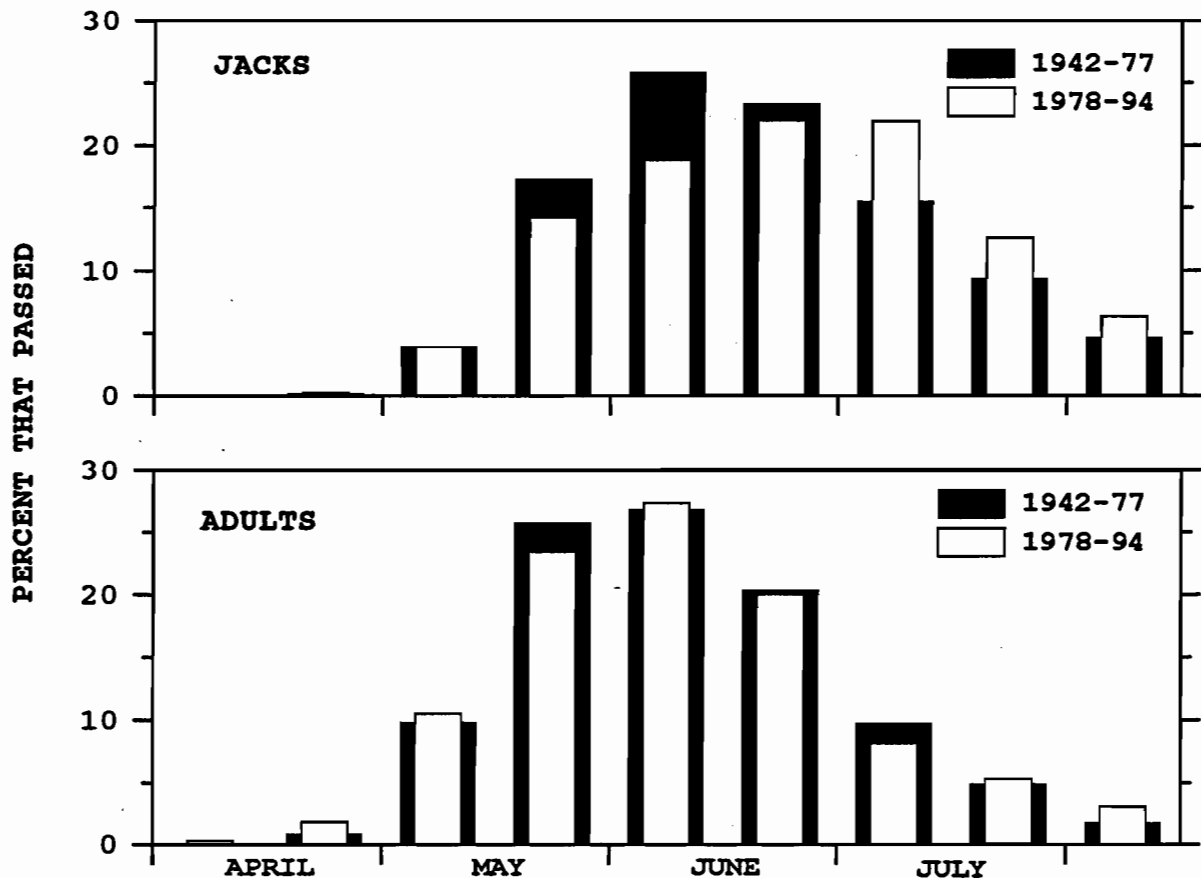

Figure 49. Mean migration timing of spring chinook salmon at Gold Ray Dam, 1942-94. Estimates include wild and hatchery fish.

The migration timing of spring chinook salmon at Gold Ray Dam in 1942-94 was related to river flow during the late spring and early summer. We found that the percentage of jacks that passed the counting station by 31 May was negatively correlated ( $r = -0.35$ ,  $P = 0.009$ ) with mean flow at Raygold in May-June. We also found that the percentage of adults that passed the counting station by 30 June was negatively correlated ( $r = -0.50$ ,  $P = 0.001$ ) with mean flow at Raygold in May-June. These findings indicated that spring chinook salmon tended to pass Gold Ray Dam earlier in years of low flow and later in years of high flow.

Indexes of migration timing at Gold Ray Dam were not significantly correlated with water temperature in late spring and early summer. In addition, indexes of migration timing were not significantly correlated with the percentage of hatchery fish among jacks and adults. Data included in the analyses are in Appendix Table E-79. A correlation matrix that outlines the relationships between variables examined in the analyses is in Appendix Table E-80.

While the migration timing of adult spring chinook salmon at Gold Ray Dam did not change after operation of Lost Creek, there were indications of changes in the migration timing of wild fish. Age 3-5 wild fish produced prior to operation of Lost Creek Dam were trapped at Gold Ray Dam an average

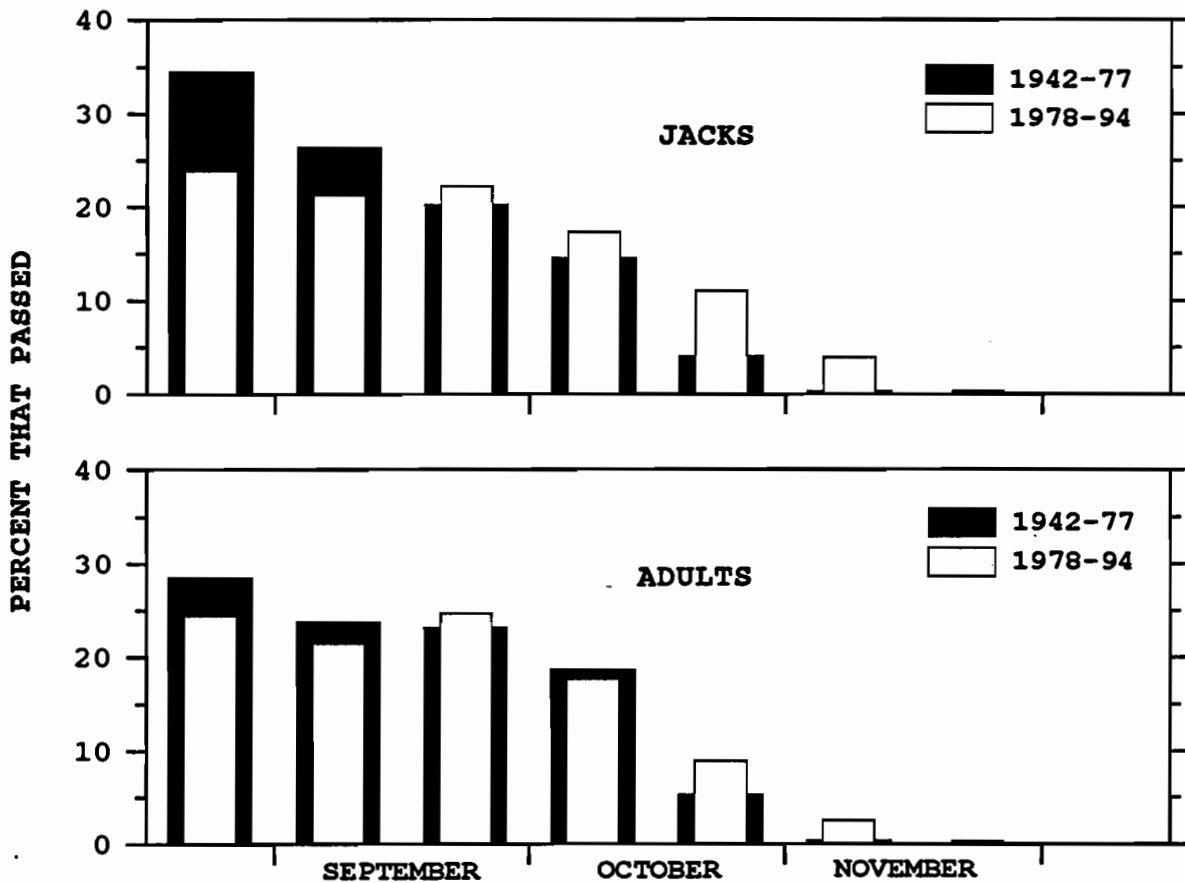

Figure 50. Mean migration timing of fall chinook salmon at Gold Ray Dam, 1942-94. Estimates include wild and hatchery fish.

of 16-18 days later than counterparts produced in later years (Table 59). We chose not to analyze data from age 2 adults because of a small sample size ( $N = 3$ ) for fish produced before operation of Lost Creek Dam. Data included in these analyses are in Appendix Table E-81.

Table 59. Comparisons of the mean date of trapping at Gold Ray Dam for wild age 3-5 spring chinook salmon that were produced before and during operation of Lost Creek Dam. Comparisons were made with t-tests. Data were excluded for years when less than 10 wild fish were trapped or when prespawning mortality exceeded 20%.

Adult age	Origin of brood years		P for difference
	Preimpoundment	Postimpoundment	
3	3 June	19 June	< 0.001
4	28 May	15 June	< 0.001
5	26 May	12 June	< 0.001

Water temperature during the period when eggs and alevins incubated in the gravel appeared to be an important determiner of the migration timing of wild spring chinook salmon. We found that water temperature during the incubation period was positively related to the mean date of trapping at Gold Ray Dam for age 2 ( $P = 0.042$ ), age 3 ( $P = 0.014$ ), age 4 ( $P = 0.001$ ), and age 5 ( $P = 0.042$ ) adults.

In contrast, river flow and water temperature during the migration period were not significantly related to mean dates of trapping for wild age 2-5 adults (Appendix Tables E-82 through E-85). These factors also were not significantly related to the residual variation that resulted from regressions of mean day of trapping on water temperature during the incubation period. Correlation matrixes that outline the relationships between all variables examined in the analyses of the capture time of wild age 2-5 adults are in Appendix Tables E-82 through E-85. Data included in the analyses are in Appendix Table E-86.

We also found that mean dates when age 2-5 hatchery fish were trapped at Gold Ray Dam were not significantly correlated with flow and water temperature when adult fish migrated in late spring and early summer (Appendix Tables E-82 through E-85). These findings also suggested that variations in river physical factors during the period when adult spring chinook migrated were not primary determiners of passage time at Gold Ray Dam.

Older spring chinook salmon passed Gold Ray Dam at earlier dates as compared to younger counterparts. A two-way analysis of variance indicated that mean dates of trapping at Gold Ray Dam differed significantly among age classes of wild adults and that capture dates differed significantly among years (Table 60). A Newman-Keuls multiple range test indicated that mean capture dates differed significantly among each age class of wild adults. Least square means ( $\pm$  standard error) estimated from the two-way analysis of variance were 5 June ( $\pm 0.7$  days) for age 5 fish, 9 June ( $\pm 0.6$  days) for age 4 fish, 15 June ( $\pm 0.4$  days) for age 3 fish, and 30 June ( $\pm 0.8$  days) for age 2 fish. Data included in these estimates are in Appendix Table E-86.

Table 60. Comparison of the mean dates of capture at Gold Ray Dam for wild age 2-5 spring chinook salmon, 1974-94. Data from years when trap catches were less than 10 fish in any age class were excluded from the analysis.

Analysis of variance.					
Source of variation	Sum of squares	df	Mean square	F	P
Age	221,403	3	73,801	256.1	<0.001
Year	409,935	16	25,621	88.9	<0.001
Age x Year	70,936	48	1,478	5.1	<0.001
Residual	2,242,022	4,543	288		

Hatchery fish of older ages also were trapped at Gold Ray Dam earlier than younger counterparts. A two-way analysis of variance indicated that mean dates of trapping at Gold Ray Dam differed significantly among different age classes of hatchery adults and that capture dates differed significantly among years (Table 61). A Newman-Keuls multiple range test indicated that mean capture dates differed significantly among each age class of hatchery fish. Least square means (+ standard error) estimated from the two-way analysis of variance were 31 May (+ 1.1 days) for age 5 fish, 6 June (+ 0.7 days) for age 4 fish, 13 June (+ 0.9 days) for age 3 fish, and 5 July (+ 1.2 days) for age 2 fish. Data included in these estimates are in Appendix Table E-86.

In contrast to wild fish, there were no changes in the time that hatchery fish were trapped at Gold Ray Dam. Mean dates that age 4 hatchery fish were trapped ranged between 1 June and 15 June during 1977-94 (Appendix Table E-81). Conversely, mean dates of trapping for wild fish ranged between 14 May and 2 June in 1974-79 and ranged between 10 June and 24 June in 1980-94 (Appendix Table E-81). This change in migration timing coincided with the first returns of wild fish produced as juveniles after Lost Creek Dam began operation. Comparison of other age classes of wild and hatchery fish showed the same trends as for age 4 fish. Change in the time that wild fish were trapped, in the absence of change in the time that hatchery fish were trapped, also indicates that the migration timing of wild fish is primarily affected by some factor other than river physical factors during the period of adult migration.

Such a shift in migration timing is not without precedence among chinook salmon (Slater 1963; Kwain and Thomas 1984; Quinn and Unwin 1993), and changes in migration timing of sockeye salmon have been related to changes in water temperature and flow during the migration of adult fish (Quinn et al. 1997). In contrast, we found that the change in migration timing of wild spring chinook salmon was more closely associated to changes in water temperature when eggs and alevins incubated in the gravel as compared to changes in water temperature or flow during the period of adult migration.

Table 61. Comparison of the mean dates of capture at Gold Ray Dam for age 2-5 spring chinook salmon of hatchery origin, 1974-94. Data from years when trap catches were less than 10 fish in any age class were excluded from the analysis.

Analysis of variance					
Source of variation	Sum of squares	df	Mean square	F	P
Age	171,359	3	57,120	176.3	<0.001
Year	14,951	10	1,495	4.6	<0.001
Age x Year	32,239	30	1,075	3.3	<0.001
Residual	767,022	2,367	324		

We also found that the migration time of wild spring chinook salmon was positively related to spawning time and that reservoir operation was associated with a decrease in the relative abundance of early spawners as compared to late spawners (see Spawning Time, page 173). The simultaneous change in both life history parameters may reflect a change in the genetic complement of spring chinook salmon in the Rogue River. For example, early-run and late-run chinook salmon in the Kenai River Basin in Alaska compose two discrete populations that can be distinguished by genetic markers (Adams et al. 1994) and differences in genetic composition have been documented for chinook salmon within a single river basin (Beacham et al. 1996).

Fishery managers are concerned about the change in migration timing of wild spring chinook salmon in the Rogue River. The later time of migration likely reduced harvest in the freshwater fisheries because water conditions are more optimal early in the lower river and in the middle river fisheries, and early migrants are susceptible to the upper river fishery longer than late migrants (see Timing of Angler Catch, page 187).

Although we found that operation of Lost Creek Dam affected the migration timing of spring chinook salmon destined to spawn farthest upstream in the Rogue River, we developed no recommendations for an operating strategy directed to migration timing. However, in the next section, we propose recommendations for reservoir management to decrease rates of prespawning mortality among populations that compose the early components of the run. An increase in the relative abundance of adults adapted to return early will give the appearance of an earlier migration time at freshwater entry.

### Prespawning Mortality

We found unspawned carcasses of spring chinook salmon in the Rogue River in all survey areas in each year of surveys. Our findings confirmed previous observations that indicated that in some years, large numbers of spring chinook die in the Rogue River prior to spawning (Rivers 1964). We previously documented that fall chinook salmon in the Rogue River are also susceptible to extensive prespawning mortality (ODFW 1992). Extensive prespawning mortality of Pacific salmon has been observed in other streams and seems to occur primarily when streams are unusually warm during periods of low flow (Murphy 1985; Lindsay et al. 1989; Gilhousen (1990); Fukushima and Smoker (1997).

**Downstream of Gold Ray Dam:** Counts of dead spring chinook salmon in the Rogue River canyon ranged between 1 fish in 1975 and 1,185 fish in 1987 (Appendix Table E-87). Expansions to account for weeks without surveys (see Prespawning Mortality, page 45) suggested that surveyors would have observed between 3 and 2,365 carcasses annually in 1975-94 (Appendix Table E-88).

We estimated that the number of spring chinook salmon that died downstream of Gold Ray Dam ranged between 43 fish in 1975 and 31,579 fish in 1987, and that mortality rates annually ranged between 0.2% and 70.2% (Table 62). We did not attempt to estimate separate rates of prespawning mortality for wild and hatchery fish, or fish of different ages because few unspawned carcasses of spring chinook salmon were examined or measured during surveys in the Rogue River canyon.

Table 62. Estimated number of spring chinook salmon that died in the Rogue River downstream of Gold Ray Dam, 1975-81, 1987, 1992, and 1994. Estimates were derived from data in Appendix Table E-88 and regressions in Table 12.

Year	Number that died	Mortality rate (%)	Year	Number that died	Mortality rate (%)
1975	43	0.2	1980	226	0.6
1976	156	0.7	1981	1,071	5.8
1977	8,539	34.2	1987	31,579	27.9
1978	790	1.6	1992	13,684	70.2
1979	1,889	4.7	1994	20,134	58.8

We used regressions developed for fall chinook salmon in the Rogue River (ODFW 1992) to estimate the number of spring chinook salmon that died downstream of Gold Ray Dam. This estimation procedure assumed that the distribution of prespawning mortality in the Rogue River did not differ between spring chinook salmon and fall chinook salmon. This assumption is likely erroneous because we observed unspawned carcasses of spring chinook salmon, but few unspawned carcasses of fall chinook salmon, in the middle river.

However, in the lower river we rarely observed unspawned carcasses of spring chinook salmon, but commonly found unspawned carcasses of fall chinook salmon. Uncertainty associated with the assumption of similar distributions of prespawning mortality lead us to compare mortality estimates developed from carcass counts with mortality estimates developed from comparisons of returns of spring chinook salmon to Gold Ray Dam with returns of chinook salmon in other areas of the region.

We found that the returns of wild spring chinook salmon to Gold Ray Dam were significantly related to estimates of naturally spawned fall chinook salmon in the Rogue River Basin and in the Klamath River Basin for age 2, age 3, and age 4 cohorts (Table 63). Returns of wild age 5 spring chinook salmon were also significantly related to the abundance of cohorts that spawned as fall chinook salmon in the Rogue River Basin, but were not significantly related to the abundance of cohorts that spawned in the Klamath River Basin.

We used the regressions in Table 63 to estimate the number of wild spring chinook salmon that would have returned to Gold Ray Dam in 1987, 1992, and 1994 as if there had been no prespawning mortality (Appendix Table E-89). Rates of prespawning mortality were estimated by dividing the actual returns to Gold Ray Dam by the returns predicted by regressions specific to each age of wild spring chinook salmon (Table 63).

Rates of prespawning mortality as estimated from returns of fall chinook salmon in the Rogue River and Klamath River basins varied widely for some age classes in some years. Estimates were especially disparate for age 2 and age 4 fish in 1987 (Table 64). However, the averages of both estimates were very similar to mortality estimates developed from carcass counts, particularly for age 4 fish (Table 64). Because age 4 fish tend to dominate the returns of



Table 63. Regressions of the numbers of age 2-5 wild spring chinook salmon that passed Gold Ray Dam on abundance indexes of cohorts among wild fall chinook salmon that spawned naturally in the Rogue River and Klamath River basins. Data from the 1987, 1992, and 1994 return years are not included in the analyses.

Fall chinook salmon	Years	<i>N</i>	$r^2$	<i>P</i>	slope	$s_b^2$
AGE 2						
Rogue River	1978-93	14	0.72	<0.001	3.026	0.280
Klamath River	1981-93	11	0.86	<0.001	0.198	0.001
AGE 3						
Rogue River	1978-93	14	0.82	<0.001	1.465	0.037
Klamath River	1982-93	10	0.81	<0.001	0.223	0.001
AGE 4						
Rogue River	1978-93	14	0.78	<0.001	2.317	0.117
Klamath River	1983-93	9	0.44	0.038	0.284	0.013
AGE 5						
Rogue River	1984-93	8	0.77	0.002	2.725	0.321
Klamath River	1984-93	8	0.35	0.094	1.375	0.503

wild spring chinook salmon in the Rogue River, and larger fish are most easily seen during carcass surveys, we concluded that use of carcass counts in the Rogue River canyon to estimate the number of spring chinook salmon that died downstream of Gold Ray Dam were of sufficient reliability to warrant further analysis.

We hypothesized that water temperature, flow, and fish abundance were primary determiners of the mortality rate of adult spring chinook salmon in the lower river. We found that the rate of prespawning mortality among spring chinook salmon in the area downstream of Gold Ray Dam in 1975-94 was positively related with average water temperature in the Rogue River canyon during late spring and early summer (Figure 51). Mortality rate increased as water temperature increased. Regression analysis (Appendix Table E-90) predicted mortality rates of 1% at 17°C, 5% at 18°C, 18% at 19°C, and 48% at 19°C.

The abundance of spring chinook salmon was not significantly related to the residual variation resulting from the first step of the regression, suggesting that fish abundance was a less important determinant of mortality rates as compared with water temperature. We did not test for the additional influence of flow because water temperature and flow were highly correlated ( $P = 0.007$ ) and because flow affects water temperature at this time of the year in the Rogue River canyon (USACE 1991). Data included in the analysis

Table 64. Rates of prespawning mortality among age 2-5 wild spring chinook salmon that died downstream of Gold Ray Dam in 1987, 1992, and 1994 estimated from carcass counts in the Rogue River canyon in comparison to mortality rates estimated from abundance indexes of fall chinook salmon that spawned naturally in the Rogue River and Klamath River basins.

Year	Mortality rate (%)			
	Estimates from fall chinook salmon			Estimates from carcass counts
	Rogue River	Klamath River	Mean	
AGE 2				
1987	56.7	1.3	29.0	27.9
1992	87.2	90.2	88.7	70.2
1994	98.2	98.0	98.1	58.8
AGE 3				
1987	20.1	32.7	26.4	27.9
1992	69.4	85.9	77.6	70.2
1994	70.9	94.4	82.6	58.8
AGE 4				
1987	59.0	0.0	29.5	27.9
1992	75.6	72.8	74.2	70.2
1994	84.7	29.2	57.0	58.8
AGE 5				
1987	0.0	--	--	27.9
1992	75.5	--	--	70.2
1994	18.6	--	--	58.8

are in Appendix Table E-91 and a correlation matrix that outlines the relationships between all variables examined in the analysis is in Appendix Table E-92.

**Upstream of Gold Ray Dam:** Recoveries of dead spring chinook salmon before the start of spawning ranged between 72 fish in 1980 and 705 fish in 1977. Surveys were conducted only in 1977-81 and in 1988-90. Numbers of unspawned spring chinook salmon found during surveys conducted in June-August are in Appendix Tables E-93 and E-94. We estimated the total number of wild and hatchery spring chinook salmon that died prior to spawning with four estimation procedures. First, we expanded the number of carcasses recovered to adjust for weeks, and areas, that were not sampled (Appendix Table E-95). Second, we estimated the proportion of fish that were recovered by surveyors as either spawned or unspawned carcasses (Appendix Table E-96). Finally, we used estimates of recovery rates to estimate the number of fish that died prior to spawning (Appendix Table E-97).

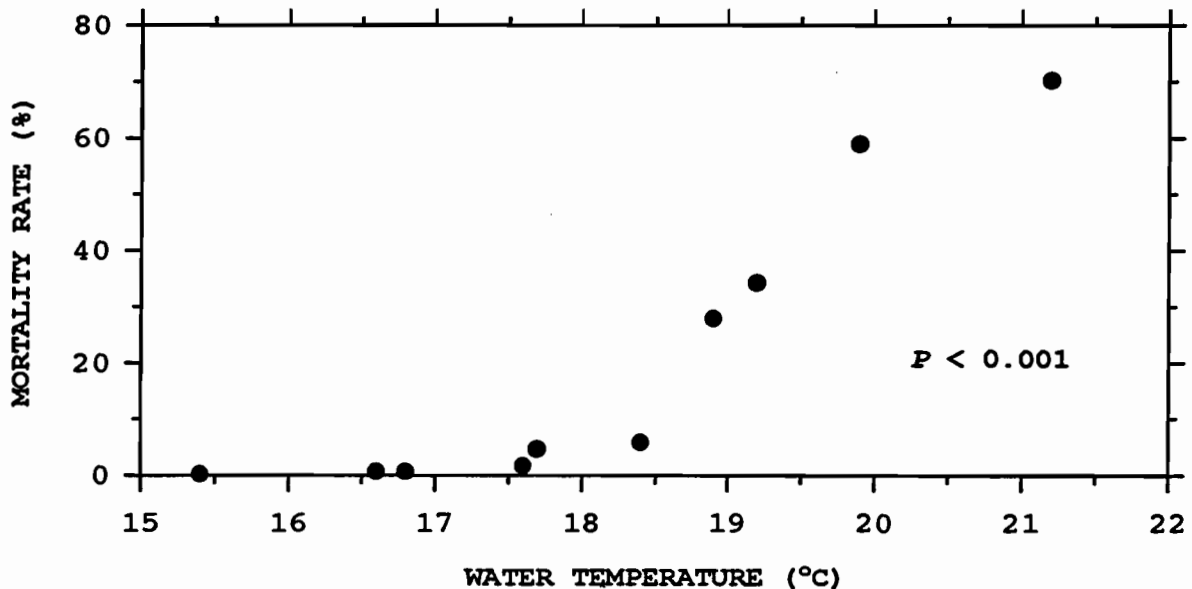

Figure 51. Relationship between the estimated rate of prespawning mortality for spring chinook salmon downstream of Gold Ray Dam and mean maximum water temperature at Mariel in May-June. Estimates include wild and hatchery fish. The  $P$  value was estimated after mortality rates were transformed to logits.

We estimated that annual rates of prespawning mortality among spring chinook salmon  $> 60$  cm in the upper river ranged between 1% and 22% for wild fish and ranged between 3% and 63% for hatchery fish (Appendix Table E-97). Hatchery fish died at greater rates than wild fish in 1977, 1978, 1981, and 1990 for some unknown reason(s).

The rate of prespawning mortality among wild fish in the upper river was positively related with water temperature in the late spring and early summer (Figure 52). Mortality rate increased as water temperature increased. Regression analysis (Appendix Table E-98) predicted mortality rates of 4% at  $17^{\circ}\text{C}$ , 9% at  $18^{\circ}\text{C}$ , 21% at  $19^{\circ}\text{C}$ , and 42% at  $20^{\circ}\text{C}$ . Data included in the analysis are in Appendix Table E-100. A correlation matrix that outlines the relationships between variables examined in the analysis is in Appendix Table E-101.

The rate of prespawning mortality among hatchery fish in the upper river was also positively related with water temperature in the late spring and early summer (Figure 53). As with wild fish, mortality rate increased as water temperature increased. Regression analysis (Appendix Table E-99) predicted mortality rates of 8% at  $17^{\circ}\text{C}$ , 26% at  $18^{\circ}\text{C}$ , 59% at  $19^{\circ}\text{C}$ , and 85% at  $20^{\circ}\text{C}$ . Data included in the analysis are in Appendix Table E-100. A correlation matrix that outlines the relationships between variables examined in the analysis is in Appendix Table E-101.

We did not evaluate any relationship between mortality rate and flow because water temperature and flow were correlated ( $r = -0.84$ ,  $P = 0.009$ ) and because flow affects water temperature at this time of the year in the upper river (USACE 1991). We used the relationships between water temperature and mortality rate to estimate the number of wild and hatchery fish that died prior to spawning in 1974-76 and in 1982-94 (Appendix Table E-102).

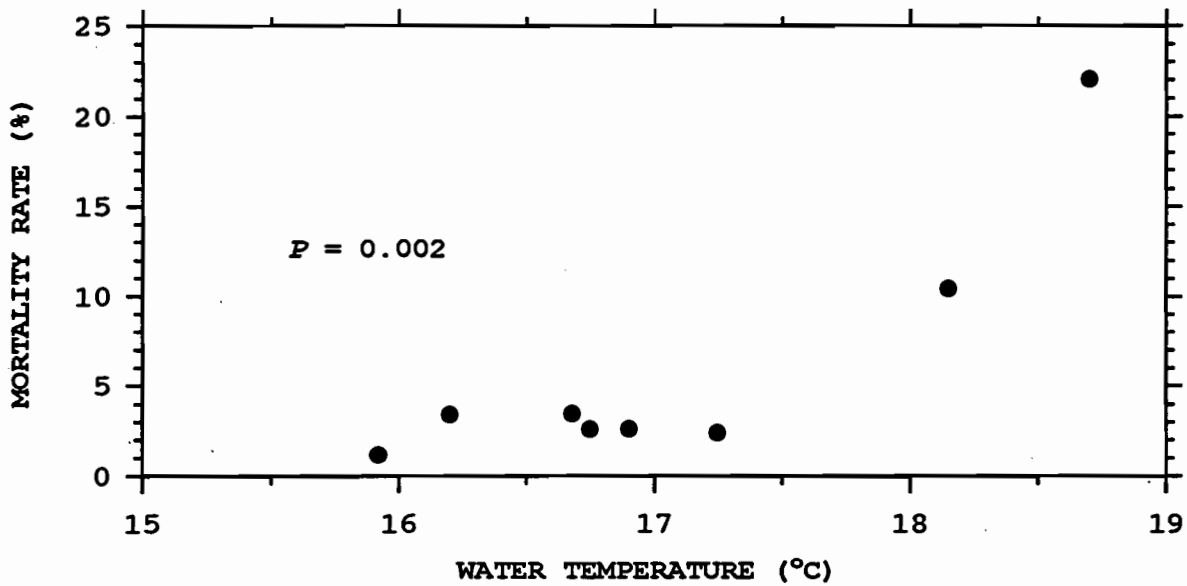

Figure 52. Relationship between the estimated rate of prespawning mortality for wild spring chinook salmon upstream of Gold Ray Dam and mean maximum water temperature at Dodge Bridge in June-July. The  $P$  value was estimated after mortality rates were transformed to logits.

Discussion: We believe that disease was probably the factor responsible for the extensive prespawning mortality among spring chinook salmon in years when water temperatures were significantly exceeded average in late spring and early summer. No acutely toxic levels of chemicals or heavy metals were found in water samples or in tissue samples taken from adult chinook salmon (Cramer and McPherson 1983). Several disease organisms were isolated from dead and

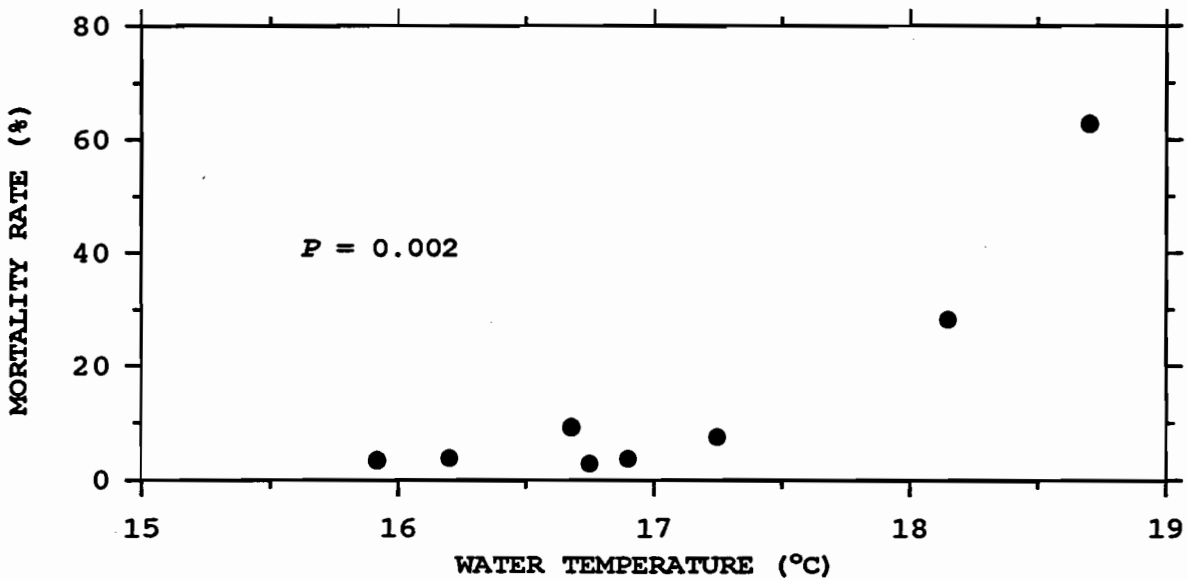

Figure 53. Relationship between the estimated rate of prespawning mortality for spring chinook salmon of hatchery origin upstream of Gold Ray Dam and mean maximum water temperature at Dodge Bridge in June-July. The  $P$  value was estimated after mortality rates were transformed to logits.

dying fish, but cause of death could not be attributed to any one organism (Amandi et al. 1982).

*Flexibacter columnaris*, a bacterial pathogen, was the disease organism most often isolated from dead and dying fall chinook salmon sampled in the Rogue River (Amandi et al. 1982). Virulence of this bacterium varies among strains and epizootics may occur intermittently in salmonid populations (Becker and Fujihara 1978). Mortality rates of juvenile chinook salmon infected with *Flexibacter columnaris* increase as water temperature increases between 12°C and 21°C (Holt et al. 1975; Becker and Fujihara 1978). Spring chinook salmon in the Rogue River are annually exposed to water temperatures close to the upper end of this range.

*Flexibacter columnaris* was detected in resident fish in Lost Creek Lake and in juvenile chinook salmon held in the reservoir, but was not detected in reservoir water or reservoir outflow (Amandi et al. 1982). Greatest concentrations of the pathogen were detected in the outflow from Cole M. Rivers Hatchery. Spring chinook salmon in the hatchery also were found to be infected with the disease. We do not know whether adult salmon carried the disease into the hatchery or contracted the disease after entry. *Flexibacter columnaris* was also found in several species of fish sampled throughout the Rogue River Basin, including the Applegate River (Amandi et al. 1982).

We were unable to determine whether the presence of fish in the reservoir or at mitigation hatchery affected rates of prespawning mortality for fall chinook salmon in the Rogue River. In most cases, fish mortality associated with operation of reservoirs occurs in close proximity to the dams (Grizzle 1981). We commonly found dead spring chinook salmon more than 200 km downstream of Lost Creek Dam. However, *Flexibacter columnaris* can survive for at least five days in flowing water (Amandi et al. 1982). Also, fish throughout the river can become infected and release more pathogens that spread farther downstream.

Regardless of the factor(s) responsible for prespawning mortality, our findings indicate outflows from Lost Creek Dam can be managed to minimize mortality of spring chinook salmon in the Rogue River. During most years, the reservoir can be managed to that average water temperature in the Rogue River canyon does not exceed 18.0°C during May through June. To meet this target for water temperature, outflow from Lost Creek Dam should be managed to maintain a minimum flow of 4,000 cfs at Agness. No reports of prespawning mortality were received by ODFW staff when this minimum flow was attained at Agness in May-June of 1995-97.

River flow must be augmented to decrease water temperature in the Rogue River canyon because effects of outflow temperature diminish rapidly with distance downstream (USACE 1991). Improvements in water quality will decrease stress on migrating spring chinook salmon and thus should reduce potential mortality from other infectious diseases (Wedemeyer 1970; Snieszko 1974).

The recommended minimum flow at Agness in May-June should be considered provisional. Additional simulations of water temperature in the river and in the reservoir, under varied yields of water from the Rogue River, would provide better estimates of how much flow is needed to attain the 18°C objective of water temperature at Agness in late spring and early summer. In

years of extremely low water yields, as in 1992 and 1994, reservoir storage will be insufficient to maintain a minimum flow of 4,000 cfs at Agness through the end of June. In those types of years, it may be valuable to scale daily reservoir releases in May-June to 3-5 day forecasts of air temperatures by the National Weather Service. During periods of expected cool weather, less water would need to be released from the reservoir while releases could be increased during periods of expected hot weather.

### Spawning Distribution

We recovered tags from 64 spawned carcasses of chinook salmon that were tagged in the lower river during April-June in 1974-77. All tags except three were recovered upstream of Gold Ray Dam. In addition, 63 chinook salmon tagged in the lower river in April-June of 1974-76 entered Cole M. Rivers Hatchery. Based on the distribution of these tag recoveries, we concluded that almost all spring chinook salmon spawned upstream of Gold Ray Dam.

We also recovered tags from 561 spawned carcasses of chinook salmon tagged at Gold Ray Dam in 1974-78 and in 1986-87. Annual recoveries of tags ranged from a low of 11 in 1977 to a high of 171 in 1987. We recovered 260 tags from spring chinook salmon that originated from broods produced before the operation of Lost Creek Dam. We also recovered 213 tags from spring chinook salmon produced in postimpoundment years. However, we recovered only 19 tags from fall chinook salmon produced in preimpoundment years and recovered 69 tags from counterparts produced in postimpoundment years. Summaries of these tag recoveries are in Appendix Tables E-103 and E-104.

The spawning distribution of fall chinook salmon overlapped the spawning distribution of spring chinook salmon. Tag recoveries indicated that the overlap was greatest in the area downstream of Lewis Creek (RK 241). Few fall chinook salmon spawned in areas farther upstream (Figure 54). However, the overlap in spawning distribution between the spring and fall races increased when adults that originated from postimpoundment broods returned to spawn.

Tag recoveries from spring chinook salmon indicated that postimpoundment broods spawned farther downstream than preimpoundment broods. In 1974-78, we recovered 48% of the tags in the area closest to Lost Creek Dam (RK 241-252). In 1986-87, only 31% of the tag recoveries came from this area. The change in the distribution of tag recoveries was significant (Chi-square = 14.92,  $P < 0.001$ ). However, there was no significant change in the percentage of tagged spring chinook salmon recovered in Big Butte Creek (Chi-square = 0.96,  $P = 0.328$ ).

We also did not detect any change in the spawning distribution of fall chinook salmon. Adults of preimpoundment origin and postimpoundment origin spawned in the mainstem primarily between RK 205 and RK 216 (Figure 54). In this area, we found 68% of the tags recovered in 1974-78 and 55% of the tags recovered in 1986-87. The change in distribution of tag recoveries was not significant ( $P = 0.576$ ). Small sample sizes (19 in 1974-78 and 69 in 1986-87) decreased the sensitivity of this analysis.

We found that the location of spawning was related to the date that fish passed Gold Ray Dam. Early migrants tended to spawn farther upstream than

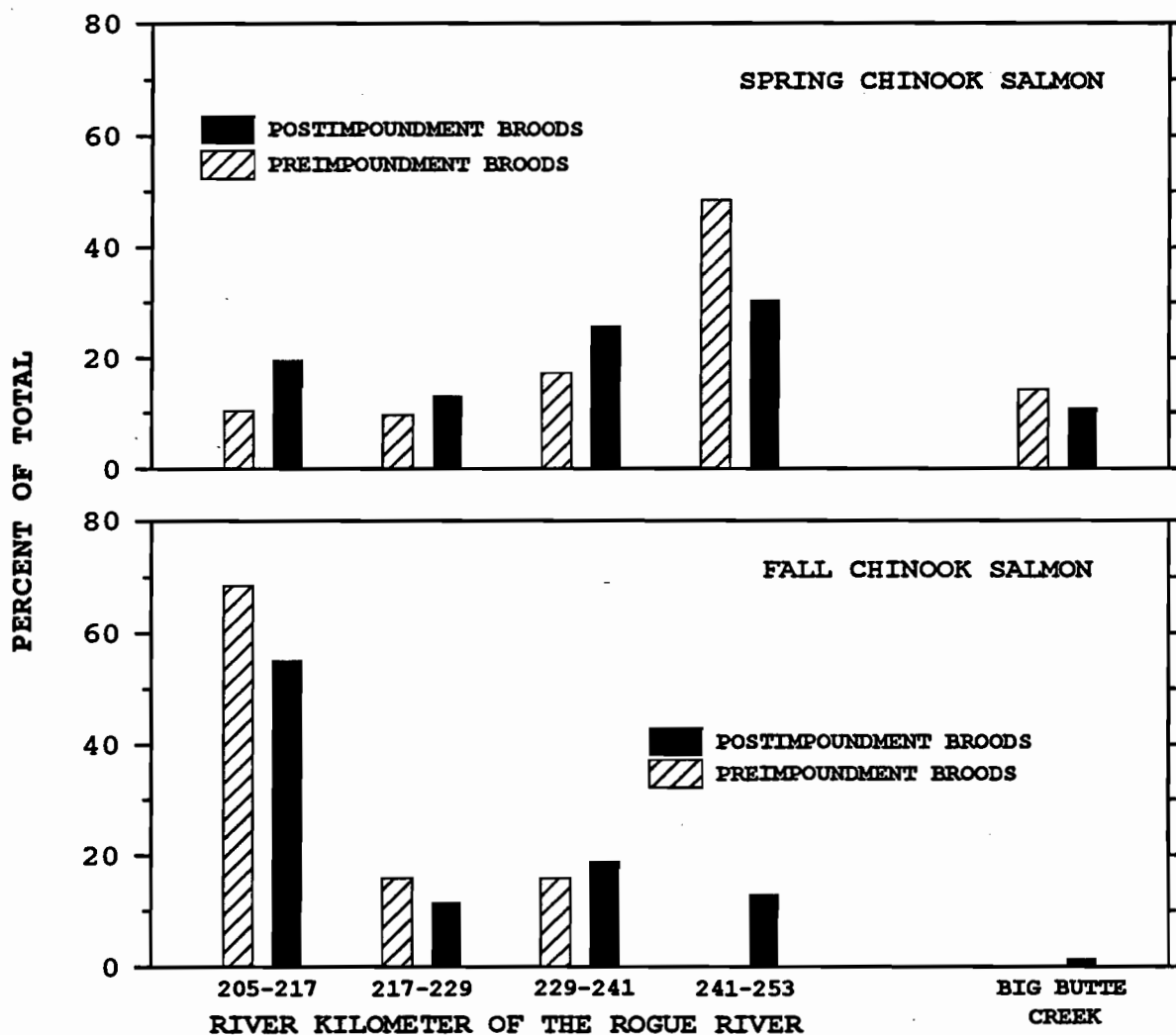

Figure 54. Distribution of tags recovered from spawned carcasses of chinook salmon produced before and after reservoir operation. Data were grouped so that areas were of similar distance.

late migrants. The negative relationship between the two variables was significant for each year except in 1974 (Table 65). During 1974, we were unable to recover any tags from late migrants that passed Gold Ray Dam. Correlation coefficients ranged between -0.47 and -0.53 for those years when we recovered at least 10 tags from fall chinook salmon.

Regressions of spawning location on migration timing did not differ significantly ( $P = 0.221$  for slopes;  $P = 0.164$  for elevations) among brood years produced before the operation of Lost Creek Dam. Also, regressions of spawning location on migration timing did not differ significantly ( $P = 0.899$  for slopes;  $P = 0.590$  for elevations) among postimpoundment broods. Consequently, we used pooled data from 1974-78 to represent preimpoundment broods and used pooled data from 1986-87 to represent postimpoundment broods.

We found that the relationship between spawning location and migration time did not change after the operation of Lost Creek Dam. Elevations and

Table 65. Regressions of river kilometer of tag recovery (Y) on calendar day of tagging (X) for chinook salmon tagged at Gold Ray Dam and recovered as spawned carcasses. Day-of-year calendar is in APPENDIX A.

Year	Regression	SE of slope	N	r	P
1974	Y = 246.2 - 0.055X	0.159	50	-0.05	0.729
1975	Y = 303.4 - 0.394X	0.111	27	-0.58	0.002
1976	Y = 294.7 - 0.342X	0.059	45	-0.66	<0.001
1977	Y = 292.7 - 0.270X	0.060	9	-0.86	0.003
1978	Y = 279.2 - 0.235X	0.036	110	-0.53	<0.001
1986	Y = 266.9 - 0.180X	0.030	98	-0.53	<0.001
1987	Y = 264.9 - 0.175X	0.026	160	-0.47	<0.001

slopes of pooled regressions did not differ significantly between preimpoundment and postimpoundment broods (Table 66). We also examined the mean kilometer of spawning of fish tagged in May and found no significant difference ( $P = 0.727$ ) between preimpoundment and postimpoundment broods. Because there was no change in the spawning location of early migrating adults, we concluded that a decrease in relative abundance of early migrating adults was responsible for the downstream shift in spawning distribution among all spring chinook salmon.

Analysis of the spawning distribution of wild female chinook salmon also suggested that the spawning distribution of spring chinook salmon shifted downstream after the juveniles produced after the operation of Lost Creek Dam returned to spawn. Among wild females that originated from preimpoundment broods, an average of 73% spawned upstream of Shady Cove. Among counterparts that originated from postimpoundment broods, an average of 60% spawned upstream of Shady Cove. The difference in means of arcsin transformed data was significant ( $P = 0.004$ ) and agreed with results of analysis of tagged fish. Data included in the analysis are in Appendix Tables E-105 and E-106.

Results from correlation analyses of factors related to the spawning distribution of wild female chinook salmon were inconclusive. Annual

Table 66. Regressions of river kilometer of carcass recovery (Y) on calendar day of passage at Gold Ray Dam (X) for chinook salmon, preimpoundment broods (1974-78 returns) compared with postimpoundment broods (1986-87 returns). Day-of-year calendar is in APPENDIX A.

Years	N	Regression	SE of slope	r	P for difference	
					Elevations	Slopes
1974-78	241	Y = 278.1 - 0.236X	0.026	-0.53	0.250	0.067
1986-87	258	Y = 265.4 - 0.175X	0.020	-0.49		



estimates of the percentage of females that spawned upstream of Shady Cove was significantly correlated with flow during the spawning period. Upstream shifts in spawning distribution of chinook salmon have been related to increased flow during, or just before, spawning (Fustish et al. 1988; Bradford 1994).

However, many of the variables examined in the analysis were significantly correlated (Appendix Table E-107). In addition, broods produced before reservoir operation composed most of the data in the analysis because we did not estimate spawning distribution in 1982-85 or in 1988-94. Inclusion of more broods produced after reservoir operation may have resulted in different findings. Data included in the analyses are in Appendix Table E-108.

Spawning distribution of chinook salmon also appeared related to spawning time. Among tagged fish, spawning location correlated significantly with spawning time in three of the seven years that we sampled (Table 67). In contrast, spawning location correlated significantly with migration timing in six of seven years (Table 65). Comparisons of correlation coefficients indicated that spawning distribution was more highly related to migration time than spawning time for tagged fish recovered from preimpoundment broods ( $Z = 3.05$ ) and postimpoundment broods ( $Z = 4.46$ ).

We believe that decreased survival of the progeny of spring chinook salmon that migrated early probably resulted in a downstream shift in spawning distribution among cohorts that survived to spawn. This conclusion was based on the finding that early migrants spawned farther upstream than late migrants. The decrease in the relative abundance of early migrants resulted in an increase in the relative abundance of late migrants that spawned in areas farther downstream.

In contrast to wild fish, few spring chinook salmon of hatchery origin spawned downstream of Shady Cove. Most hatchery fish spawned in areas proximal to Cole M. Rivers Hatchery (Cramer et al. 1985). Cramer et al. (1985) estimated that about 5% of the hatchery fish spawned naturally. This estimate appears commensurate with estimates produced from other studies where juvenile chinook salmon were released directly from a hatchery at which returning adults were unable to pass upstream of the hatchery location (Lister et al. 1981; Quinn and Fresh 1984).

Table 67. Correlations of river kilometer of tag recovery and calendar day of tag recovery for chinook salmon tagged at Gold Ray Dam and recovered as spawned carcasses.

Year	N	r	P	Year	N	r	P
1974	50	0.05	0.710	1978	110	-0.24	0.011
1975	27	-0.25	0.209	1986	98	-0.16	0.100
1976	45	-0.66	<0.001	1987	160	-0.14	0.077
1977	9	-0.93	<0.001				

## Spawning Time

We estimated the spawning time of wild chinook salmon from the recovery time of spawned carcasses. We were able to segregate spring chinook salmon from fall chinook salmon for fish that were tagged at Gold Ray Dam in 1974-78 and in 1986-87. Tag recoveries also indicated that few fall chinook salmon spawned upstream of Lewis Creek (RK 241). Consequently, we assumed that carcasses recovered in the RK 235-245 and RK 245-252 survey areas were spring chinook salmon. Otherwise, we were unable to conclusively differentiate the different races of fish. We report recovery times of unmarked carcasses only for females (Appendix Tables E-109 through E-115). Spawner lengths, coupled with the results of scale analyses, indicated that males matured at ages 2-5 while most females matured at age 4.

Analysis of tag recoveries indicated that the spawning time of fall chinook salmon overlapped the spawning time of spring chinook salmon for postimpoundment broods that spawned in the area between Trail Creek and the pool upstream of Gold Ray Dam. In this area, both races of chinook salmon spawned primarily between late September and the end of October (Figure 55), and peaked in the second week of October. We did not estimate the spawning time of fall chinook salmon in the area farther upstream because we recovered few carcasses of fall chinook salmon in the area upstream of Trail Creek. Also, we did not estimate the spawning time of fall chinook salmon that originated from preimpoundment broods because few fall chinook salmon spawned upstream of Gold Ray Dam.

Tag recoveries indicated that fall chinook salmon spawned an average of 5 days later than spring chinook salmon. Assuming that female spring chinook salmon spent 14 days at the site of their redd and prevented other females from spawning at that site (Neilson and Banford 1983), we concluded that few redds of spring chinook salmon were disturbed by fall chinook salmon.

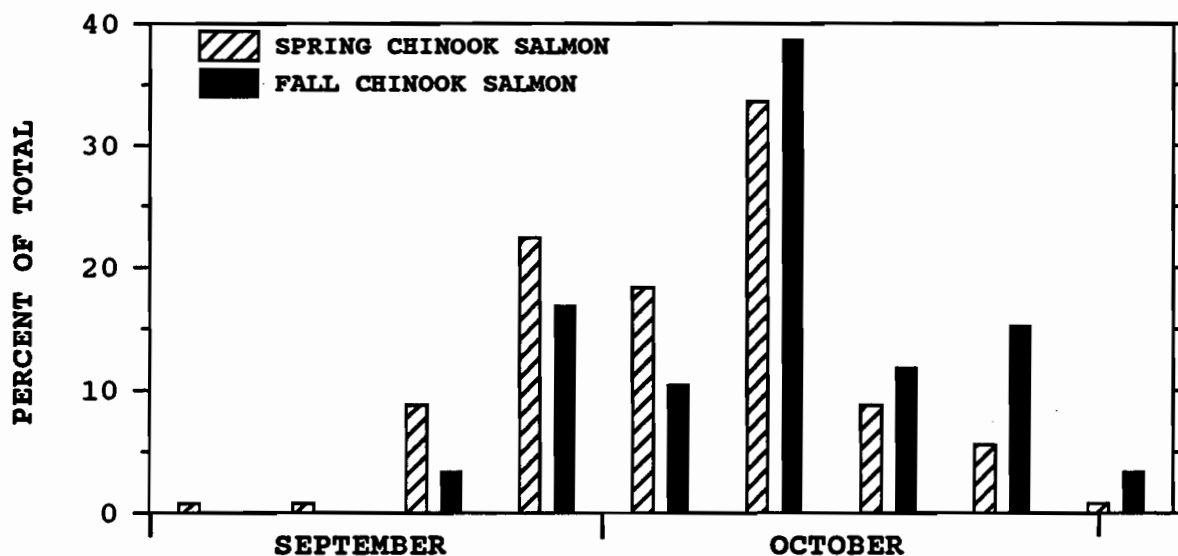

Figure 55. Estimated spawning time of chinook salmon produced after reservoir operation. Data are from tagged carcasses recovered downstream of Trail Creek, 1986-87.

Combined tag recoveries from all areas indicated that among spring chinook salmon, adults that originated from postimpoundment broods spawned later than adults that originated from preimpoundment broods (Figure 56). Among preimpoundment broods, spawning peaked during late September. Spawning by postimpoundment broods peaked 2 weeks later. From tag recoveries, we estimated that 70% of the preimpoundment broods spawned during September, as compared with only 38% of the postimpoundment broods.

Recoveries of unmarked carcasses also indicated that chinook salmon that originated from postimpoundment broods spawned later than preimpoundment broods. In the survey area closest to Lost Creek Dam (RK 245-252), spawning by preimpoundment broods peaked during the middle or later portion of September, while spawning by postimpoundment broods peaked during early October (Figure 57). Time of spawning in the RK 235-245 area also peaked later for broods produced after the operation of Lost Creek Dam (Figure 57). Because tag recoveries indicated that few fall chinook salmon spawned in these areas, later spawning by spring chinook salmon was probably responsible for the change in spawning time.

Among spring chinook salmon that spawned in Big Butte Creek, broods produced after the operation of Lost Creek Dam also spawned later as compared to preimpoundment broods (Figure 57). We estimated that an average of 52% of the postimpoundment broods spawned during September, compared with an average of 34% of the preimpoundment broods.

Annual estimates of the mean date of spawning in Big Butte Creek and in the upper portion of the Rogue River between late September and the middle of October for female chinook salmon. Females that spawned farther upstream tended to spawn later than counterparts that spawned farther downstream (Appendix Table E-116). We estimated the mean dates of spawning from data in Appendix Tables E-109 through E-115.

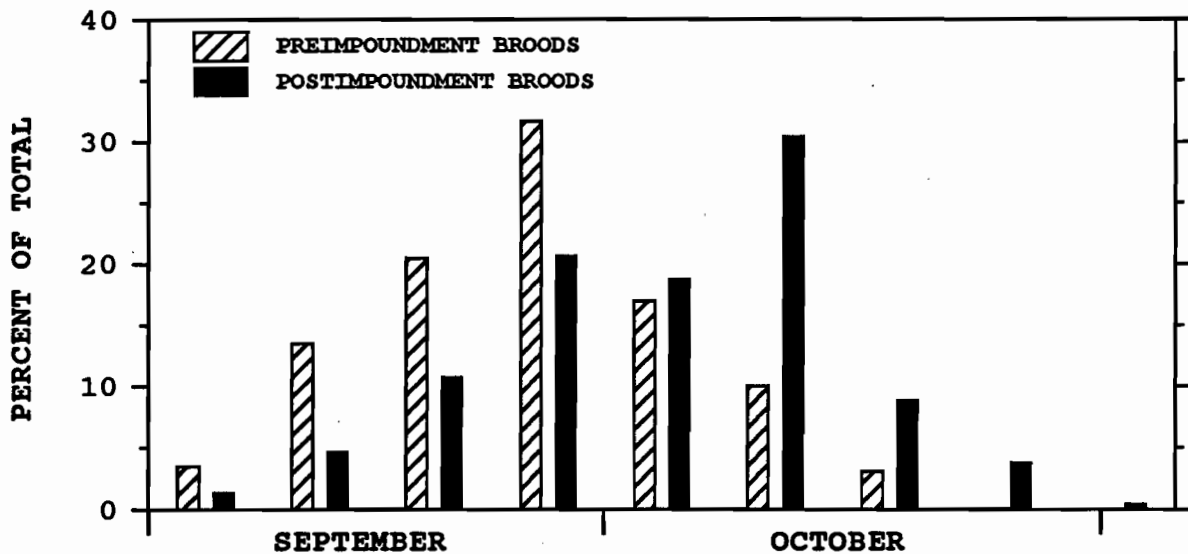

Figure 56. Estimated spawning time of spring chinook salmon produced before and during reservoir operation. Data are from tagged carcasses recovered in 1974-78 and in 1986-87.

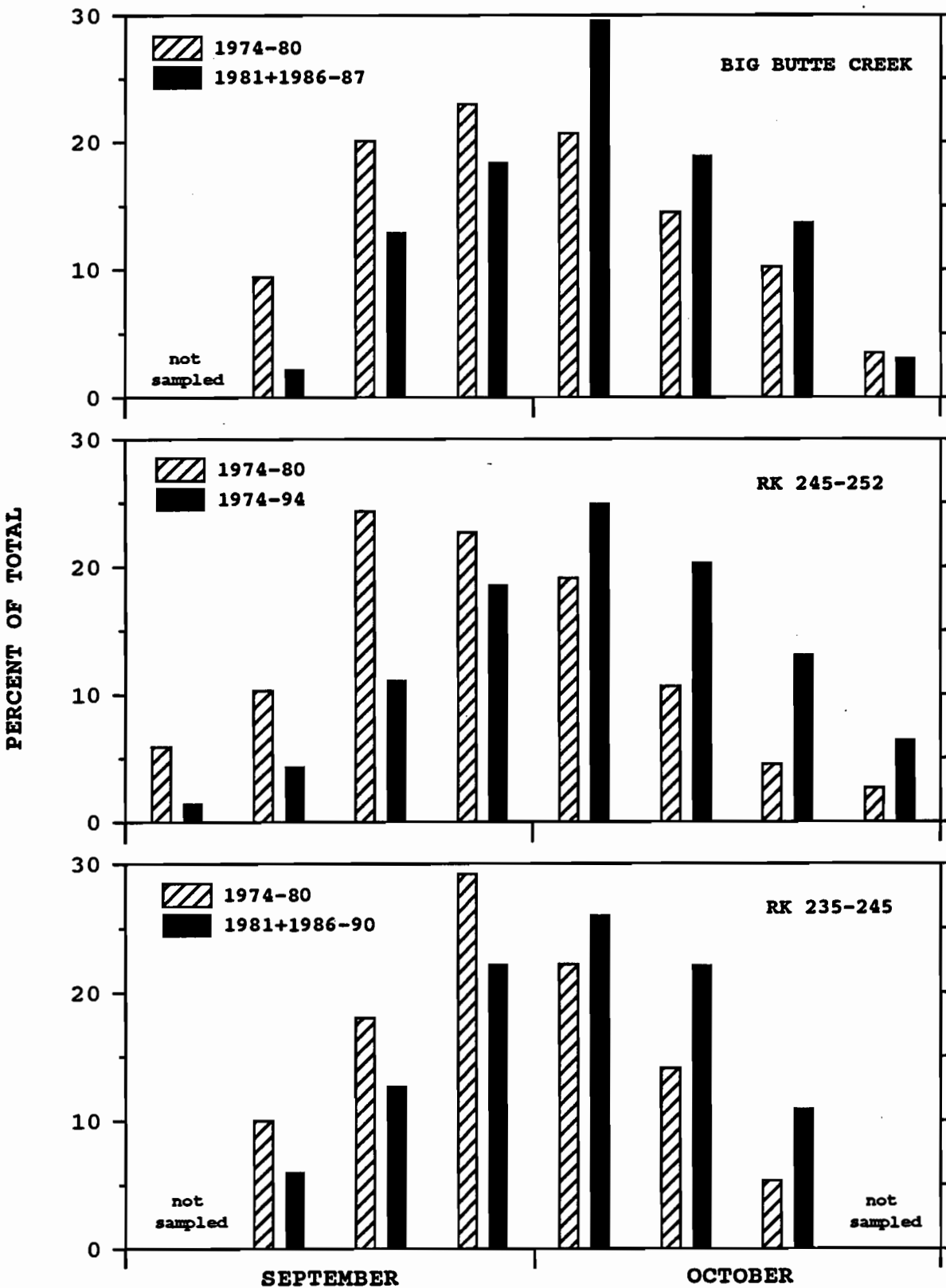

Figure 57. Estimated spawning time of female spring chinook salmon produced before and during reservoir operation. Fish produced before reservoir operation were assumed to dominate spawners until 1981.

We found that the mean date that unmarked females spawned between Cole M. Rivers Hatchery and Rogue Elk Park did not differ ( $P = 0.600$ ) in 1981-87 as compared to 1988-94. Mean dates of spawning averaged 6 October in 1981-87 and averaged 7 October in 1988-94. These results indicated that releases of colder water in September and October of 1984-90 failed to restore the historic spawning time of spring chinook salmon in the upper river, possibly because fry continued to emerge earlier than in preimpoundment years (see Emergence Timing, page 64).

We also found that the unmarked females from all postimpoundment broods spawned later than preimpoundment broods for spring chinook salmon that spawned in the Rogue River and in Big Butte Creek (Table 68). However, we found no significant change in the spawning time of females at Cole M. Rivers Hatchery. The median date of spawning at the hatchery averaged 5 October (95% CI = +3 days) in 1975-80 and averaged 3 October (95% CI = +2 days) in 1981-94. The difference of 2 days was not significant ( $t = 1.80$ ,  $P = 0.089$ ). Data included in these analyses are in Appendix Table E-116.

Because the spawning time of wild fish changed, without a simultaneous change in the spawning time of hatchery fish, we concluded that environmental conditions proximal to spawning were not responsible for the change in spawning time of wild fish. Later spawning by broods produced in postimpoundment years suggested that there was a change in the genetic composition of wild spring chinook salmon. Changes in survival rates of juveniles or adults may affected the genetic composition of the stock with resultant changes in life history characteristics. Selective breeding practices among hatchery stocks is a good example of such a mechanism (Larkin 1981; Leider et al. 1986).

We hypothesized that river physical factors during spawning, water temperature when the fish incubated in the gravel as eggs and alevins, the relative abundance of fall chinook salmon among the spawners, and the spawning date of female spring chinook salmon held at Cole M. Rivers Hatchery were the primary determiners of the spawning time of female spring chinook salmon.

Table 68. Comparisons of the mean date of spawning by unmarked female spring chinook salmon produced before and after the operation of Lost Creek Dam. Means were compared with a t-test.

Survey area	Mean date of spawning		P for difference
	Preimpoundment broods	Postimpoundment broods	
RK 245-252	09/29 <sup>a</sup>	10/06 <sup>b</sup>	<0.001
RK 235-245	09/29 <sup>a</sup>	10/06 <sup>c</sup>	<0.001
Big Butte Creek	10/01 <sup>a</sup>	10/09 <sup>d</sup>	0.003

<sup>a</sup> Includes fish that spawned in 1974-80.

<sup>b</sup> Includes fish that spawned in 1981-94.

<sup>c</sup> Includes fish that spawned in 1981 and in 1986-90.

<sup>d</sup> Includes fish that spawned in 1974 and in 1986-87.

We found that the mean date of spawning in the area between Cole M. Rivers Hatchery and Rogue Elk Park was positively related to water temperature four years earlier (Figure 58). A regression analysis (Appendix Table E-117) suggested that females spawned an average of 2 days later for each additional 1°C increase in water temperature in autumn and early winter. Mean water temperatures during this period ranged between 4.6°C and 8.8°C annually.

Residual variation from the relationship of spawning time and incubation temperature was negatively related to river temperature averaged for the spawning period (Figure 58). A regression analysis (Appendix Table E-117) suggested that females spawned an average of 1.4 days later for each additional 1°C decrease in water temperature during the spawning period. Mean water temperatures during spawning ranged between 8.0°C and 12.9°C annually.

The remaining residual variation in spawning time was positively related to the proportion of fall chinook salmon among all spawners in the area upstream of Gold Ray Dam (Figure 58). This relationship suggested that females recovered in the area immediately downstream of Lost Creek Dam spawned later in years when fall chinook salmon accounted for a high proportion of the spawners. However, the results of the tagging studies indicated that few fall chinook salmon spawned in the area immediately downstream of Lost Creek Dam. The relationship between observed and predicted estimates of mean date of spawning are also presented in Figure 58.

Results of the multiple regression must be interpreted with caution. Inclusion of 3 independent variables may be excessive for a regression analysis with 21 years of data. However, we have some confidence in the results because the effects of each independent variable on salmonid production is documented in the literature, and the independent variables in the regression were not intercorrelated. A correlation matrix that outlines the relationships among all variables is in Appendix Table E-118. Data included in the analysis are in Appendix Table E-119.

Analyses of tag recoveries indicated that spawning time correlated positively with migration time at Gold Ray Dam (Table 69). Early migrants

Table 69. Regressions of calendar day of tag recovery (Y) on calendar day of tagging (X) for chinook salmon tagged at Gold Ray Dam and recovered as spawned carcasses. Day-of-year calendar is in APPENDIX A.

Year	Regression	SE of slope	N	r	P
1974	$Y = 238.3 + 0.282X$	0.112	60	0.31	0.014
1975	$Y = 217.4 + 0.391X$	0.068	32	0.72	<0.001
1976	$Y = 238.4 + 0.260X$	0.039	50	0.70	<0.001
1977	$Y = 259.6 + 0.178X$	0.028	10	0.91	<0.001
1978	$Y = 252.3 + 0.189X$	0.026	126	0.55	<0.001
1986	$Y = 272.9 + 0.098X$	0.020	111	0.42	<0.001
1987	$Y = 272.4 + 0.114X$	0.019	171	0.42	<0.001

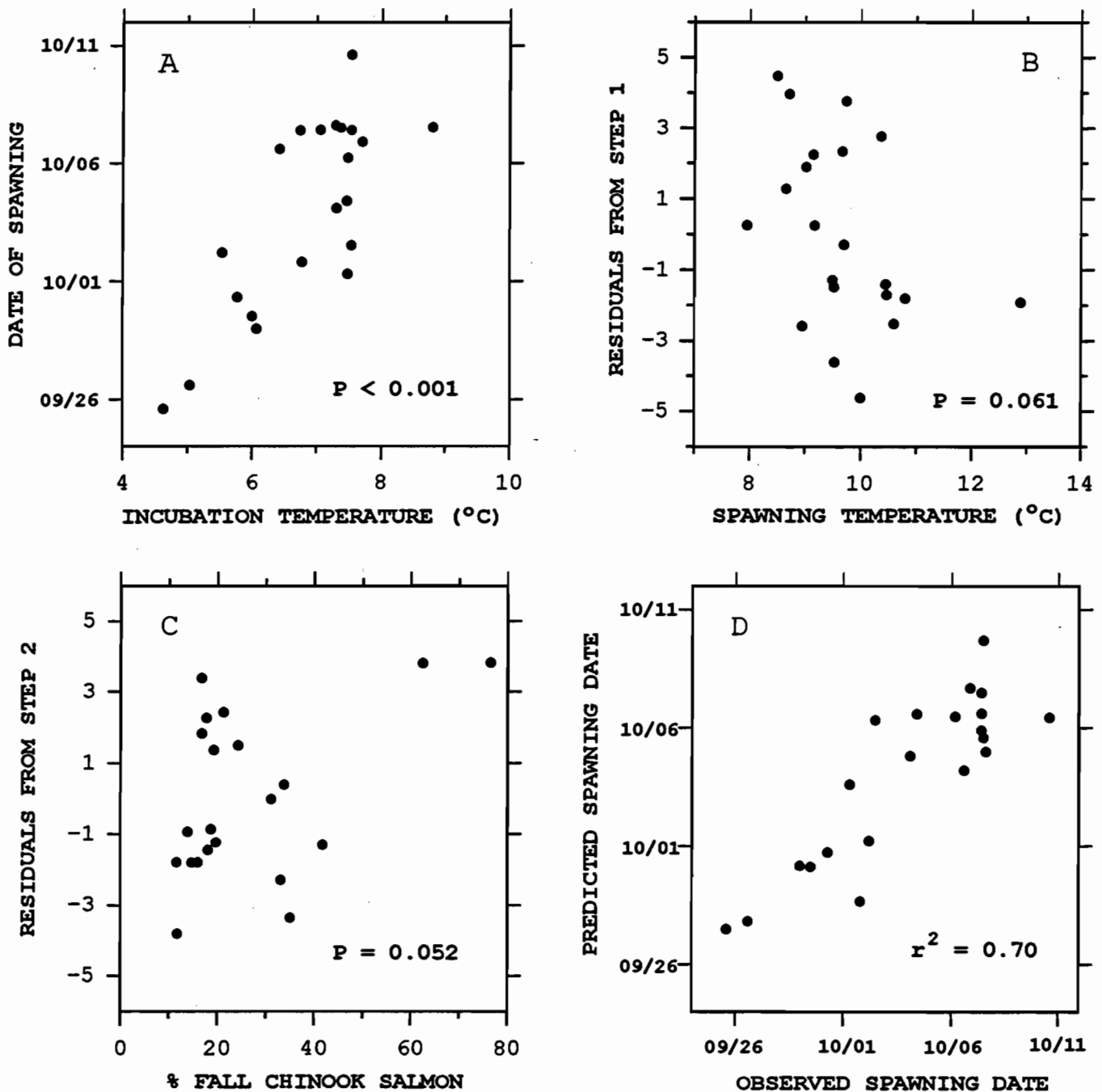

Figure 58. Steps in the analysis of factors related to the spawning time of female chinook salmon in the area between Cole M. Rivers Hatchery and Rogue Elk Park, 1974-94. Variables within plots are (A) estimated mean date of spawning, and mean maximum water temperature near McLeod four years earlier during October-December, (B) residual variation from relationship (A) and mean maximum water temperature near McLeod in the preceding September-October, and (C) residual variation from relationship (B) and the estimated abundance of fall chinook salmon among female chinook salmon that passed Gold Ray Dam. Plot D compares values predicted from the regression with observed values.

tended to spawn early, while late migrants tended to spawn later. Regressions of spawning time on migration time were significant for each year (Table 69).

Regressions of spawning time on migration time did not differ ( $P = 0.075$  for slopes and  $0.125$  for elevations) among preimpoundment broods. Also, regressions of spawning time on migration time did not differ ( $P = 0.57$  for slopes and  $0.170$  for elevations) among postimpoundment broods. Consequently, we pooled data from 1974-78 to represent preimpoundment broods and pooled data from 1986-87 to represent postimpoundment broods.

We found that the relationship between spawning time and migration time changed after operation of Lost Creek Dam. Slopes of pooled preimpoundment and postimpoundment regressions differed significantly (Table 70). To make these findings easier to interpret, we used preimpoundment and postimpoundment regressions to predict the mean date of carcass recovery for spring chinook salmon that passed Gold Ray Dam on four different dates.

Results indicated that the spawning time changed for spring chinook salmon that passed Gold Ray Dam in May-July (Figure 59). Spawning time did not change for adults that migrated during late July and August. The change in spawning time was most evident among early migrants. We estimated that among adults that passed Gold Ray Dam on 1 May, postimpoundment broods spawned an average of 12 days later compared with preimpoundment broods. In contrast, among adults that migrated on 1 July, the regressions predicted that postimpoundment broods spawned an average of 5 days later than preimpoundment broods. These changes caused the temporal disparity in spawning time between early and late migrating adults to be less among postimpoundment broods than preimpoundment broods (Figure 59).

We believe that decreased survival rates among the progeny of early migrants probably resulted in a later time of spawning among cohorts that survived to spawn. This conclusion was based on the finding that early migrants spawned earlier than late migrants. The decrease in the relative abundance of early migrants resulted in an increase in the relative abundance of late migrants that spawned later.

If the earlier emergence time (see Emergence Timing, page 64) of fry decreased fry production, the effect would be greatest on the progeny of early spawners. A lower rate of survival among progeny of early spawning parents

Table 70. Regressions of calendar day of carcass recovery (Y) and calendar day of passage at Gold Ray Dam (X) for chinook salmon, preimpoundment broods (1974-78 returns) compared with postimpoundment broods (1986-87 returns). Day-of-year calendar is in APPENDIX A.

Years	N	Regression	SE of slope	r	P for difference	
					Elevations	Slopes
1974-78	278	$Y = 246.6 + 0.221X$	0.018	0.59	<0.001	<0.001
1986-87	282	$Y = 273.3 + 0.104X$	0.014	0.41		



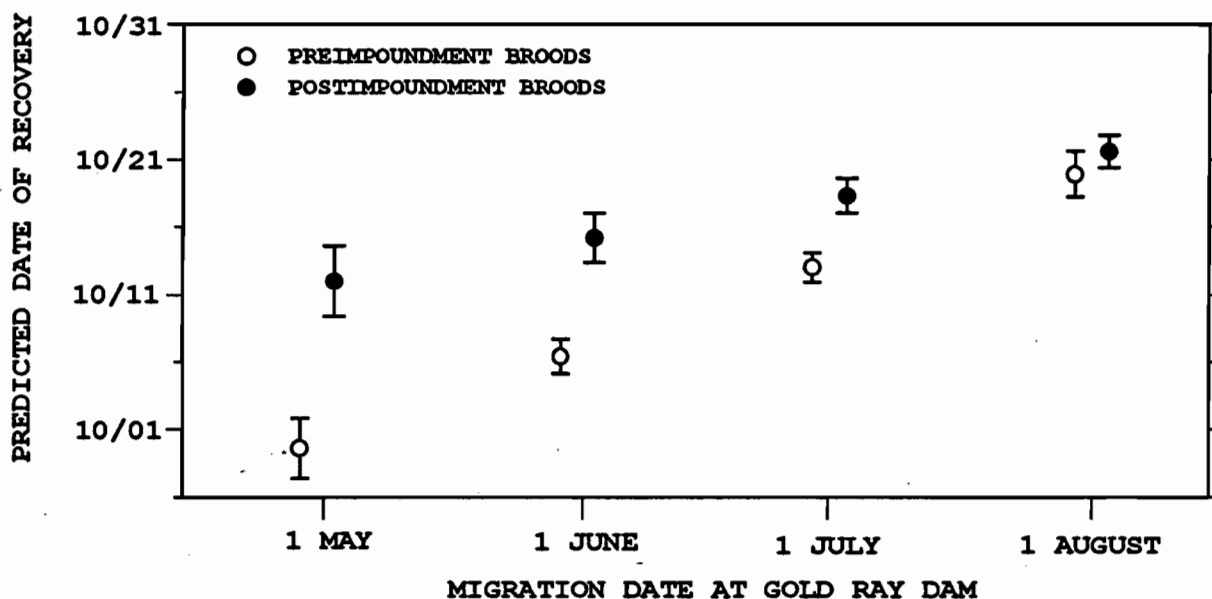

Figure 59. Predicted mean date of carcass recovery for spring chinook salmon that passed Gold Ray Dam on 5 dates during the migration period. Brackets represent 95% confidence intervals associated with the predicted values.

would be reflected in a later time of spawning among adults that survived to spawn, as we observed. Taylor (1980) found that the spawning time of pink salmon was highly heritable. Progeny of early spawning parents spawned earlier than the progeny of later spawning parents. Gall et al. (1988) reported comparable findings for rainbow trout. The time of maturation in Pacific salmon appears to be primarily a genetically based response to the amount of daylight hours. Alteration of the photoperiod changed the spawning time of spring chinook salmon held in a hatchery (Zaugg et al. 1986).

If early emergence decreased the production of spring chinook salmon fry in the Rogue River, the effect would have been greatest near Lost Creek Dam. Simulations of water temperature by the USACE indicated that the operation of Lost Creek Dam increased mean water temperature in November-January of 1978-86 by an average of 2.0°C at RK 248 and by an average of 1.3°C at RK 202. Resultant differences in juvenile production may have caused subsequent spatial and temporal differences in the number of cohorts that survived to spawn. Precise homing to natal areas is characteristic of Pacific salmon (Ricker 1972; Horrall 1981; Tallman and Healey 1991).

Many researchers have hypothesized that the varied spawning time among stocks of Pacific salmon is a genetically based adaptation to localized regimes of water temperature during the period that eggs and alevins incubate in the gravel (Bams 1969; Ricker 1972; Godin 1981; Miller and Brannon 1981; Burger et al. 1985; Heggberget 1988). Assuming that this hypothesis is true, then later spawning by spring chinook salmon in the Rogue River would compensate for the early emergence of fry caused by increased water temperature during the time that eggs and alevins incubate in the gravel. Because the increase in water temperature diminished with distance downstream, one would expect that any change in spawning time would also diminish with distance downstream, which is what we observed in this study.

## Freshwater Fisheries

Spring chinook salmon support an intensive recreational fishery in the Rogue River. Angler effort is most concentrated in the lower river near Gold Beach, in the middle river downstream of Savage Rapids Dam, and in areas upstream of Gold Ray Dam.

### Angler Effort

Angler effort in the lower river peaked in late April or early May for bank anglers and peaked in May for boat anglers (Figure 60). Effort by boat anglers in the middle river peaked in late May. Angler effort in areas upstream of Gold Ray Dam peaked in June (Figure 60).

Angling methods in the lower river fishery changed through time. In the 1960s, boat counts exceeded counts of bank anglers. However, by the late 1970s, counts of bank anglers exceeded the counts of boats (Appendix Table F-1). Based on this finding, we concluded that effort data from the 1960s should be excluded from further analysis, which left 1977 as the only year of preimpoundment data. Consequently, we chose not to compare indexes of angler effort before and after reservoir operation.

Fish abundance and flow appeared to be important determiners of angler effort for spring chinook salmon in the lower river. We found that mean weekly counts of bank anglers at 1000 hours were positively related to estimates of fish abundance, and that the resulting residual variation was positively related to flow (Appendix Table F-2). The two independent variables accounted for 55% of the variation in the counts of bank anglers. These findings indicated that angler effort for spring chinook salmon increased in years of greater water yield. Data included in the analysis are in Appendix Table F-3. A correlation matrix that outlines the relationships among all variables examined in the analysis is in Appendix Table F-4.

Analysis of boat counts produced results similar to the results from the analysis of bank angler counts. We found that mean weekly counts of boats at 1000 hours were positively related to estimates of fish abundance, flow, and water temperature (Appendix Table F-5). The three independent variables accounted for 51% of the variation in boat counts. These findings also indicated that anglers in the lower river increased effort for spring chinook salmon in years of greater water yield. Data included in the analysis are in Appendix Table F-3. A correlation matrix that outlines the relationships among all variables examined in the analysis is in Appendix Table F-4.

We estimated the effects of reservoir operation by using the regressions to predict indexes of angler effort under estimates of regulated and unregulated flows during the fishery. Values of other independent variables were set to average. Results from USACE simulation analyses indicated that flow at Agness from 2 April to 10 June in 1978-86 averaged 5,921 cfs for regulated conditions and 6,317 cfs for unregulated conditions. Substitution of these values into the regressions in Appendix Tables F-2 and F-5 suggested that operation of USACE reservoirs reduced bank angler effort by 10% and reduced boat angler effort by 2% in the RK 5-28 fishery for spring chinook salmon.

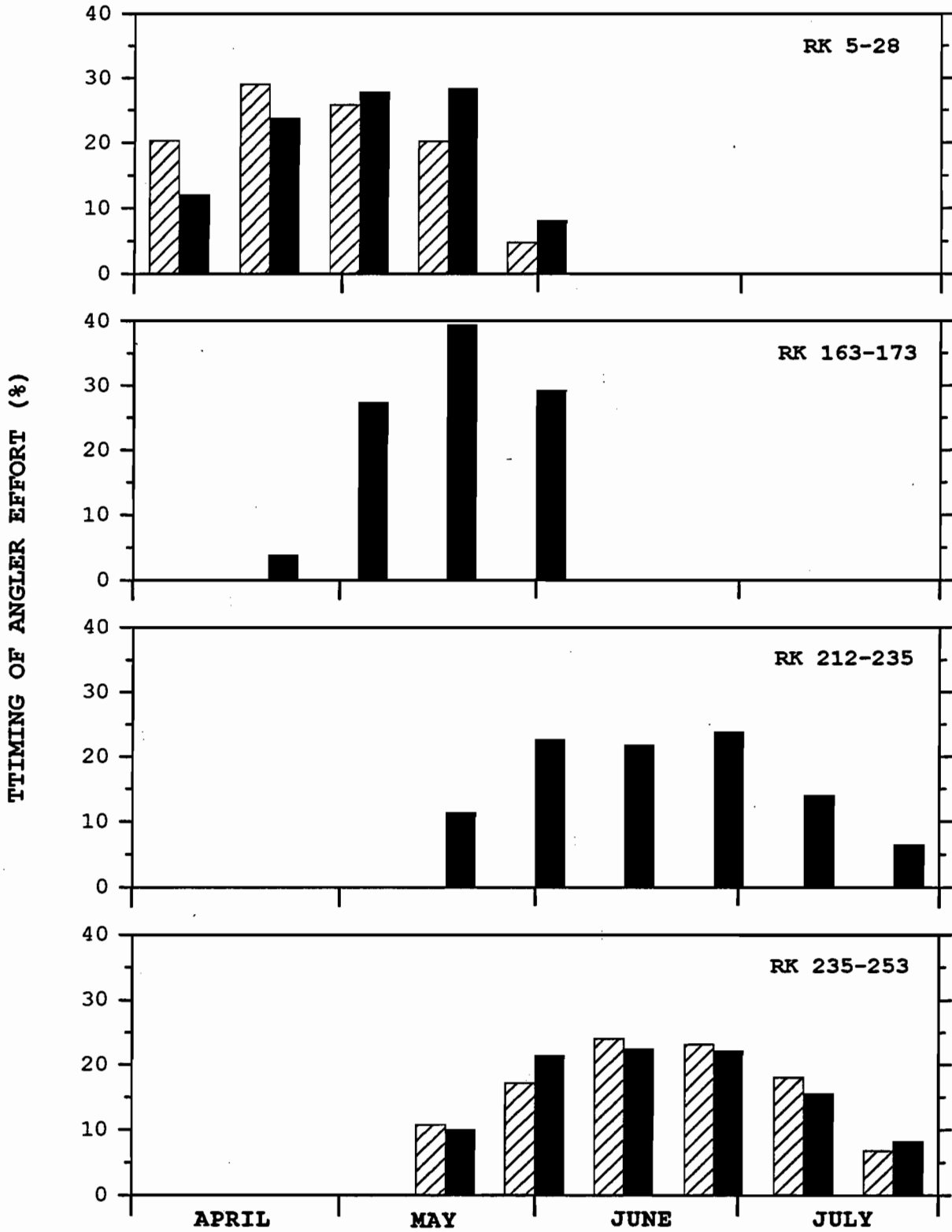

Figure 60. Timing of angler effort in four survey areas of the Rogue River, 1977-83. Lined bars reflect counts of bank anglers while solid bars reflect counts of boats or boat trailers. Surveyors counted few bank anglers in the RK 163-173 or in the RK 212-235 survey areas.

In the upper river, angler effort for spring chinook salmon appeared to be primarily affected by fish abundance and appeared to be less affected by variations in river physical factors. We found that the mean weekly counts of boat trailers in the survey area downstream of Shady Cove were positively related to estimates of the number of spring chinook salmon present in the area (Appendix Table F-6). Fish abundance, transformed to natural logarithms, accounted for 23% of the variation in the counts of boat trailers. Residual variation from the relationship was not significantly related to flow, water temperature, or turbidity.

Examination of the data indicated that boat trailer counts were related to fish abundance in a curvilinear manner. Trailer counts increased sharply as the estimated number of spring chinook salmon in the area increased from 0 to 10,000 fish (Figure 61). However, trailer counts did not appear to increase when estimates of fish abundance increased from 10,000 to 30,000 spring chinook salmon (Figure 61). Data included in the analysis are in Appendix Table F-7. A correlation matrix that outlines the relationships among all variables examined in the analysis is in Appendix Table F-8.

In the area upstream of Shady Cove, fish abundance also appeared to be a primary determiner of angler effort while river physical factors appeared to be of lesser importance. We found that the mean weekly counts of boats in 1977-81 were positively related to estimates of the number of spring chinook salmon in the area (Appendix Table F-9). Fish abundance, transformed to natural logarithms, accounted for 39% of the variation in the boat counts. Residual variation from the relationship was negatively related to turbidity. Turbidity accounted for another 10% of the variation in mean weekly boat counts. Flow and water temperature were not significantly related to the weekly indexes of boat angler effort.

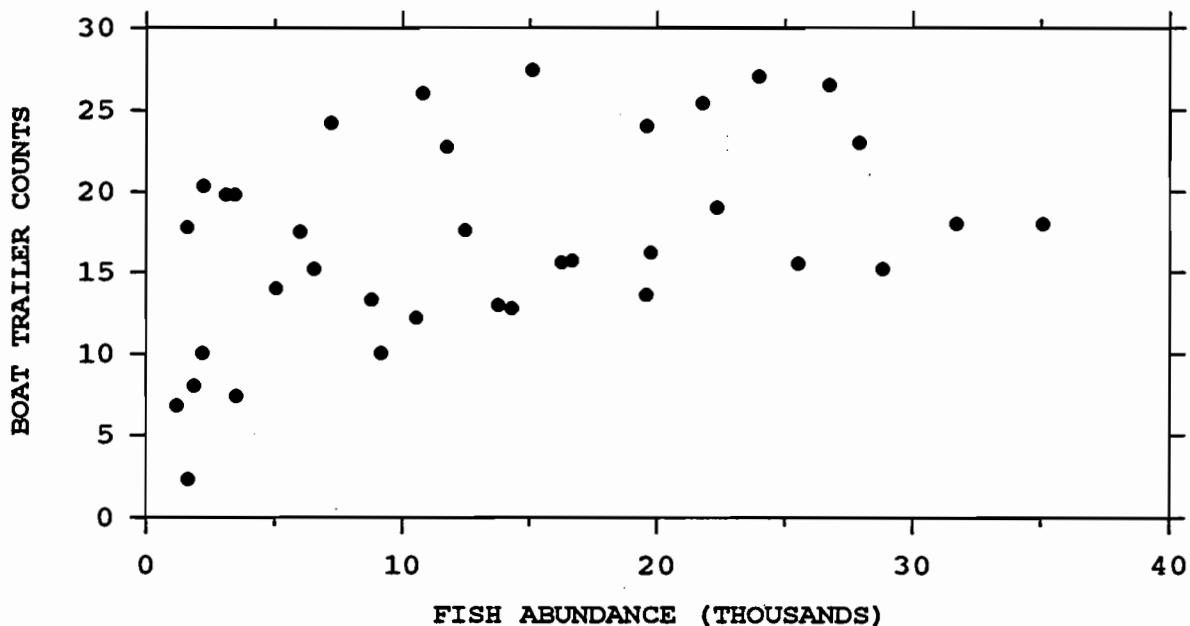

Figure 61. Mean daily counts of boat trailers, averaged by week, in the RK 212-235 survey area as compared to the estimated number of spring chinook salmon present in the fishery during those weeks, 1978-81.

Examination of the data indicated that the boat counts were related to fish abundance in a curvilinear manner. Boat counts increased sharply as fish abundance increased from 0 to 5,000 (Figure 62). In contrast, boat counts did not appear to increase when fish abundance ranged from 5,000 to 25,000 (Figure 62). Data included in the analysis are in Appendix Table F-10. A correlation matrix that outlines the relationships among all variables examined in the analysis is in Appendix Table F-11.

Counts of bank anglers in the survey area upstream of Shady Cove also suggested that fish abundance was a more important determiner of effort as compared with river physical factors. We found that the mean weekly counts of bank anglers in 1977-81 were positively related to estimates of the number of spring chinook salmon present in the area (Appendix Table F-12). Fish abundance accounted for 52% of the variation in numbers of bank anglers. Residual variation from the relationship was not significantly related to flow, water temperature, or turbidity.

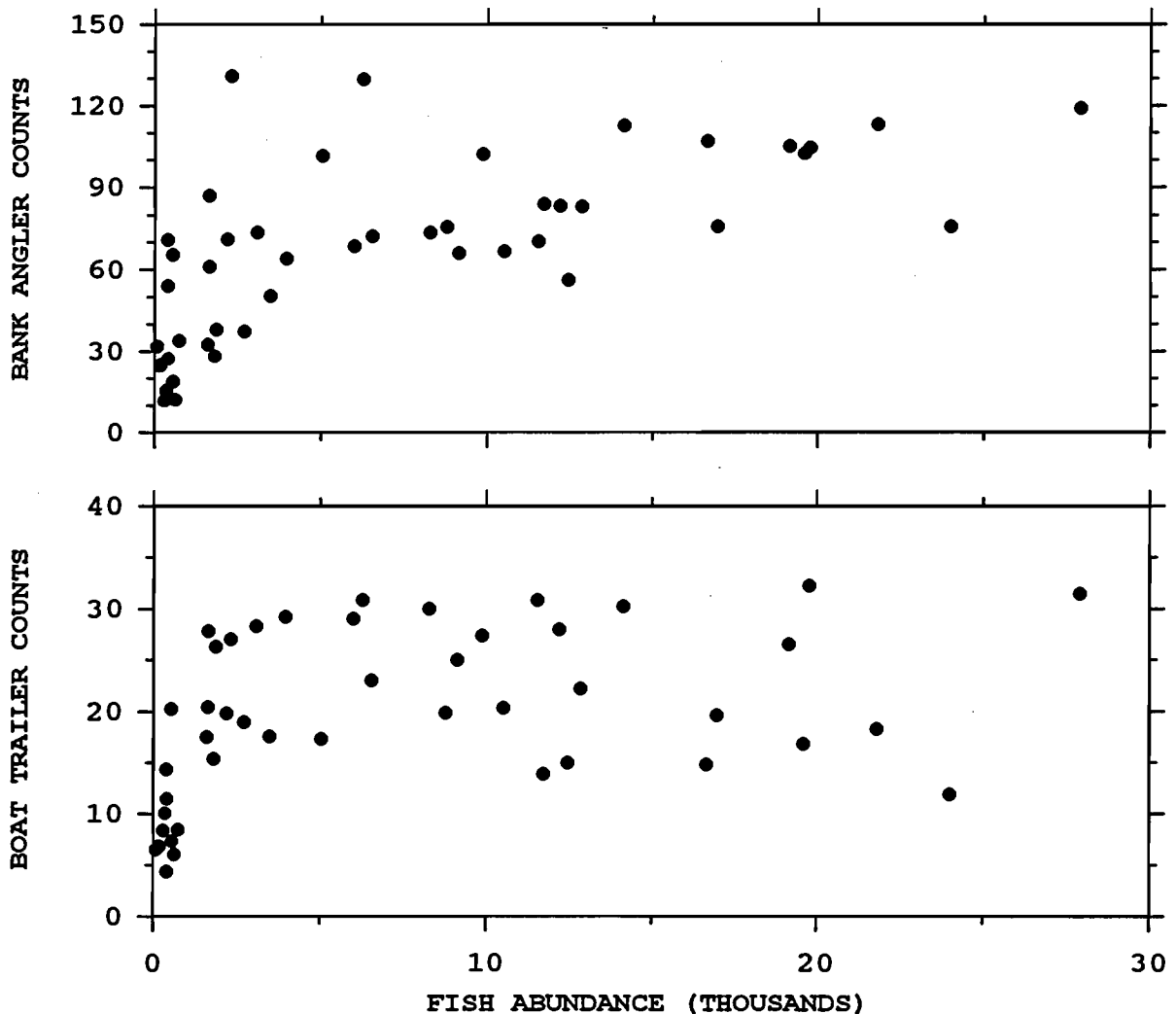

Figure 62. Mean daily counts of bank anglers and boat trailers, averaged by week, in the RK 235-253 survey area as compared to the estimated number of spring chinook salmon present in the fishery during those weeks, 1977-81.

Examination of the data indicated that bank angler counts were possibly related to fish abundance in a curvilinear manner. As with the boat counts, counts of bank anglers increased rapidly as the number of fish increased from 0 to 5,000, but bank angler counts increased more slowly as the number of fish increased from 5,000 to 25,000 (Figure 62). Data included in the analysis are in Appendix Table F-10. A correlation matrix that outlines the relationships among all variables examined in the analysis is in Appendix Table F-11.

The relationships between the abundance of spring chinook salmon and angler effort in the upper river appear to indicate that effort in the fishery may often be limited by the availability of appropriate fishing sites for salmon rather than by fish abundance. If this conclusion is true, then attempts to enhance the fishery upstream of Gold Ray Dam by increasing the number of spring chinook salmon will not result in commensurate increases in recreational opportunities as measured by angler days of effort.

We found that angler effort in the lower river was affected by the abundance of spring chinook salmon and by river physical factors. We also found that fish abundance affected angler effort in the upper river. These findings suggested that reservoir operation directly affected angler effort for spring chinook salmon through impacts on the production of wild fish and through changes in water temperature, which affected the time that spring chinook salmon migrated through the fisheries (see Migration Timing, page 157).

### Catch Rate

Annual catch rates of spring chinook salmon in the fishery near Gold Beach in 1965-81 ranged between 0.0038 fish per hour and 0.0226 fish per hour for bank anglers and ranged between 0.0115 fish per hour and 0.0490 fish per hour for boat anglers (Appendix Table F-13). Annual catch rates in the boat fishery downstream of Savage Rapids Dam were 0.0689 fish per hour in 1982 and 0.0344 fish per hour in 1983. Annual catch rates in the boat fishery between Shady Cove and Gold Ray Dam ranged between 0.0358 fish per hour and 0.0889 fish per hour in 1978-81. Annual catch rates in the fishery between Cole M. Rivers Hatchery and Shady Cove in 1977-81 ranged between 0.0258 fish per hour and 0.0303 fish per hour for bank anglers and ranged between 0.0315 fish per hour and 0.0604 fish per hour for boat anglers (Appendix Table F-13).

In 1977-81, anglers who fished in the upper river caught spring chinook salmon at a greater rate than anglers who fished in the lower river. Annual catch rates averaged 0.0288 fish per hour for bank anglers who fished upstream of Shady Cove and 0.0101 fish per hour for bank anglers who fished near Gold Beach. A paired t-test indicated that the means differed significantly ( $P = 0.011$ ). Among boat anglers, annual catch rates averaged 0.0444 fish per hour for those who fished upstream of Shady Cove and 0.0211 fish per hour for those who fished near Gold Beach. A paired t-test indicated that these means also differed significantly ( $P = 0.008$ ).

Differences in migration rates of spring chinook salmon may account for the spatial differences in angler catch rates. We found that adult fish migrated faster through the lower river than through the upper river (see Migration Rate, page 156). We suspect that adult spring chinook salmon, particularly wild fish, held in deep pools in the upper river where they were

exposed to continuous angling during the fishery. In the lower river, spring chinook salmon probably spent less time at specific sites and moved through the fishery at faster rates.

Anglers who fished from boats caught spring chinook salmon at greater rates than anglers who fished from the bank. In the fishery near Gold Beach during 1965-81, annual catch rates of boat anglers averaged 0.0177 more fish per hour than annual catch rates of bank anglers. A paired t-test indicated that the difference in means was significant ( $P < 0.001$ ). In the fishery upstream of Shady Cove in 1977-81, the annual catch rates of boat anglers averaged 0.092 more fish per hour than the annual catch rates of bank anglers. A paired t-test indicated that these means also differed significantly ( $P = 0.049$ ). Based on these findings, we separately analyzed catch rate estimates for bank and boat anglers. Data included in these analyses are in Appendix Table F-13.

We found that the annual catch rates of spring chinook salmon in the fishery near Gold Beach did not differ significantly before and after operation of Lost Creek Dam. Catch rates in the bank fishery averaged 0.0095 fish per hour in 1966-77 and 0.0104 fish per hour in 1978-81 ( $P$  for difference = 0.794). A sensitivity analysis indicated that catch rates would have had to change by 0.0067 fish per hour to be detected at the 95% confidence level. Among boat anglers, catch rates averaged 0.0300 fish per hour in 1965-77 and 0.0205 fish per hour in 1978-81 ( $P$  for difference = 0.109). A sensitivity analysis indicated catch rates would have had to change by 0.0146 fish per hour to be detected at the 95% confidence level. Data included in these analyses are in Appendix Table F-13. Catch rates of spring chinook salmon in fisheries located farther upstream were not compared because catch rates were estimated in only one year before reservoir operation.

Analysis of annual catch rates of spring chinook salmon by anglers who fished the lower river suggested that flow and fish abundance were primary determiners of angler success. We did not include water temperature in the regression analyses because water temperature was highly correlated with flow ( $P < 0.001$ ). In addition, we excluded jacks from the analyses because few jacks are caught in the lower river fishery for spring chinook salmon (see *Catch Composition*, page 190).

We found that flow during the fishery accounted for 32% of the variation in annual catch rates by bank anglers in 1965-81 (Appendix Table F-14). Residual variation from the relationship was not significantly related to (1) the estimated freshwater returns of spring chinook salmon, (2) migration timing at Gold Ray Dam, or (3) the percentage of hatchery fish in the returns.

We also found that fish abundance and the percentage of hatchery fish in the returns accounted for 41% of the variation in annual catch rates by boat anglers who fished the lower river in 1965-81 (Appendix Table F-15). Residual variation from the regression was not significantly related to flow during the fishery or to the migration timing of adult fish at Gold Ray Dam. Data included in the analyses of annual catch rates in the lower river fishery are in Appendix Table F-16. A correlation matrix that outlines the relationships between all of the variables examined in the analyses of annual catch rates is in Appendix Table F-17.

Weekly catch rates of spring chinook salmon in the fishery near Gold Beach were also related to fish abundance and river physical factors. Regression analyses of weekly catch rates in 1977-1981 indicated that angler success was positively related to fish abundance, flow, and water temperature (Appendix Tables F-18 and F-19). These factors accounted for 41% of the variation in catch rates by bank anglers and 33% of the variation in catch rates by boat anglers. Data included in the analyses are in Appendix Table F-3. A correlation matrix that outlines the relationships among all variables examined in the analyses are in Appendix Table F-4.

Angler catch rates of spring chinook salmon in the fisheries near Shady Cove were related to fish abundance and river physical factors. Regression analyses of weekly catch rates in 1977-1981 suggested that angler success in the upper river was affected primarily by fish abundance. In the fishery downstream of Shady Cove, catch rates of boat anglers were positively related to fish abundance and were negatively related to water temperature (Appendix Table F-20). These factors accounted for 74% of the variation in angler catch rates. Data included in the analyses are in Appendix Table F-7. A correlation matrix that outlines the relationships among all variables examined in the analyses are in Appendix Table F-8.

In the fishery upstream of Shady Cove, weekly catch rates of boat anglers were positively related to fish abundance (Appendix Table F-21), which accounted for 11% of the variation in catch rates. River physical factors were not significantly related to catch rates of boat anglers but were related to catch rates of bank anglers. Regression analysis indicated that catch rates from the bank were positively related to fish abundance and were negatively related to flow and turbidity (Appendix Table F-22). These variables accounted for 73% for the variation in catch rates of bank anglers. Data included in the analyses are in Appendix Table F-10. A correlation matrix that outlines the relationships among all variables examined in the analyses are in Appendix Table F-11.

We found that angler catch rates of spring chinook salmon in the lower river and in the upper river were affected by the abundance of spring chinook salmon and by river physical factors. Similar to results reported by Peterman and Steer (1981), we found that angler catch rates do not necessarily vary in direct proportion to the abundance of spring chinook salmon. Our findings also suggested that reservoir operation directly affected angler effort for spring chinook salmon through impacts on fish production and through changes in water temperature, which affected the time that spring chinook salmon migrated through the fisheries (see Migration Timing, page 157). In addition, our results suggested that reservoir operations also appeared to affect angler catch rates through changes in river physical factors, primarily through changes in flow.

### Timing of Angler Catch

Counts of salmon taken to canneries near Gold Beach in 1950-64 indicated that most spring chinook salmon were caught in the lower river during April and May (Figure 63). Harvest peaked, on average, in the first week of May. We found a bimodal distribution in the cannery counts that probably reflected the difference in run timing between spring chinook salmon and fall



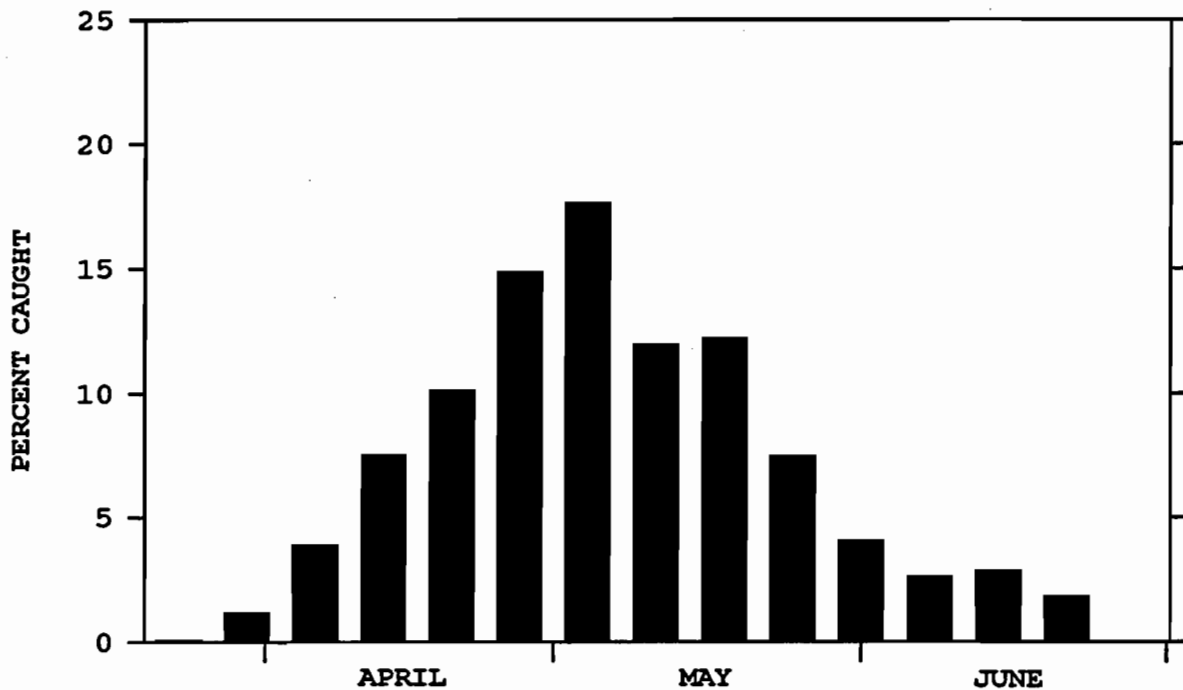

Figure 63. Mean harvest time of spring chinook salmon brought to canneries near Gold Beach, 1950-64.

chinook salmon. On average, the nadir in cannery counts occurred during the first week of July. Based on this finding, and the findings of ODFW (1992), we assumed that salmon delivered to the canneries prior to July were spring chinook salmon. Data included in this assessment are in Appendix Table F-23.

Angler surveys conducted in 1977-83 indicated that catches in the fisheries near Gold Beach and Grants Pass peaked in May, while catches in the fishery upstream of Gold Ray Dam peaked in June or July (Figure 64). We used estimates of catch timing from the cannery counts and the angler surveys to make decisions as to how to apportion catch estimates from salmon-steelhead cards to reflect angler harvest in areas upstream and downstream of Gold Ray Dam (see Harvest, page 192).

Results from angler surveys in 1977-83 showed that different types of spring chinook salmon differed in time of catch in the freshwater fisheries. Within each fishery, jacks smaller than 60 cm tended to be caught later than larger fish (Figure 64). Comparisons of the median day of capture indicated that unmarked jacks were captured an average of 7 to 12 days later than unmarked adults (Table 71). The difference in catch timing was commensurate with the difference in the migration timing of jacks and adults at Gold Ray Dam (see Migration Timing, page 157).

In contrast, we were unable to detect a significant difference in the time of capture of wild and hatchery fish. Anglers captured marked and unmarked adults at similar times, except that anglers caught few marked fish after the middle of July in the two fisheries surveyed upstream of Gold Ray Dam (Figure 64). Comparisons of the median day of capture revealed no significant differences between marked and unmarked adults (Table 71).

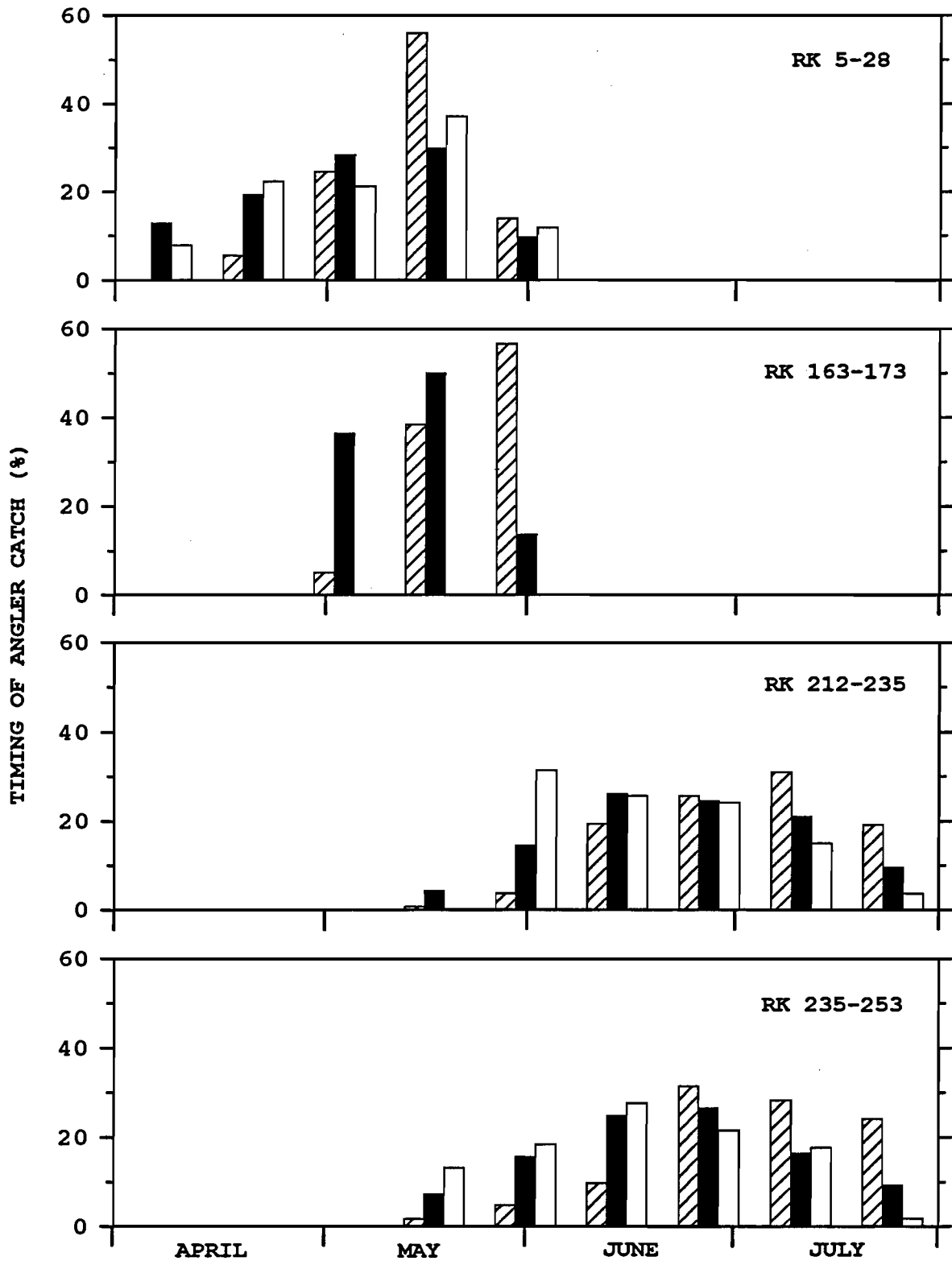

Figure 64. Mean harvest time of spring chinook salmon in four survey areas of the Rogue River, 1977-83. Lined bars reflect catches of unmarked jacks, solid bars reflect catches of unmarked adults, and open bars reflect catches of marked adults. Data includes only those fish examined by surveyors.

Table 71. Comparisons of the median dates of capture for marked and unmarked spring chinook salmon harvested in four areas of the Rogue River, 1977-83. Estimates include only those fish examined by survey personnel.

Fishery	Years	Mean of annual medians		Difference $\pm$ 95% CI
		Marked	Unmarked	
RK 5-28	1977-81	11 May	9 May	2 days $\pm$ 11 days
RK 163-173	1982-83	11 May	16 May	-5 days $\pm$ --
RK 212-235	1978-81	16 June	21 June	-5 days $\pm$ 13 days
RK 235-253	1977-81	19 June	23 June	-4 days $\pm$ 7 days

### Catch Composition

We found that the composition of the spring chinook salmon caught by anglers differed from the composition of fish that passed Gold Ray Dam. We also found that the composition of the angler catch differed among different fisheries in the river.

In three of five years, jacks composed a significantly greater percentage of the fish that passed Gold Ray Dam as compared to fish harvested in the lower river fishery (Table 72). In each of nine years, jacks also composed a greater percentage of the fish that passed Gold Ray Dam as compared to fish harvested by anglers who fished between Shady Cove and Cole M. Rivers Hatchery (Table 72). In contrast, in three of four years, jacks composed a greater percentage of fish landed between Shady Cove and Touvelle State Park as compared to fish that passed Gold Ray Dam (Table 72). Data included in these analyses are in Appendix Table F-24.

Older fish appear to compose the majority of the spring chinook salmon harvested in the lower river. Scale samples collected in 1967-71 indicated that age 4 fish dominated the harvest (Appendix Table F-25). Scale samples collected in 1979-81 also indicated that age 4 fish dominated the harvest, except in 1981 when age 3 and age 5 fish composed a large portion of the angler harvest (Appendix Table F-26).

Scale samples collected in the upper river during 1980-81 suggested that age 4 fish dominated the angler harvest in 1980, while age 5 fish dominated the angler harvest in 1981 (Appendix Table F-27). Scale samples also suggested that jacks composed a greater portion of the angler catch downstream of Shady Cove as compared to the area farther upstream (Appendix Table F-27). The age composition of the angler catch in the upper river during 1980-81 could not be directly compared to the age composition of the run because scales were not randomly taken from harvested fish. Harvest estimates of jacks and adult fish within each of the two survey areas are needed to make those specific comparisons.

However, survey clerks measured all spring chinook salmon seen during random surveys of anglers who fished upstream of Gold Ray Dam in 1987-90. In each of the four years, fish that ranged in length between 73 and 87 cm

Table 72. Relative abundance of jacks among spring chinook salmon harvested by anglers as compared to spring chinook salmon that passed Gold Ray Dam, 1977-90. Data includes only those fish examined by survey clerks.

Year	Fish harvested		% jacks at Gold Ray Dam
	% jacks	95% confidence interval	
RK 5-28			
1977	15.2	9.8-22.0	18.5
1978	8.6	4.6-14.3	24.0 <sup>a</sup>
1979	8.8	5.9-12.6	15.0 <sup>a</sup>
1980	0.0	0.0-11.9	21.4 <sup>a</sup>
1981	12.5	5.9-22.4	17.6
RK 212-235			
1978	41.4	37.4-45.7	24.0 <sup>a</sup>
1979	19.2	16.1-23.1	15.0 <sup>a</sup>
1980	40.2	36.2-45.8	21.4 <sup>a</sup>
1981	24.0	17.2-32.0	17.6
RK 223-235			
1987	13.9	7.2-23.5	19.9
1988	15.0	9.9-21.3	22.2 <sup>a</sup>
1989	13.8	6.1-25.4	10.9
1990	14.2	8.1-22.3	12.4
RK 235-253			
1977	13.9	11.2-17.0	18.5 <sup>a</sup>
1978	13.5	10.7-17.3	24.0 <sup>a</sup>
1979	3.2	1.8-5.2	15.0 <sup>a</sup>
1980	6.9	4.8-9.9	21.4 <sup>a</sup>
1981	8.4	6.1-11.0	17.6 <sup>a</sup>
1987	4.3	2.7-6.8	19.9 <sup>a</sup>
1988	3.4	2.2-4.8	22.2 <sup>a</sup>
1989	2.4	1.1-4.5	10.9 <sup>a</sup>
1990	6.2	4.0-9.0	12.4 <sup>a</sup>

<sup>a</sup> Value falls outside of 95% confidence interval for fish harvested by anglers.

predominated the angler catches (Appendix Table F-28). Spring chinook salmon in this size range tend to be mostly age 4 fish (see *Size at Maturity*, page 133). These findings, in conjunction with scales collected in 1980-81, suggest that spring chinook salmon are harvested in an age-selective manner in the upper river fishery as well as the lower river fishery (see *Fishery Selectivity*, page 198).

## Harvest

Estimates from salmon-steelhead cards indicated that anglers harvested an average of 6,915 large spring chinook salmon annually in the Rogue River during 1956-94. Annual estimates of harvest ranged between 1,602 in 1984 and 19,478 fish in 1988 (Appendix Tables F-29 through F-31). These catch estimates do not include small chinook salmon that anglers were not required to enter on salmon-steelhead cards (<51 cm in 1956-76 and <60 cm in 1977-1994).

**Harvest Downstream of Gold Ray Dam:** Estimates from salmon-steelhead cards indicated that anglers harvested an average of 4,038 large spring chinook salmon annually in the middle river and in the lower river during 1961-94. Harvest estimates ranged between 641 and 9,545 fish annually (Appendix Tables F-30 through F-32).

We found that angler harvest of large spring chinook salmon decreased after the operation of Lost Creek Dam. Catch estimates from salmon-steelhead cards averaged 4,648 fish in 1961-77 and averaged 3,429 fish in 1978-94. The means differed significantly at  $P = 0.066$ . We used regression analysis to evaluate whether changes in fish abundance or river physical factors accounted the change in harvest.

We hypothesized that five primary factors affected the annual number of spring chinook salmon harvested in the middle river and in the lower river: (1) fish abundance, (2) relative abundance of hatchery fish, (3) migration timing, (4) flow during the fishery, and (5) water temperature during the fishery. However, we excluded water temperature from the regression analysis because it was highly correlated with flow and because estimates were not available for 1988-94. A correlation matrix that outlines the relationships between all of the factors examined in the analysis is in Appendix Table F-33. Data included in the analysis are in Appendix Table F-34.

Fish abundance and flow appeared to be important determiners of the annual harvest of spring chinook salmon in areas downstream of Gold Ray Dam. Regression analysis indicated that these factors accounted for significant amounts of the variation in harvest estimates (Appendix Table F-35). Estimates of annual harvest were positively related to estimates of the number of adult spring chinook salmon that returned to freshwater (Figure 65). Residual variation from the relationship of harvest and freshwater returns was positively related to mean flow at Agness in April-May (Figure 65). The relationship between observed and predicted estimates of harvest are also presented in Figure 65.

Age-specific estimates of harvest for wild and hatchery spring chinook salmon landed in the fisheries downstream of Gold Ray Dam could only be estimated for 1979-81 because those were the only years when scale samples were collected from fish harvested by anglers. To estimate the total harvest downstream of Gold Ray Dam, we used the proportion of jacks seen in the harvest (Table 72) to expand the harvest estimate of large spring chinook salmon from the salmon-steelhead card estimate. We then used estimates of catch composition (Appendix Table F-26) to estimate the number of wild and hatchery fish harvested at each age (Appendix Table F-36).

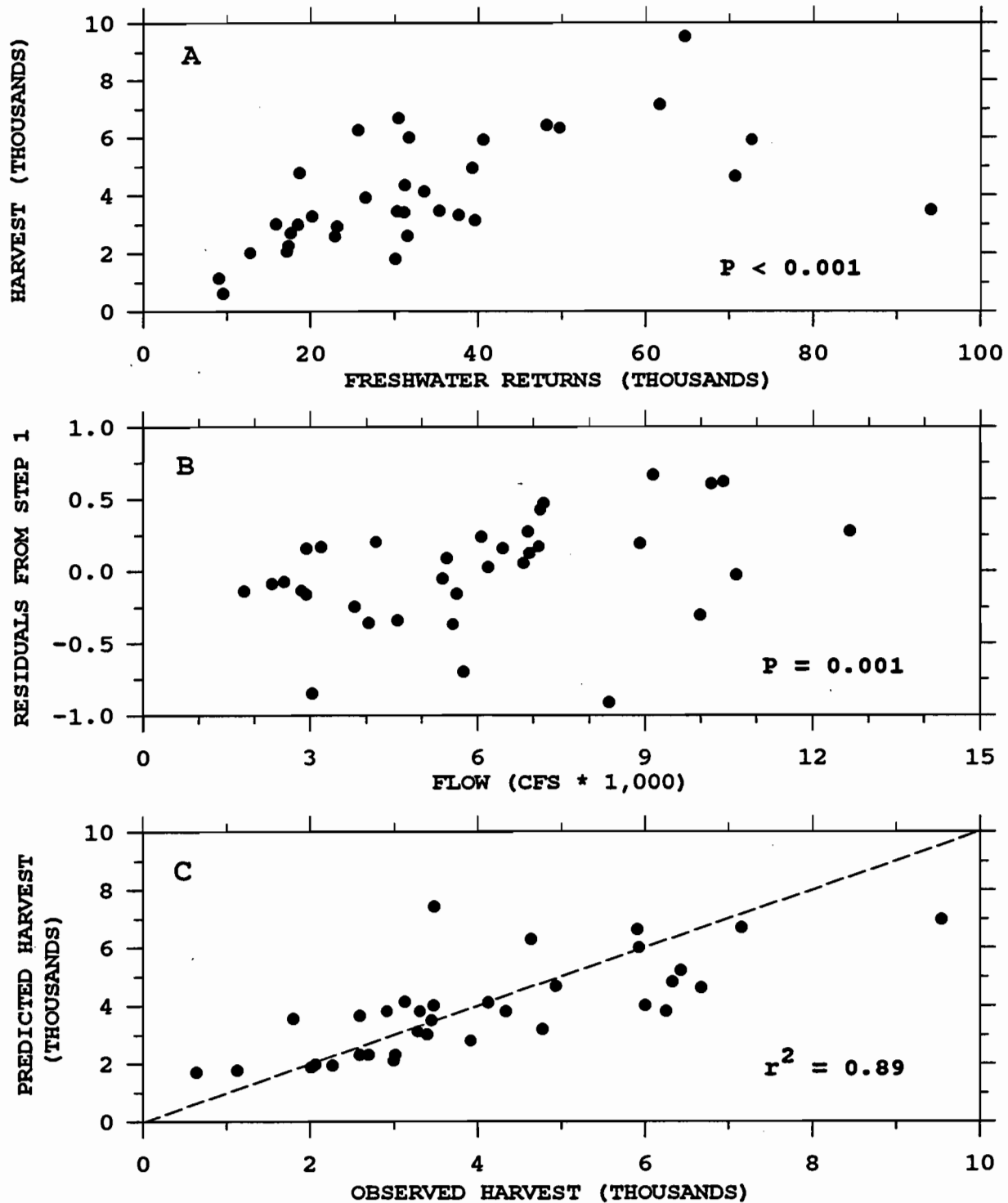

Figure 65. Steps in the analysis of factors related to the number of large spring chinook salmon harvested downstream of Gold Ray Dam, 1961-94. Variables within plots are (A) harvest estimates from salmon-steelhead cards and freshwater returns of spring chinook salmon, and (B) residual variation from relationship (A) and the mean flow at Agness in April-May. Plot C compares values predicted from the regression with observed values. None of the data include jacks.

Upstream of Gold Ray Dam: Estimates from salmon-steelhead cards indicated that anglers annually harvested an average of 4,046 large spring chinook salmon upstream of Gold Ray Dam in 1970-94. Harvest estimates ranged between 437 and 13,546 fish annually (Appendix Tables F-30, F-31, and F-37).

We did not compare harvest before and after the operation of Lost Creek Dam because the length of the fishing season increased three times in the 1970s. Instead, we used regression analysis to evaluate the effects of fish abundance, flow, and water temperature on harvest. We examined only data from 1978-94 because of the changes in the length of the fishing season in the 1970s and because hatchery fish accounted for less than 10% of the run prior to 1978.

Results indicated that fish abundance was the primary factor related to the number of spring chinook salmon harvested in the fishery upstream of Gold Ray Dam (Appendix Table F-38). Numbers of wild and hatchery fish that passed Gold Ray Dam accounted for 88% of the variation in the annual numbers of fish harvested farther upstream in 1978-94.

We found that annual estimates of harvest in the upper river were positively related to the number of wild fish that passed Gold Ray Dam, and that the residual variation was positively related to the number of hatchery fish that passed Gold Ray Dam (Figure 66). Flow and water temperature during the fishery were not related to the number of large spring chinook salmon harvested in the upper river (Appendix Table F-38). These findings indicate that fish abundance had a greater effect on angler harvest in the upper river as compared to river physical factors.

A regression analysis suggested that wild fish contributed to the angler harvest in the upper river at greater rates than hatchery fish. Regression coefficients (Appendix Table F-38) indicated that 194 (SE = +29) wild fish were harvested for every 1,000 that passed Gold Ray Dam and that 114 (SE = +27) hatchery fish were harvested for every 1,000 that passed Gold Ray Dam. Data included in the regression analysis are in Appendix Table F-39. A correlation matrix that outlines the relationships between all of the factors examined in the analysis are in Appendix Table F-40.

Age-specific estimates of harvest for wild and hatchery spring chinook salmon landed in the fisheries upstream of Gold Ray Dam could only be estimated for 1980-81 because those were the only years when scale samples were collected from fish harvested by anglers. However, scale samples were not randomly obtained from the fishery (see Freshwater Fisheries, page 48) we used incomplete angler survey data to estimate the number of jacks and adults harvested in each of the two survey areas upstream of Gold Ray Dam (Appendix Tables F-41 through F-47).

We found that the harvest estimates from the angler surveys were 69% (1980) and 53% (1981) of the estimates developed from salmon-steelhead cards (Appendix Table F-47), so we increased the harvest estimates of jacks accordingly. We used the adjusted harvest estimates for jacks, harvest estimates from salmon-steelhead cards, and estimates of age composition from scale analyses (Appendix Table F-27) to estimate the age-specific harvest of wild and hatchery spring chinook salmon landed upstream of Gold Ray Dam in 1980-81 (Appendix Table F-48).

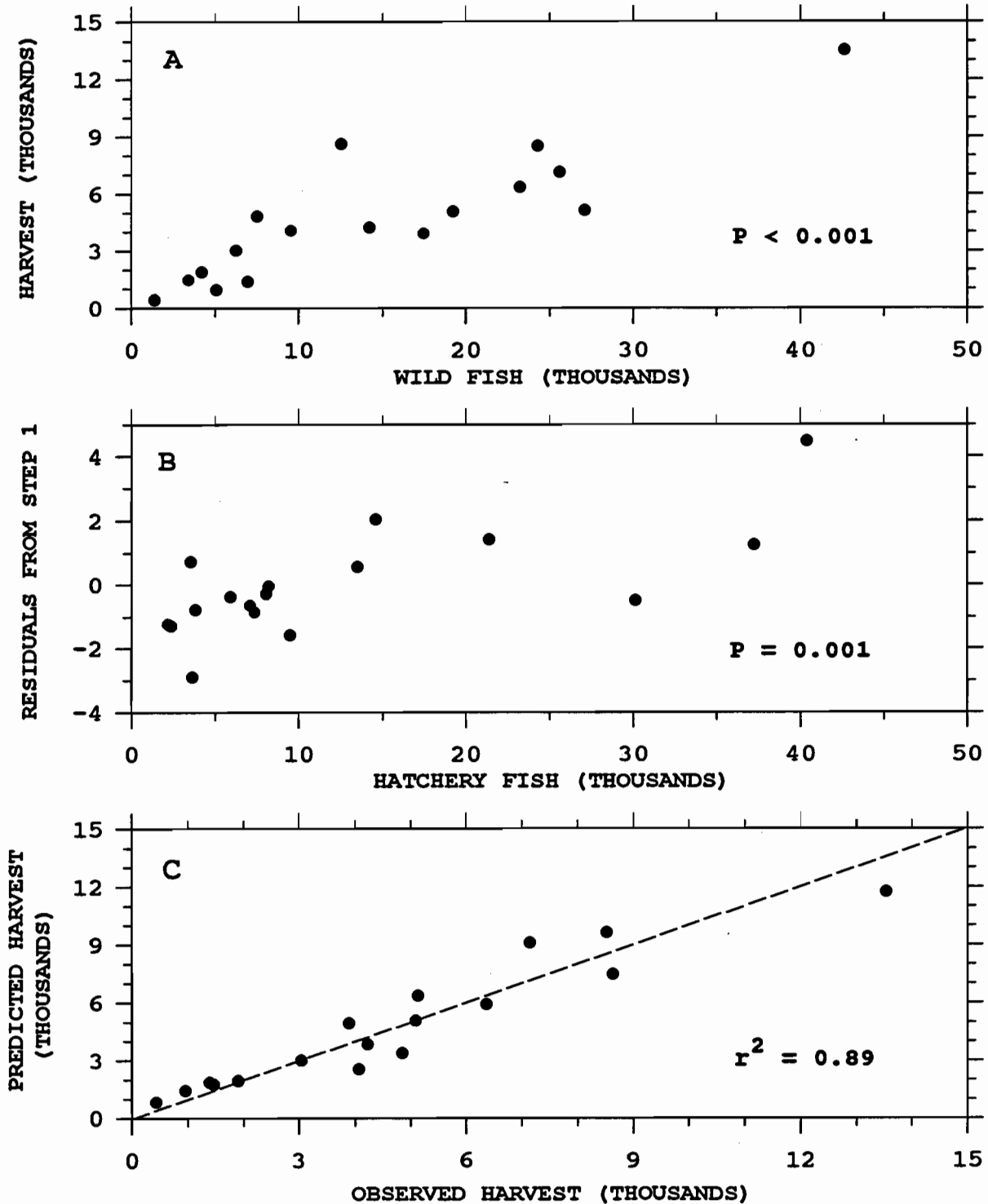

Figure 66. Steps in the analysis of factors related to the number of large spring chinook salmon harvested upstream of Gold Ray Dam, 1978-94. Variables within plots are (A) harvest estimates from salmon-steelhead cards and passage estimates of wild fish at Gold Ray Dam, and (B) residual variation from relationship (A) and passage estimates of hatchery fish at Gold Ray Dam. Plot C compares values predicted from the regression with observed values. None of the data include jacks.



## Harvest Rate

We estimated that anglers harvested an average of 23% of the large spring chinook salmon that returned annually to the Rogue River in 1961-94. Annual estimates of harvest rates ranged between 13% in 1984 and 36% in 1993 (Appendix Table F-49). These estimates of harvest rate do not include small chinook salmon that anglers were not required to enter on salmon-steelhead cards (<51 cm in 1961-76 and <60 cm in 1977-1994).

**Downstream of Gold Ray Dam:** We estimated that harvest rates of spring chinook salmon large enough to be recorded on salmon-steelhead cards averaged 13% (SE = 0.8) and ranged between 4% and 26% annually in 1961-94 (Appendix Table F-49). These estimates were pooled for wild and hatchery fish. Harvest rates specific to wild and hatchery fish of different ages could only be estimated for 1979-81.

We found that harvest rates of large spring chinook salmon did not change after the operation of Lost Creek Dam. Estimates of annual harvest rates averaged 27.2% in 1961-77 and averaged 29.2% in 1978-94. A t-test with arcsin transformed data indicated no significant difference in the means ( $P = 0.208$ ). Data used in the analysis are in Appendix Table F-49.

Estimates of harvest rates in 1979-81 indicated that older spring chinook salmon were harvested at greater rates than younger spring chinook salmon. Among wild and hatchery fish, age 2 and age 3 fish were harvested at lower rates than age 4-6 fish (Table 73). Harvest rates of age 2 fish averaged only 8% of the harvest rates of age 4-6 fish (Table 73). Harvest rates of age 3 fish averaged 44% of the harvest rates of age 4-6 fish (Table 73).

Table 73. Estimated harvest rates of age 2-6 spring chinook salmon caught downstream of Gold Ray Dam, 1979-81.

Year	Age 2	Age 3	Age 4	Age 5	Age 6	Age 4-6
<b>WILD</b>						
1979	0.000	0.055	0.135	0.124	0.000	0.131
1980	0.000	0.000	0.080	0.104	0.000	0.085
1981	0.038	0.083	0.086	0.131	0.220	0.121
MEAN	0.012	0.046	0.100	0.119	0.073	0.112
<b>HATCHERY</b>						
1980	0.000	0.105	0.143	0.155	0.000	0.144
1980	0.000	0.000	0.106	0.095	0.000	0.104
1981	0.000	0.089	0.101	0.141	0.397	0.133
MEAN	0.000	0.064	0.117	0.130	0.132	0.127

We used these differences in harvest rates to estimate the harvest rates of age 2 and age 3 fish in 1974-94 (Appendix Table F-50). These estimates were needed to estimate the number of spring chinook salmon that returned to freshwater at each age (see Abundance at River Entry, page 101) and to estimate the number of fish of each age in the ocean during spring (see Abundance in the Ocean, page 106).

Younger fish were probably harvested at lower rates because age 2 and age 3 fish migrated later than older adults (see Migration Timing, page 157) and so passed through the fishery when flow conditions were less conducive to harvest (see Harvest, page 192). It is also possible that anglers targeted on larger fish as compared to smaller fish. Differences in harvest rates of chinook salmon of different ages have been also been documented for other fisheries (Holtby et al. 1992).

Among spring chinook salmon of the same age, there was an indication that hatchery fish may have been harvested at a greater rate in the lower river fishery as compared to wild fish. Mean harvest rates of hatchery fish exceeded the mean harvest rates of wild fish for all age classes with the exception of age 2 jacks (Table 73). The potential for differences in the harvest rates of wild and hatchery fish likely increased in later years as wild fish produced after reservoir operation migrated later as compared to counterparts produced before reservoir operation (see Migration Timing, page 157). Wild spring chinook salmon harvested in the lower river during 1979-81 were a mixture of fish produced before and after reservoir operation.

**Upstream of Gold Ray Dam:** We estimated that harvest rates of spring chinook salmon large enough to be recorded on salmon-steelhead cards averaged 15.5% (SE = 0.94) and ranged between 9.8% and 28.6% annually in 1971-94 (Appendix Table F-49). These estimates are pooled for wild and hatchery fish. Harvest rates specific to wild and hatchery fish of different ages could only be estimated for 1980 and 1981.

Estimates of harvest rates in 1980-81 indicated that older spring chinook salmon were harvested at greater rates than younger spring chinook salmon. Among wild fish, age 2 fish were harvested at lower rates than age 4, age 5, and age 6 fish in 1980 and 1981 (Table 74). Age 3 fish were harvested at a lower rate than older fish in 1981 (Table 74). Among hatchery fish, age 2 and age 3 fish were harvested at lower rates than older fish in 1980 and 1981 (Table 74). Younger fish were probably harvested at lower rates because age 2 and age 3 fish enter the upper river later than older adults and are exposed to the fishery for a shorter period of time (see Migration Timing, page 157).

Among fish of the same age, wild fish tended to be harvested at greater rates than hatchery fish. In 1980 and 1981, harvest rates of wild fish exceeded those of hatchery fish for age 2, age 3, and age 4 spring chinook salmon (Table 74). Harvest rates of hatchery fish exceeded those of wild fish for age 5 fish in 1980 and age 6 fish in 1981 (Table 74). Wild fish may have been harvested at greater rates in 1980 and 1981 because most hatchery fish entered Cole M. Rivers Hatchery while the fishery remained open (ODFW, unpublished data), while wild fish continued to contribute to the harvest.

Differences in harvest rates of among wild and hatchery fish of the same age may have lessened after 1981 because the relative abundance of early-run

Table 74. Estimated harvest rates of age 2-6 spring chinook salmon caught upstream of Gold Ray Dam, 1980-81.

Year	Age 2	Age 3	Age 4	Age 5	Age 6	Age 4-6
<b>WILD</b>						
1980	0.125	0.191	0.212	0.186	0.245	0.206
1981	0.200	0.163	0.323	0.402	0.359	0.368
MEAN	0.161	0.177	0.268	0.294	0.302	0.287
<b>HATCHERY</b>						
1980	0.087	0.085	0.135	0.221	0.000	0.147
1981	0.092	0.141	0.266	0.323	0.436	0.294
MEAN	0.090	0.113	0.200	0.272	0.218	0.230

fish decreased within the wild population while the relative abundance of hatchery fish increased (see Run Composition, page 154 and Migration Timing, page 157). In contrast, younger spring chinook salmon probably continue to be harvested at lower rates in the upper river fishery because they pass Gold Ray Dam later as compared to older cohorts.

We used the differences in harvest rates to estimate the harvest rates of age 2 and age 3 fish in 1974-94 (Appendix Table F-51). These estimates were needed to estimate the number of spring chinook salmon that survived to spawn (see Abundance at River Entry, page 101).

### Fishery Selectivity

We found that the fishery in each area of the river was age-selective, and that the lower river fishery was more age-selective as compared to the upper river fishery. We also found that selectivity ratios of wild and hatchery fish did not differ consistently in either of the fisheries.

Results suggested that age 5 and age 6 fish contributed to the lower river fishery at extremely high rates during 1979-81, while age 2 fish made almost no contribution to the fishery (Table 75). Trends in age selectivity were similar among wild and hatchery fish, and selectivity ratios did not seem to vary greatly among fish of the same age (Table 75).

With the exception of age 5 fish, selectivity ratios estimated for the upper river fishery in 1980-81 were also not greatly disparate for wild and hatchery fish of the same age (Table 76). Similar to the lower river fishery, the upper river fishery was selective for age 5 and age 6 fish (Table 76). However, the upper river fishery was less selective against younger fish as

Table 75. Selectivity ratios estimated for wild and hatchery spring chinook salmon harvested near Gold Beach, 1979-81.

Year	Wild			Hatchery		
	Proportion in Harvest	Return	Selectivity ratio <sup>a</sup>	Proportion in Harvest	Return	Selectivity ratio <sup>a</sup>
<b>AGE 2</b>						
1979	0.000	0.028	0.00	0.000	0.034	0.00
1980	0.000	0.229	0.00	0.000	0.207	0.00
1981	0.022	0.063	0.36	0.000	0.055	0.00
Mean	0.007	0.106	0.12	0.000	0.098	0.00
<b>AGE 3</b>						
1979	0.106	0.218	0.49	0.177	0.217	0.81
1980	0.000	0.038	0.00	0.000	0.073	0.00
1981	0.205	0.257	0.80	0.368	0.439	0.84
Mean	0.104	0.171	0.43	0.182	0.243	0.55
<b>AGE 4</b>						
1979	0.638	0.521	1.22	0.764	0.700	1.09
1980	0.714	0.560	1.28	0.869	0.610	1.42
1981	0.205	0.264	0.78	0.263	0.288	0.91
Mean	0.519	0.448	1.09	0.632	0.533	1.14
<b>AGE 5</b>						
1979	0.255	0.230	1.11	0.059	0.050	1.19
1980	0.286	0.169	1.70	0.131	0.103	1.26
1981	0.455	0.367	1.24	0.263	0.198	1.33
Mean	0.332	0.255	1.35	0.151	0.117	1.26
<b>AGE 6</b>						
1979	0.000	0.003	0.00	0.000	0.000	--
1980	0.000	0.005	0.00	0.000	0.007	0.00
1981	0.114	0.049	2.32	0.105	0.020	5.34
Mean	0.038	0.019	0.78	0.035	0.009	2.67

<sup>a</sup> Proportion in the angler harvest/proportion in the freshwater return.

Table 76. Selectivity ratios estimated for wild and hatchery spring chinook salmon harvested upstream of Gold Ray Dam, 1980-81.

Year	Wild			Hatchery		
	Proportion in Harvest	Return	Selectivity ratio <sup>a</sup>	Proportion in Harvest	Return	Selectivity ratio <sup>a</sup>
<b>AGE 2</b>						
1980	0.161	0.243	0.66	0.144	0.220	0.65
1981	0.044	0.069	0.63	0.028	0.060	0.48
Mean	0.102	0.156	0.65	0.086	0.140	0.56
<b>AGE 3</b>						
1980	0.038	0.039	0.99	0.055	0.074	0.74
1981	0.145	0.267	0.54	0.306	0.452	0.68
Mean	0.092	0.153	0.76	0.180	0.263	0.71
<b>AGE 4</b>						
1980	0.618	0.548	1.13	0.616	0.598	1.03
1981	0.274	0.258	1.06	0.362	0.278	1.30
Mean	0.446	0.403	1.09	0.489	0.438	1.16
<b>AGE 5</b>						
1980	0.175	0.165	1.06	0.186	0.101	1.83
1981	0.480	0.359	1.34	0.263	0.191	1.38
Mean	0.328	0.262	1.20	0.225	0.146	1.60
<b>AGE 6</b>						
1980	0.008	0.005	1.50	0.000	0.007	0.00
1981	0.057	0.048	1.20	0.040	0.019	2.12
Mean	0.033	0.026	1.35	0.020	0.013	1.06

<sup>a</sup> Proportion in the angler harvest/proportion in the freshwater return.

compared to the lower river fishery. For example, the mean selectivity rates for age 2 fish ranged between 0 and 0.12 in the lower river fishery and ranged between 0.56 and 0.65 in the upper river fishery.

In addition, we estimated selectivity ratios for marked and unmarked spring chinook salmon kept by anglers who fished the upper river in 1987-90. These data also indicated that the fishery was highly age-selective, with

older spring chinook salmon being harvested at greater rates as compared to younger fish. The proportions of age 2 and age 3 fish in the angler harvest were almost always less than the proportions of age 2 and age 3 fish among spring chinook salmon that passed Gold Ray Dam (Table 77). In contrast, the proportions of age 4 and age 5 fish in the angler harvest were almost always greater than the proportions of age 2 and age 3 fish among spring chinook salmon that passed Gold Ray Dam (Table 77).

As compared to data collected in 1980-81, results from sampling in 1987-90 suggested that selectivity ratios for age 2 and age 3 fish in the upper river fishery were much lower, especially for age 2 fish, than selectivity ratios estimated for 1980-81. A number of possibilities may account for the differences but we suspect that the estimates for 1987-90 are more accurate because the survey clerk measured every fish that was randomly seen. However, we were unable to determine if selectivity ratios differed between wild and hatchery fish because scale samples were not collected.

### Simulation Model

We developed a simulation model for chinook salmon produced in the Rogue River Basin upstream of Gold Ray Dam. Assuming that an appropriate model can be developed, then three primary benefits should accrue. First, simulations should result in more effective recommendations for reservoir management through a synthesis of the multitude of project findings. Second, simulations should identify the primary factors that affect the production and harvest of chinook salmon in the Rogue River. Finally, simulations should identify areas where additional work may improve understanding of population dynamics of chinook salmon produced in the Rogue River.

### Model Structure

Model structure reflects the basic life history of wild spring chinook salmon, wild fall chinook salmon, and spring chinook salmon of hatchery origin during periods of freshwater and ocean residence. The model simulates population and harvest parameters for one brood year based on selected values of input variables (Figures 67 and 68). We chose to simulate only a single brood year because we were unable to identify factors that could account for the wide variations in ocean survival rates. Input variables are listed and described in Table 78.

Regression equations compose the primary components of the model. All regressions incorporated in the model were previously presented in this report (Table 79). We that assumed these regressions were independent of each other for the purposes of simulation analyses. In actuality, regressions were not independent of each other because many were developed with the same sets of independent variables that included the same sources of measurement errors.

For wild fish, the model begins with predictions of the number of subyearling chinook salmon that migrate downstream past Savage Rapids Dam. Predictions of migrant abundance are estimated from input values selected for (1) peak flow during the period eggs and alevins incubate in the gravel, (2) water temperature during the period eggs, and most of the alevins,

Table 77. Selectivity ratios estimated for marked and unmarked spring chinook salmon harvested upstream of Gold Ray Dam, 1987-90. Unmarked hatchery fish could not be segregated from wild fish.

Year	Marked			Unmarked		
	Proportion in Harvest	Return	Selectivity ratio	Proportion in Harvest	Return	Selectivity ratio
<b>AGE 2</b>						
1987	0.014	0.053	0.26	0.038	0.134	0.28
1988	0.000	0.044	0.00	0.013	0.069	0.18
1989	0.000	0.021	0.00	0.008	0.040	0.20
1990	0.023	0.034	0.68	0.022	0.044	0.50
Mean	0.008	0.038	0.23	0.020	0.072	0.29
<b>AGE 3</b>						
1987	0.004	0.042	0.11	0.134	0.218	0.62
1988	0.194	0.274	0.71	0.139	0.270	0.52
1989	0.127	0.098	1.30	0.129	0.196	0.66
1990	0.109	0.140	0.78	0.095	0.106	0.90
Mean	0.108	0.138	0.72	0.124	0.198	0.67
<b>AGE 4</b>						
1987	0.946	0.883	1.07	0.737	0.591	1.25
1988	0.493	0.471	1.05	0.664	0.556	1.19
1989	0.723	0.796	0.91	0.752	0.689	1.09
1990	0.771	0.724	1.06	0.684	0.683	1.00
Mean	0.773	0.718	1.02	0.709	0.630	1.13
<b>AGE 5</b>						
1987	0.036	0.022	1.62	0.092	0.058	1.59
1988	0.313	0.211	1.48	0.185	0.104	1.77
1989	0.150	0.086	1.75	0.110	0.075	1.46
1990	0.086	0.114	0.75	0.190	0.161	1.18
Mean	0.146	0.108	1.40	0.144	0.100	1.50
<b>AGE 6</b>						
1987	0.000	0.000	--	0.000	0.000	--
1988	0.000	0.000	--	0.000	0.000	--
1989	0.000	0.000	--	0.000	0.000	--
1990	0.000	0.000	--	0.009	0.006	1.42
Mean	0.000	0.000	--	0.000	0.000	--

<sup>a</sup> Estimated from fish measured by the survey clerk and from size at age data.

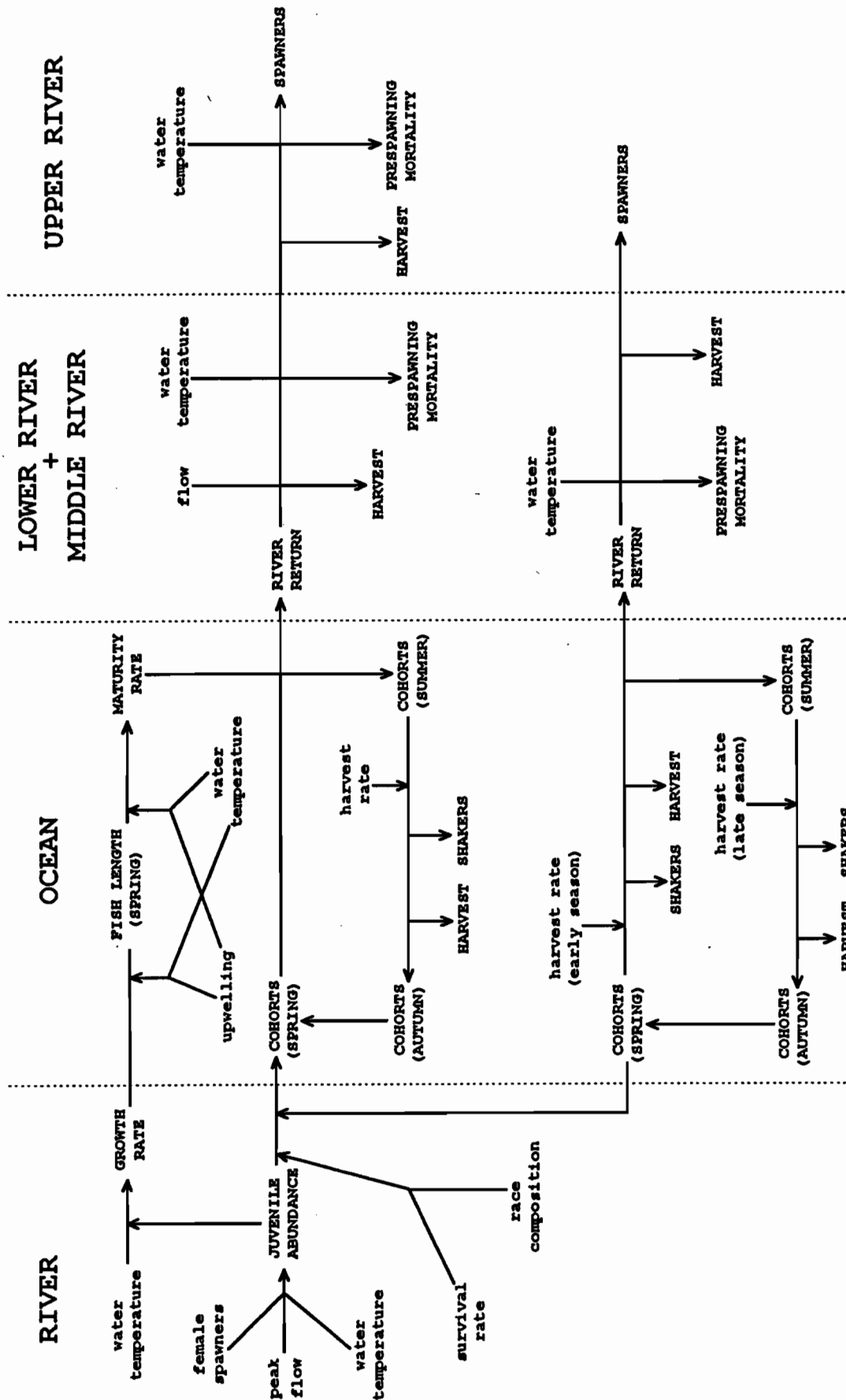

Figure 67. Schematic of the simulation model for wild chinook salmon produced in the Rogue River upstream of Gold Ray Dam. The upper half of the page portrays spring chinook salmon. The lower half of the page portrays fall chinook salmon. Input variables are in small type. Output variables are in large type.



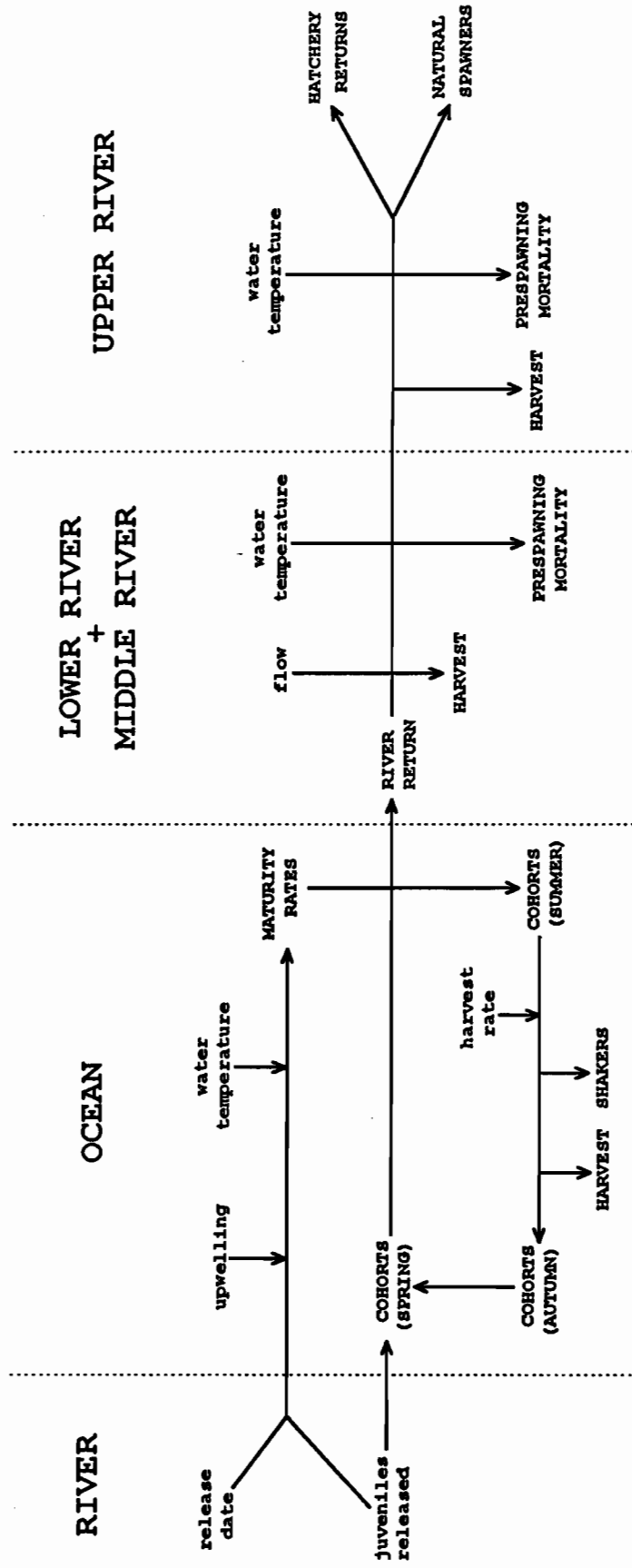

Figure 68. Schematic of the simulation model for spring chinook salmon released at Cole M. Rivers Hatchery. Input variables are in small type. Output variables are in large type.

Table 78. Input variables for the simulation model of chinook salmon produced in the upper portion of the Rogue River. Spring chinook salmon are abbreviated as CHS and fall chinook salmon are abbreviated as CHF.

Input Parameter	Mean	SD	Range	Values for simulations
<b>FRESHWATER FACTORS THAT AFFECT JUVENILE PRODUCTION AND SURVIVAL</b>				
Number of females that spawned	9,692	5,688	4,099 to 22,586	10,000
Peak flow (cfs) during embryo incubation	16,841	9,813	1,650 to 35,600	17,000
Water temperature (°C) during embryo incubation	8.1	0.60	6.6 to 8.8	8.0
Water temperature (°C) during fry residence	13.0	0.79	12.0 to 14.6	13.0
Recruit composition (proportion fall race)	0.26 <sup>a</sup>	0.167 <sup>a</sup>	0.12 to 0.76	0.26 <sup>b</sup>
Number (millions) of smolts released from hatchery	1.0	0.5	<0.1 to 1.7	1.6 <sup>b</sup>
Release date (day-of-year) from hatchery	302	40	258 to 368	259 <sup>b</sup>
Weight (grams) of hatchery smolts	61	11.7	44 to 83	50 <sup>b</sup>
Survival rate (proportion) to age 2	0.08 <sup>a</sup>	0.051 <sup>a</sup>	0.02 to 0.22	0.08
<b>OCEAN FACTORS THAT AFFECT SURVIVAL AND MATURITY</b>				
Harvest rate (proportion) of age 3 fish	0.28	0.183	0.03 to 0.65	0.25
Harvest rate (proportion) of age 4 fish	0.45	0.247	0.04 to 0.80	0.45
Summer upwelling (Bakun units)	344	95	181 to 535	344
Autumn upwelling (Bakun units)	14	51	-90 to 105	14
Winter upwelling (Bakun units)	-183	147	-566 to -5	-183
Spring upwelling (Bakun units)	106	79	-65 to 263	106
Summer water temperature (°C)	12.4	0.67	11.5 to 13.7	12.4
Autumn water temperature (°C)	11.7	0.63	10.7 to 13.4	11.7
Winter water temperature (°C)	10.1	0.77	8.7 to 11.6	10.1
Spring water temperature (°C)	11.0	0.74	9.8 to 12.8	11.0
<b>FRESHWATER FACTORS THAT AFFECT ADULT SURVIVAL AND HARVEST</b>				
Flow (cfs) in canyon during lower river fishery	6,089	2,764	1,818 to 12,665	6,100
Water temperature (°C) in canyon during CHS migration	17.2	1.34	15.2 to 19.2	17.2
Water temperature (°C) in upper river during CHS migration	16.9	0.99	15.3 to 18.8	16.9
Water temperature (°C) in canyon during CHF migration	20.0	0.90	18.8 to 22.1	20.0

<sup>a</sup> Estimated from a non-normal distribution.

<sup>b</sup> Value was chosen to reflect current conditions.

Table 79. Description of relationships incorporated in the simulation model for chinook salmon produced in the upper portion of the Rogue River.

---

#### **WILD CHINOOK SALMON**

Number of subyearling migrants: regression in Appendix Table D-9  
Freshwater growth rate: regression in Appendix Table D-15  
Fish length at annulus one: regression in Appendix Table E-47  
Fish length at annulus two: regression in Appendix Table E-51  
Fish length at annulus three: regression in Appendix Table E-55  
Maturity rate at age 2: regression in Table 48  
Maturity rate at age 3: regression in Table 48  
Maturity rate at age 4: regression in Table 48  
Maturity rate at age 5: regression in Table 48

#### **SPRING CHINOOK SALMON OF HATCHERY ORIGIN**

Maturity rate at age 2: regression in Table 43  
Maturity rate at age 3: regression in Table 43  
Maturity rate at age 4: regression in Table 43

#### **SPRING CHINOOK SALMON DOWNSTREAM OF GOLD RAY DAM**

Harvest of age 4-6 fish: regression in Appendix Table F-35  
Prespawning mortality: regression in Appendix Table E-90

#### **SPRING CHINOOK SALMON UPSTREAM OF GOLD RAY DAM**

Harvest of age 4-6 fish: regression in Appendix Table F-38  
Prespawning mortality: regressions in Appendix Tables E-98 AND E-99

#### **FALL CHINOOK SALMON DOWNSTREAM OF GOLD RAY DAM**

Prespawning mortality: regression in Appendix Table C-22 of ODFW (1992)

---

incubate in the gravel, and (3) the numbers of female chinook salmon that spawn upstream of Gold Ray Dam. Growth rates of wild juveniles in freshwater are predicted from an input value for water temperature during freshwater residence and the prediction of the number of wild juveniles that migrate downstream (Figure 67).

Numbers of wild smolts that enter the ocean are segregated into spring and fall races based on a racial composition value selected as an input variable. From this point on, the model handles spring chinook salmon and fall chinook salmon separately. Numbers of wild fish that survive until spring of the year after ocean entry are predicted from the prediction of the number of wild juveniles that migrate downstream and from an input value selected for the survival rate of hatchery fish released on 15 September that is multiplied by 0.43 to predict the survival rate of wild fish (Figure 67).

**Wild Spring Chinook Salmon:** Each year, some of the fish mature and return to freshwater prior to the opening of ocean fisheries for chinook

salmon. Maturity rates at ages 2-5 are predicted from predictions of fish lengths at the time of annulus formation in spring and from input values selected for indexes of ocean physical factors. Fish length at formation of the first annulus is predicted from input values for indexes of ocean physical factors and the prediction of freshwater growth rate. Lengths at other annuli are predicted from the fish length when the preceding annulus formed and from input values for indexes of ocean physical factors (Figure 67).

Immature spring chinook salmon that remain in the ocean are exposed to consumptive fisheries. Fish are harvested at ages 3-5 and the harvest rates of age 3 and age 4 fish are selected as input variables (Figure 67). The harvest rate of age 5 fish is assumed to equal the harvest rate of age 4 fish. Some age 2 and age 3 fish are killed as a result non-harvest fishing mortality. These fish are too small to be legally retained and are known as shakers. Fish that are not killed as a result of the ocean fisheries are assumed to have a overwinter survival rate of 0.5 between age 2 and age 3 and are assumed to have an overwinter survival rate of 0.8 between successively older ages. All age 6 fish are assumed to mature and return to freshwater.

Spring chinook salmon are susceptible to angler harvest and prespawning mortality in the Rogue River. Angler harvest of age 4-6 fish in the lower river and in the middle river is predicted from an input value for flow during the fishery and the predicted number of fish entering the river (Figure 67). Age-specific estimates of harvest for age 4-6 fish are then predicted from mean selectivity ratios estimated from fish harvested in the lower river during 1979-81. Harvest of age 2 and age 3 fish are then predicted from harvest rates and the predicted number of fish entering the river. Harvest rates of age 3 fish are predicted as 0.44 of the predicted harvest rate of age 4-6 fish and harvest rates of age 2 fish are predicted as 0.08 of the predicted harvest rate of age 4-6 fish.

Total harvest of age 4-6 fish in the upper river is predicted from the predicted number of wild fish passing Gold Ray Dam and an average harvest rate of 0.215. Age-specific estimates of harvest for age 4-6 fish are then predicted from selectivity ratios estimated from sampling the upper river fishery in 1987-90. We assumed selectivity ratios of: 0.40 for age 2 fish, 0.70 for age 3 fish, 1.20 for age 4 fish, and 1.60 for age 5-6 fish.

Rates of prespawning mortality in the area downstream of Gold Ray Dam, and in the upper river, are predicted from input values for water temperature in each section of the river (Figure 67). All fish that escape harvest and prespawning mortality are assumed to spawn naturally. The model assumes that females compose 53% of the age 4-6 spawners, but none of the age 2-3 spawners.

**Wild Fall Chinook Salmon:** Fall chinook salmon of Rogue River origin are susceptible to the ocean fisheries before any mature during summer. The model assumes that cohorts that fail to mature are impacted by the ocean fisheries to the same extent as immature spring chinook salmon (Figure 67). The model assumes that fish destined to mature in a given year are impacted by the ocean fisheries at one-half of the impact rates on non-maturing cohorts. Maturity rates of fall chinook salmon in the model are assumed to be equal to the maturity rates estimated for the 1983-89 brood years.

Like spring chinook salmon, fall chinook salmon in the Rogue River are susceptible to prespawning mortality and angler harvest. The rate of prespawning mortality is predicted from an input value for water temperature at Agness (Figure 67). Harvest rate in the lower river and in the middle river is assumed to be constant at 0.10 for all age classes. Adult fish that escape harvest and prespawning mortality are assumed to spawn naturally. The model assumes that females account for 50% of the age 3-6 spawners (ODFW 1992).

**Spring Chinook Salmon of Hatchery Origin:** There are some differences in how the model simulates the production and harvest of hatchery fish as compared to the production and harvest of wild fish (Figures 67 and 68). The number of smolts released from the hatchery, and the survival rate of those fish in the ocean through spring of the succeeding year, are selected as input variables. Although we were able to develop a multiple regression that accounted variations in smolt to age 2 survival rates (see **Spring Chinook Salmon of Hatchery Origin:**, page 112), we chose not to incorporate the regression in the model because trial simulations indicated that the regression effectively simulated survival rates only when hatchery fish survived at low rates.

Maturity rates of hatchery fish at ages 2-4 are predicted from an input value for the date that smolts are released from the hatchery and from input values selected for indexes of ocean physical factors (Figure 68). The maturity rate of age 5 fish is assumed to be constant at 0.95.

Estimation of ocean harvest, freshwater returns, prespawning mortality, river harvest, and spawning escapement are simulated exactly as for wild spring chinook salmon, except that we assumed that 5% of the hatchery fish spawned naturally rather than entering Cole M. Rivers Hatchery.

## **Model Evaluation**

Simulations are of greatest utility when model performance can be rigorously tested under controlled conditions. As we lacked such an opportunity, we instead evaluated the resolution, realism, and precision of the model. Resolution relates to the inclusion of key components of the ecosystem. The greater the number of components, the greater the resolution of a model. Realism relates to the propriety of the equations used in a model. When components appropriately identify causative relationships among biological parameters and physical factors, the resultant model exhibits a high degree of realism. Precision relates to the degree of uncertainty associated with model output. Models with lower precision have greater uncertainty associated with output predictions.

We believe that this model exhibits a relatively high degree of resolution with four major exceptions. First, the model assumes constant survival rates of chinook salmon between juvenile migrant and age 2 life history stages. Second, the model assumes that chinook salmon resident in the ocean survive at constant rates during late autumn through early spring. Third, the model assumes that fall chinook salmon account for a constant proportion of the wild chinook salmon produced in the upper river. Finally, this type of model fails to account for the affects of other types of aquatic organisms on the production and harvest of chinook salmon.

Identification of factors that affect rates of natural mortality of chinook salmon in the ocean is quite difficult. For example, intensive work continues with coho salmon in the Oregon Production Index Area to attempt to answer that question. Estimation of mortality rates is even more complex for chinook salmon that mature at five ages rather than two ages as for coho salmon. We concluded that further attempts to improve resolution of the model would be a lengthy and expensive task. We recommend no additional work to improve model resolution unless findings from other research can be incorporated into the model with minimal effort.

We believe the portion of the model that encompasses the freshwater environment has a relatively high degree of realism. In many cases, our results were similar to findings reported in the published literature. The primary exception was our finding that indicated juvenile production increased ad infinitum with increased spawning escapement. This conclusion might be appropriate for the range of data that we gathered, but is probably not appropriate for greater levels of spawning escapement. At some level, compensatory factors must act to limit the number of wild juvenile chinook salmon produced in the Rogue River.

In contrast, we believe that the portion of the model that encompasses the ocean environment has a very low degree of realism. We indexed the physical conditions of the ocean with measurements of upwelling and water temperature at two sites along the coast. These measurements may, or may not, characterize the physical parameters in areas of the ocean inhabited by chinook salmon of Rogue River origin. Even if the indexes were appropriate, variations in upwelling and water temperature would have had indirect, rather than direct, effects on chinook salmon. Factors that directly influence the survival rate of chinook salmon in the ocean remain relatively unknown, or at least their effects cannot be quantified at this time.

A simulation with mean values for input variables indicated that the model has a relatively high degree of precision. Coefficients of variation associated with most of the key output parameters were less than 20% (Table 80). Variability among output responses were highest for predictions of prespawning mortality (Table 80). Variability among output responses were least for predictions of ocean harvest, freshwater escapement, freshwater harvest, and spawning escapement (Table 80).

Predicted outputs from model simulation exhibit a high degree of precision because the simulations were run under the assumption of constant rates of survival in the ocean. Consequently, the precision of the outputs are primarily affected by environmental conditions in freshwater. As the primary purpose of the project was to develop optimal strategies for reservoir releases, the precision appears to be sufficient for that particular purpose.

### **Sensitivity Analyses**

Our findings suggested that the production and harvest of chinook salmon produced in the upper portion of the Rogue River was most sensitive to variations in (1) the survival rate, and number, of smolts released from Cole M. Rivers Hatchery, (2) the intensity of peak flow during the period that eggs and alevins incubated in the gravel, (3) the number of females that spawned

Table 80. Variability estimates of model outputs for a simulation with average values for input parameters (see Table 78).

Output parameter	Mean prediction	CV <sup>a</sup>	95% confidence boundary	
			Lower	Upper
<b>WILD SPRING CHINOOK SALMON</b>				
Ocean harvest (n)	10,405	10	8,414	12,536
Freshwater return (n)	16,143	10	13,204	19,429
Freshwater harvest (n)	4,165	11	3,224	5,064
Freshwater harvest rate (p)	0.26	7	0.22	0.30
Prespawning mortality (n)	681	22	419	992
Prespawning mortality rate (p)	0.04	12	0.03	0.05
Spawning escapement (n)	11,297	10	9,241	13,694
Female spawners (n)	3,966	11	3,093	4,788
<b>SPRING CHINOOK SALMON OF HATCHERY ORIGIN</b>				
Ocean harvest (n)	18,196	6	16,219	19,983
Freshwater return (n)	34,789	5	32,100	38,257
Freshwater harvest (n)	6,351	6	5,660	7,160
Freshwater harvest rate (p)	0.18	6	0.16	0.20
Prespawning mortality (n)	2,621	20	1,827	3,825
Prespawning mortality rate (p)	0.08	18	0.05	0.11
Hatchery return (n)	24,527	6	22,157	27,632
Proportion among spawners <sup>b</sup> (p)	0.07	10	0.06	0.09
<b>ALL CHINOOK SALMON</b>				
Ocean harvest (n)	32,360	5	29,273	35,556
Freshwater return (n)	57,343	5	52,438	62,496
Freshwater harvest (n)	11,056	7	9,693	12,573
Freshwater harvest rate (p)	0.19	6	0.17	0.22
Prespawning mortality (n)	4,312	17	3,092	5,718
Prespawning mortality rate (p)	0.08	14	0.06	0.10
Spawning escapement (n)	17,448	8	14,868	20,112
Female spawners (n)	6,362	8	5,320	7,308
Race composition of spawners <sup>c</sup> (p)	0.30	10	0.26	0.34

<sup>a</sup> Coefficient of variation.

<sup>b</sup> Among spring chinook salmon spawning naturally.

<sup>c</sup> Proportion of wild fish estimated to be fall chinook salmon.

naturally, and (4) the harvest rate of age 3 fish in the ocean (Appendix Tables G-1 through G-3). Predictions of harvest and production were less affected by variations in other input variables.

In contrast, sensitivity analyses suggested that the number of chinook salmon that died prior to spawning was most sensitive to variations in water temperature during the late spring and summer when adult fish were present in

the river (Appendix Table G-4). Predictions of prespawning mortality varied to lesser degrees as a result of variations in other input variables to the model.

Spawning escapement appeared to be most sensitive to changes in (1) the survival rate of smolts released from Cole M. Rivers Hatchery, (2) the intensity of peak flow, and water temperature, during the period that eggs and alevins incubated in the gravel, (3) the number of females that spawned naturally, and (4) water temperature during late summer when adult fall chinook salmon are susceptible to prespawning mortality (Appendix Table G-5). Predictions of harvest and production were less affected by variations in other input variables.

### Evaluation of Reservoir Release Strategies

We believe that the simulation model for chinook salmon can be used to evaluate alternative strategies for reservoir management and can also be used to determine how to optimize the release of cold water stored in the hypolimnion of the reservoir. While the sensitivity analyses indicated that release strategies that reduce water temperature of the river are beneficial for almost the entire year, there is only a limited supply of hypolimnetic storage available for that purpose.

Water temperature of the Rogue River is affected by the volume of flow, location on the river, air temperature, and water temperature at release from the reservoir (USACE 1991). Flow can vary greatly among years depending on the water yield from the basin. Hamlin-Tillman and Haake (1990) simulated water temperature in the Rogue River for a low flow year (1981), an average flow year (1986), and a high flow year (1984). Similar simulations are needed under varied reservoir management strategies. At a minimum, three management strategies should be simulated: (1) use of hypolimnetic storage during late spring and summer to minimize prespawning mortality among adult chinook salmon, (2) conservation of hypolimnetic storage for release in autumn to minimize the accelerated development of chinook salmon embryos, and (3) release of hypolimnetic storage partially during summer and partially during autumn.

There may also be a need to simulate water temperature of the Rogue River on an annual basis. Goals for fishery management can vary among years based on needs to protect fishes listed under the Endangered Species Act, expected returns of adult salmonids, management of ocean fisheries for chinook salmon, management of recreational fisheries in the Rogue River, and estimates of water yield from the basin.

At the present time, protection and restoration of wild spring chinook is the highest priority for ODFW. As reservoir releases impact wild spring chinook salmon more than other races of anadromous fish in the Rogue River, we developed some interim recommendations for release temperatures from Lost Creek Dam (Table 81). Our interim recommendations should be evaluated upon completion of additional simulations of water temperature by the USACE. The simulation model developed for chinook salmon can aid in such an evaluation, provided that proposed water temperature and flow regimes fall within the range of values used to help build the fisheries model.



Table 81. Provisional recommendations for the temperature (°F) of water to be released from Lost Creek Dam as compared to average water temperature recorded at a nearby site in 1970-76. Recommendations are provisional as additional water temperature simulations are needed to identify optimal releases in years of varied water yield and in years of differing fisheries management objectives.

Period	Recommended	1970-76	Period	Recommended	1970-76
April	01-07	45.0	October	01-07	45.0
	08-14	46.0		08-14	43.0
	15-21	47.0		15-21	41.0
	22-30	48.0		22-31	40.0
May	01-07	49.0	November	01-07	38.0 <sup>a</sup>
	07-14	50.0		08-14	38.0 <sup>a</sup>
	15-21	51.0		15-21	38.0 <sup>a</sup>
	22-31	51.0		22-30	38.0 <sup>a</sup>
June	01-07	51.0	December	01-07	38.0 <sup>a</sup>
	08-14	51.0		08-14	38.0 <sup>a</sup>
	15-21	52.0		15-21	38.0 <sup>a</sup>
	22-30	52.0		22-31	38.0 <sup>a</sup>
July	01-07	53.0	January	01-07	38.0 <sup>a</sup>
	08-14	53.0		08-14	38.0 <sup>a</sup>
	15-21	54.0		15-21	38.0 <sup>a</sup>
	22-31	54.0		22-31	38.0 <sup>a</sup>
August	01-07	55.0	February	01-07	38.0 <sup>a</sup>
	08-14	55.0		08-14	38.0 <sup>a</sup>
	15-21	55.0		15-21	39.0 <sup>a</sup>
	22-31	55.0		22-28	40.0
September	01-07	55.0	March	01-07	41.0
	08-14	53.0		08-14	42.0
	15-21	50.0		15-21	43.0
	22-30	47.0		22-31	44.0

<sup>a</sup> Recommended temperature will not likely be attained because the water temperature in the reservoir remains warmer than natural water temperature. The intent of the recommendation is to release the coldest water possible during these periods.

### IMPLICATIONS OF PROJECT FINDINGS

We concluded that the operation of Lost Creek Dam was associated with a decrease in the production of, and a change in the life history of, wild spring chinook salmon in the Rogue River. In contrast, we concluded that the operation of USACE dams in the Rogue River Basin was associated with an increase in the production of wild fall chinook salmon (ODFW 1992). Impacts

of USACE dams on the abundance and life history of wild steelhead and wild coho salmon were hardly evident, or could not be detected (ODFW 1990; ODFW 1991b; ODFW 1994); probably because those species tend to spawn in tributary streams unaffected by USACE dams.

Reservoir operations changed the physical parameters of the Rogue River (USACE 1991). Some of those changes were associated with changes in life history parameters of wild spring chinook salmon and a change in the composition of wild chinook salmon produced in the upper river. Among wild spring chinook salmon, the relative abundance of fish that migrated early decreased while the relative abundance of fish that migrated late increased. In addition, the relative abundance of wild fall chinook salmon also increased. These changes, coupled with other changes in life history parameters, decreased fishery yields of wild fish because of changes in migration timing and age at maturity.

The decrease in the production of wild spring chinook salmon is not unique to the Rogue River. Assessments completed by various parties concluded that populations of wild spring chinook salmon on the Pacific coast have decreased relative to coastal populations of wild fall chinook salmon (Myers et al. 1998). Maintenance of remaining populations of wild spring chinook salmon, including that of the Rogue River, would thus seem to be a high priority for resource managers.

Maintenance of a productive population of wild spring chinook salmon is particularly important in the Rogue River because of the associated social and economic benefits. After consideration of the findings reported in this document and findings reported for the other races of anadromous salmonids produced in the Rogue River (ODFW 1990; ODFW 1991b; ODFW 1992; ODFW 1994), we concluded that reservoir management strategies should be directed primarily at maintaining, and if possible enhancing, the population of wild spring chinook salmon. Recommendations for reservoir releases and reservoir management strategies (see Reservoir Management and Operation of Lost Creek Dam, page 7) were developed accordingly.

Enhancement of wild spring chinook salmon in the Rogue River has been a goal of ODFW and the USACE for more than 20 years. However, as we describe in this report, experimental releases of reservoir storage have yet to restore the life history or abundance of wild spring chinook salmon. Consequently, we believe it is unlikely that implementation of our recommendations for reservoir releases will restore the abundance and life history parameters of wild spring chinook salmon to preimpoundment conditions. Consequently, fishery managers should consider restoration measures other than reservoir releases.

By one measure, hatchery fish have compensated for the loss of wild spring chinook salmon. We found that the decreased production of spawning habitat was successfully mitigated by the production of hatchery fish based on a mitigation goal of 13,000 adult hatchery fish passing Gold Ray Dam. The large returns of hatchery fish can be attributable to (1) improved spawning, rearing, and release practices at Cole M. Rivers Hatchery, (2) younger ages at maturity among hatchery fish, and (3) decreased harvest rates in the ocean fisheries. Success of the hatchery program, coupled with a decrease in the production of wild fish, resulted in runs of spring chinook salmon that have averaged about 75% hatchery fish since 1990 (ODFW, unpublished data).

However, the increased abundance of hatchery fish and the decreased abundance of wild fish poses challenges for fishery managers that were not foreseen when the USACE project was authorized by the United States Congress in 1962. Two primary issues are that spring chinook salmon of Rogue River origin (1) do not meet requirements of the Wild Fish Policy adopted by the Oregon Fish and Wildlife Commission in 1992 and (2) generate concern among recreational and commercial fishers because of the large numbers of unneeded hatchery fish that return to Cole M. Rivers Hatchery. In addition, resource agencies are shifting management priorities from individual species of animals, that have commercial and recreational importance, towards a more generalized priority of ecosystem management.

Many concerns have been raised about the effects of hatchery fish on sympatric or proximal populations of wild fish. Potential problems associated with the production of hatchery fish include: alteration of gene pools of wild fish, (Johnsson and Abrahams 1991; Hindar et al. 1991; Waples 1991); predation on wild fish (Evenson et al. 1981), competition with wild fish (Swain and Riddell 1990; Mesa 1991; Berejikian 1995), transmission of disease (Mitchum et al. 1979); and reductions in stock productivity (Reisenbichler et al. 1977; Chilcote et al. 1986; Leider et al. 1990).

We estimated that about 5% of the spring chinook salmon of hatchery origin spawned naturally, with most of the strays spawning in the vicinity of Cole M. Rivers Hatchery. Assuming that (1) hatchery fish will continue to compose about 75% of the adult spring chinook that pass Gold Ray Dam, (2) harvest rates upstream of Gold Ray Dam will be about 10% on hatchery fish and 20% on wild fish, (3) negligible prespawning mortality, and (4) that 5% of the hatchery fish spawn naturally, we estimate that hatchery fish will account for 13% of the naturally spawning spring chinook salmon.

With hatchery fish among the natural spawners, one would suspect that the life history parameters of wild fish would become more similar to those of wild fish (Unwin and Glova 1997). Instead, we found that the life history parameters of wild fish changed coincidentally with the construction and operation of Lost Creek Dam.

We believe that the spring chinook salmon program at Cole M. Rivers Hatchery is important for numerous reasons that include: (1) production mitigates for spawning habitat blocked by Lost Creek Dam, (2) some of the important life history characteristics of the hatchery fish are more similar to that portion of the endemic population of spring chinook salmon that spawned upstream of Lost Creek Dam, (3) the broodstock was developed from wild fish that entered the hatchery when upstream spawning areas were blocked by reservoir construction in the early 1970s, (4) no genetic material from stocks outside of the Rogue River Basin has been incorporated into the broodstock, and (5) spawning practices have been managed in an attempt to maintain genetic diversity and to minimize potential genetic drift.

However, we also found that wild and hatchery fish differed in multiple life history attributes even though the hatchery stock was developed from endemic fish with no intentional infusion of genetic material from other chinook stocks and with diversified selection of spawners. Changes in the life history parameters of wild fish that resulted from reservoir construction and operation are at least partially responsible for the divergence of wild

and hatchery fish, but that does not necessarily mean that the two populations differ genetically. Even if there are significant genetic differences between the two populations, as compared to the current population of wild fish, the current stock of hatchery fish may better represent the genetic history of wild spring chinook produced in the upper river prior to reservoir operation. However, as even a short period of domestication may result in the development of genetically-based behavioral differences in wild and hatchery salmonids (Swain and Riddell 1990; Berejikian 1995; Berejikian et al. 1996), annual incorporation of genetic resources from wild fish seems advisable.

Our findings, coupled with current hatchery practices, indicate that current ODFW management practices are not in compliance with the Wild Fish Management Policy adopted by the Oregon Fish and Wildlife Commission in 1992. Current management strategies are not in compliance with the policy because hatchery fish probably compose more than 10% of the natural spawners, wild fish compose less than 30% of the hatchery broodstock, and wild-type phenotypes are not maintained in hatchery fish.

Fishery managers have five options by which to bring management strategies for spring chinook salmon into compliance with the Wild Fish Policy: (1) release no hatchery fish, (2) limit the number of hatchery fish to less than 50% of the natural spawners, (3) limit the number of hatchery fish to 10-50% of the natural spawners, (4) classify the production of hatchery fish as a special rehabilitation program with ongoing releases, and (5) an exemption from the policy. Implications associated with each of these options are discussed in the following text.

**Release no Hatchery Fish (Option 1):** Only wild spring chinook salmon would be produced under this option. No hatchery fish would be produced to mitigate for spawning habitat blocked by Lost Creek Dam.

**Limit Hatchery Fish to Less than 50% of the Natural Spawners (Option 2):** Adoption of this option requires that hatchery program has the following elements: (1) originate from the local wild population, (2) broodstock composed of at least 30% wild fish, (3) wild fish taken for broodstock account for less than 25% of the natural spawners, (4) no artificial genetic changes occur and unintentional genetic changes are avoided, (5) wild-type phenotypes are maintained in hatchery fish, and (6) annual monitoring and periodic evaluation.

Current and historic ODFW management activities meet the requirements of option 2 except that wild fish probably compose less than 10% of the broodstock (personal communication with Michael Evenson, ODFW, Central Point, Oregon on 12 October, 1998) and wild-type phenotypes are not maintained in hatchery fish. To ensure that at least 30% of the broodstock are hatchery fish, all juvenile hatchery fish will need to be marked with fin clips and broodstock will likely need to be collected at a second site in addition to Cole M. Rivers Hatchery. Gold Ray Dam may make a good secondary collection site because the migration timing of wild fish is well documented, at least for broods produced before reservoir construction.

Maintenance of wild-type phenotypes in hatchery fish is a more problematic question for fishery managers because of the uncertainty as to what are appropriate wild-type phenotypes for spring chinook salmon in the

Rogue River. One could contend that the life history parameters of hatchery fish should reflect those of the current population of wild fish because a primary purpose of the Wild Fish Policy is to minimize the potential impacts of hatchery fish on wild fish that are adapted to a specific environment. On the other hand, one could contend that the life history parameters of hatchery fish should reflect those of the historic population of wild fish because a primary purpose of the Wild Fish Policy is to prevent the irretrievable loss of genetic resources.

Broodstock selection practices at Cole M. Rivers Hatchery appear to have mostly maintained the life history parameters of the historic (preimpoundment) population of spring chinook salmon. If fishery managers decide that the appropriate life history parameters have been maintained in the current population of hatchery fish, and the composition of the broodstock changes to at least 30% wild fish, then the proportion of hatchery fish among the natural spawners could be increased. We estimate that about 13% of the natural spawners are hatchery fish when hatchery fish account for 75% of the spring chinook salmon that pass Gold Ray Dam.

Even without an increase in the relative abundance of wild fish, the proportion of hatchery fish among natural spawners could increase three-fold and still meet the requirements of the wild fish policy. Under this scenario, fishery managers have the option of developing methods to increase spawning escapement and fishery yields by decreasing the homing rate to Cole M. Rivers Hatchery. Natural spawning by hatchery fish can be increased through changes in sites of juvenile releases (Solazzi et al. 1991; Pascaul et al. 1995), time of juvenile releases (Unwin and Quinn 1993; Pascaul et al. 1995), size of juveniles at time of release (Richards and Cnera 1989) or through artificial imprinting of juveniles at sites other than Cole M. Rivers Hatchery (Cooper and Scholz 1976; Brannon et al. 1984).

However, while off-station releases of small hatchery fish probably would have minimal impact on wild juvenile steelhead (McMichael and Pearsons 1998) or wild juvenile coho salmon (ODFW 1991b), there is no guarantee that such releases will enhance the production of wild fish (Nickelson et al. 1986; Bryne et al. 1992; Winton and Hilborn 1994). In addition, releases should be carefully planned so that hatchery fish would have minimal impact on wild spring chinook salmon fry. Impacts could be reduced by (1) delaying the developmental rates of embryos so that hatchery fish would be smaller than wild fish at time of release (Chandler and Bjornn 1988) and by (2) releasing hatchery fry at sites downstream of Shady Cove.

Conversely, if fishery managers decide that the life history parameters of hatchery fish should mimic those of the present population of wild fish, then modification of broodstock selection practices will be needed. One primary change would be to shift broodstock composition to more late-migrating adults. This shift may change the genetic composition of the population because differences in genetic composition have been documented for chinook salmon within a single river basin (Beacham et al. 1996) and even among early-run and late-run chinook salmon in a single river (Adams et al. 1994).

The primary site of broodstock collection would need to be changed, probably to Gold Ray Dam. In addition, production of hatchery fish with wild-type life history parameters will probably decrease yields to the river

fisheries. Contribution rates to the fisheries are greatly affected by migration timing. Early migrants contribute to the fisheries at greater rates as compared to late migrants. Development of current wild-type life histories in the hatchery population will cause adult fish to migrate later as compared to their present time of migration.

**Limit Hatchery Fish to 10-50% of the Natural Spawners (Option 3):**

Adoption of this option requires that hatchery program has the same six elements as described for Option 2 except that, the further the deviation from the requirements of Option 2, the lower the proportion of hatchery fish allowed among natural spawners. In addition, if the hatchery population was not developed from the local wild population or more than 25% of the wild spawners are taken for hatchery broodstock, than hatchery fish could compose only 10% of the natural spawners.

As the spring chinook salmon program at Cole M. Rivers Hatchery currently meets the requirements listed in the last sentence of the previous paragraph, the allowable composition of natural spawners could range between 10% and 50%. The degree of deviation from the other requirements requires further evaluation because deviation criteria are not specifically stated in the Wild Fish Policy. If one assumes minimal deviation, then hatchery fish could compose 50% of the natural spawners. If one assumes maximal deviation, the hatchery fish could compose only 10% of the natural spawners. Under this later scenario, and assuming that hatchery fish account for 75% of the adults that pass Gold Ray Dam, releases at Cole M. Rivers Hatchery would need to be reduced from 1.6 million to 1.14 million juvenile spring chinook salmon in order to limit hatchery fish to 10% of the natural spawners.

**Classify Hatchery Fish as a Special Rehabilitation Program (Option 4):**

Adoption of this option would allow for hatchery fish to be used to restore a depressed wild population while also meeting the six requirements of Option 2. However, if ODFW determines that those requirements are likely to prevent restoration, then the following conditions apply: (1) deviations from the six requirements will not exceed one life-cycle without approval of the Oregon Fish and Wildlife Commission, (2) rationale for deviations from requirements are documented, and (3) rehabilitation standards and guidelines shall be documented.

Fishery managers may conclude that wild spring chinook salmon in the Rogue River are a depressed population, and that the release of hatchery fish may help restore the early-migrating portion of the run. ODFW would then attempt to develop methods that would encourage hatchery fish to spawn naturally in spawning areas historically used by early migrants. However, as the reduction in the early-migrating component of the wild population is associated with reservoir construction and operation, and because the reservoir will operate for the foreseeable future, it appears that hatchery fish would probably need to be continually released under this option. Continual releases without meeting the requirements outlined in Option 2 and Option 3 would require approval of the Oregon Fish and Wildlife Commission.

**Exempt Spring Chinook Salmon from the Wild Fish Policy (Option 5):**

The Oregon Fish and Wildlife Commission may decide that a population may be exempted from the Wild Fish Management Policy. Requirements associated with an exemption include (1) a request for an exemption, (2) the request be

considered at the meeting when the management plan for the relevant basin is considered or when ODFW presents a progress report on wild fish management, (3) completion of a written analysis of the request by ODFW, (4) a period of public review, and (5) the Commission concludes that social and economic considerations offset biological consequences, and shall not threaten a gene conservation group or cause a serious depletion of the species within Oregon.

Fishery managers may conclude that this option is appropriate if there are primary benefits associated with maintenance of the current program of spring chinook salmon at Cole M. Rivers Hatchery. Possible benefits of maintaining the current program may include: (1) cost and increased mortality associated with fin marking all of the 1.6 million juveniles released annually, (2) cost and increased mortality associated with trap and transport of adult fish from a secondary broodstock collection site, (3) no selective removal of early-run wild fish from a depressed population, and (4) maintenance of a population that may be most similar in life history and genetic composition to spring chinook salmon produced before the construction and operation of Lost Creek Dam.

Regardless of which Wild Fish Management Policy option is selected by fishery managers, or even whether spring chinook salmon are protected by the Endangered Species Act, management activities should interface with ecosystem processes in order to have a good chance of success. Ecosystems are dynamic entities, constantly changing with small and large variations in biotic and abiotic factors. Construction and operation of USACE reservoirs changed the Rogue River Basin ecosystem. Consequently, management plans and activities should recognize, that for the proximal future, it is not likely that the reservoirs will be managed so that water yields and water quality conform to preimpoundment conditions. Instead, it seems prudent to devise management plans and activities that attempt to produce optimal biological and social benefits within the constraints of current ecosystem functions.

#### ACKNOWLEDGEMENTS

This report presents 20 years of ODFW work with spring chinook salmon in the Rogue River. Numerous people within ODFW contributed to this effort. James Lichatowich initially designed the project and served as program leader. Steven Cramer and Alan McGie also served as program leaders. Steven Cramer, James Martin, Barry McPherson, Thomas Satterthwaite, and Allan Smith served as project leaders. This report was drafted by Thomas Satterthwaite who also was responsible for the analyses herein.

Almost 100 ODFW employees contributed as assistant project leaders and project assistants. Their efforts and constructive ideas greatly improved the project. The challenging task of scale interpretations were mostly completed by Gregory Apke, Mary Buckman, Patrick Frazier, Mark Schluchter, and Bruce Williams. Mary Buckman also developed the program to estimate error associated with output from the simulation model. Michael Evenson provided numerous data summaries and assisted with sampling, as did other ODFW staff stationed at Cole M. Rivers Hatchery.

The United States Geological Survey provided data on flow and water quality. The USACE provided estimates of the impacts of reservoir operations

on flow and water quality. The USACE funded the project and USACE reviewers provided suggestions that improved the project. Thomas Carlson, Jonathan Nestler, Clifford Pereira, and Rock Peters reviewed and improved an earlier draft of the report with their comments.

#### REFERENCES

- Adams, N.S., and five coauthors. 1994. Variation in mitochondrial DNA and allozymes discriminates early and late forms of chinook salmon (*Oncorhynchus tshawytscha*) in the Kenai and Kasilof rivers, Alaska. Canadian Journal of Fisheries and Aquatic Sciences 51 (Supplement 1): 172-181.
- Alderdice, D.F., and F.P.J. Velsen. 1978. Relation between temperature and incubation time for eggs of chinook salmon (*Oncorhynchus tshawytscha*). Journal of the Fisheries Research Board of Canada 35:69-75.
- Amandi, A., S.F. Hui, C.K. Arakawa, and J.S. Rohovec. 1982. Assessment of disease related mortality of adult salmonids in the Rogue River basin. Oregon State University, Department of Microbiology, Progress Report, Corvallis.
- Anderson, J.L., and J.E. Wilen. 1985. Estimating the population dynamics of coho salmon (*Oncorhynchus kisutch*) using pooled-time series and cross-sectional data. Canadian Journal of Fisheries and Aquatic Sciences 42:459-467.
- Baker, P.F., T.P. Speed, and F.K. Ligon. 1995. Estimating the influence of temperature on the survival of chinook salmon smolts (*Oncorhynchus tshawytscha*) migrating through the Sacramento - San Joaquin River Delta of California. Canadian Journal of Fisheries and Aquatic Sciences 52:855-863.
- Bams, R.A. 1969. Adaptations of sockeye salmon associated with incubation in stream gravels. Pages 71-87 in T.G. Northcote, editor. Symposium on salmon and trout in streams. University of British Columbia, H.R. MacMillan Lectures on Fisheries, Vancouver, Canada.
- Banks, J.L., L.G. Fowler, and J.W. Elliot. 1971. Effects of rearing temperature on growth, body form, and hematology of fall chinook fingerlings. Progressive Fish-Culturist 33:20-26.
- Barton, A.C. 1979. Factors influencing the life history of spring chinook salmon (*Oncorhynchus tshawytscha*) spawning in the Columbia River watershed from 1960-77. Doctoral dissertation, Oregon State University, Corvallis.
- Beacham, T.D., and C.B. Murray. 1990. Temperature, egg size, and development of embryos and alevins of five species of Pacific salmon: a comparative analysis. Transactions of the American Fisheries Society 119:927-945.
- Beacham, T.D., C.B. Murray, and R.E. Withler. 1989. Age, morphology, and biochemical variation of Yukon River chinook salmon. Transactions of the American Fisheries Society 118:46-63.



- Beacham, T.D., R.E. Withler, and T.A. Stevens. 1996. Stock identification of chinook salmon (*Oncorhynchus tshawytscha*) using minisatellite DNA variation. *Canadian Journal of Fisheries and Aquatic Sciences* 53:380-394.
- Beamesderfer, R.C. 1992. Reproduction and early life history of northern squawfish, *Ptychocheilus oregonis*, in Idaho's St. Joe River. *Environmental Biology of Fishes* 35:231-241.
- Beamesderfer, R.C., D.L. Ward, and A.A. Nigro. 1996. Evaluation of the biological basis for a predator control program on northern squawfish, *Ptychocheilus oregonis*, in the Columbia and Snake rivers. *Canadian Journal of Fisheries and Aquatic Sciences* 53:2898-2908.
- Beamish, R.J., C.M. Neville, B.L. Thomson, P.J. Harrison, and M. St. John. 1994. A relationship between Fraser River discharge and interannual production of Pacific salmon (*Oncorhynchus* spp.) and Pacific herring (*Clupeas pallasii*) in the Strait of Georgia. *Canadian Journal of Fisheries and Aquatic Sciences* 51:2843-2855.
- Becker, C.D., and M.P. Fujihara. 1978. The bacterial pathogen *Flexibacter columnaris* and its epizootiology among Columbia River fish. A review and synthesis. *American Fisheries Society, Monograph* 2.
- Beckman, B.R., D.A. Larsen, B. Lee-Pawlak, and W.W. Dickhoff. 1998. Relation of fish size and growth rate to migration of spring chinook salmon smolts. *North American Journal of Fisheries Management* 18:537-546.
- Berejikian, B. 1995. The effects of hatchery and wild ancestry and experience on the relative ability of steelhead trout fry (*Oncorhynchus mykiss*) to avoid a benthic predator. *Canadian Journal of Fisheries and Aquatic Sciences* 52:2476-2482.
- Berejikian, B.A., S.B. Mathews, and T.P. Quinn. 1996. Effects of hatchery and wild ancestry and rearing environments on the development of agonistic behavior in steelhead trout (*Oncorhynchus mykiss*) fry. *Canadian Journal of Fisheries and Aquatic Sciences* 53:2004-2014.
- Bilton, H.T. 1984. Returns of chinook salmon in relation to juvenile size at release. *Canadian Technical Report of Fisheries and Aquatic Sciences* 1245.
- Bilton, H.T., and G.L. Robins. 1971. Effects of feeding level on circulus formation on scales of young sockeye salmon (*Oncorhynchus nerka*). *Journal of the Fisheries Research Board of Canada* 28:861-865.
- Binns, A., and F. Eiserman. 1979. Quantification of fluvial trout habitat in Wyoming. *Transactions of the American Fisheries Society* 108:215-228.
- Bisson, P.A., and G.E. Davis. 1976. Production of juvenile chinook salmon, *Oncorhynchus tshawytscha*, in a heated model stream. *United States Fish and Wildlife Service, Fishery Bulletin* 74:763-774.
- Bjornn, T.C. 1971. Trout and salmon movements in two Idaho streams as related to temperature, food, stream flow, cover, and population density. *Transactions of the American Fisheries Society* 100:423-438.

- Bjornn, T.C. 1978. Survival, production, and yield of trout and chinook salmon in the Lemhi River, Idaho. University of Idaho, College of Forestry, Wildlife and Range Sciences Bulletin 27, Moscow.
- Bocking, R.C., and R.M. Peterman. 1988. Preseason forecasts of sockeye salmon (*Oncorhynchus nerka*): comparison of methods and economic considerations. Canadian Journal of Fisheries and Aquatic Sciences 45:1346-1354.
- Boecheler, J.L., and S.E. Jacobs. 1987. Catch and escapement of fall chinook salmon from Salmon River, Oregon, 1986. Oregon Department of Fish and Wildlife, Fish Research Project, Annual Progress Report, Portland.
- Bovee, K.D. 1982. A guide to stream habitat analysis using the instream flow incremental methodology. U.S. Fish and Wildlife Service, Instream Flow Information Paper 12, Fort Collins, Colorado.
- Bradford, M.J. 1994. Trends in the abundance of chinook salmon (*Oncorhynchus tshawytscha*) of the Nechako River, British Columbia. Canadian Journal of Fisheries and Aquatic Sciences 51:965-973.
- Bradford, M.J., G.C. Taylor, J.A. Allan, and P.S. Higgins. 1995. An experimental study of the stranding of juvenile coho salmon and rainbow trout during rapid flow decreases under winter conditions. North American Journal of Fisheries Management 15:473-479.
- Brannon, E.L., R.P. Whitman, and T.P. Quinn. 1984. Responses of returning adult coho salmon to home water and population specific odors. Transactions of the American Fisheries Society 115:726-735.
- Brett, J.R. 1952. Temperature tolerance in young Pacific salmon *Genus Oncorhynchus*. Journal of the Fisheries Research Board of Canada 9:265-323.
- Brett, J.R., W.C. Clarke, and J.E. Shelbourne. 1982. Experiments on thermal requirements for growth and food conversion efficiency of juvenile chinook salmon, *Oncorhynchus tshawytscha*. Canadian Technical Report of Fisheries and Aquatic Sciences 1127.
- Buckley, L.J., A.S. Smigielski, T.A. Halavik, and G.C. Laurence. 1990. Effects of water temperature on size and biochemical composition of winter flounder *Pseudopleuronectes americanus* at hatching and feeding initiation. United States National Marine Service, Fishery Bulletin 88:419-428.
- Buckman, M., and R.D. Ewing. 1982. Relationship between size and time of entry into the sea and gill (Na+K)-ATPase activity for juvenile spring chinook salmon. Transactions of the American Fisheries Society 111:681-687.
- Burger, C.V., R.L. Wilmot, and D.B. Wangaard. 1985. Comparison of spawning areas and times for two runs of chinook salmon (*Oncorhynchus tshawytscha*) in the Kenai River, Alaska. Canadian Journal of Fisheries and Aquatic Sciences 42:693-700.

- Byrne, A., T.C. Bjornn, and J.D McIntyre. 1992. Modeling the response of native steelhead to hatchery supplementation programs in an Idaho river. *North American Journal of Fisheries Management* 12:62-78.
- Carl, L.M. 1984. Chinook salmon (*Oncorhynchus tshawytscha*) density, growth, mortality, and movement in two Lake Michigan tributaries. *Canadian Journal of Zoology* 62:65-71.
- Carl, L.M., and Healey M.C. 1984. Differences in enzyme frequency and body morphology among three juvenile life history types of chinook salmon in the Nanaimo River, British Columbia. *Canadian Journal of Fisheries and Aquatic Sciences* 41:1070-1077.
- Cech, J.J., Jr., D.T. Castleberry, T.E. Hopkins, and J.H. Petersen. 1994. Northern squawfish, *Ptychocheilus oregonensis*, O<sub>2</sub> consumption rate and respiration model: effects of temperature and body size. *Canadian Journal of Fisheries and Aquatic Sciences* 51:8-12.
- Chadwick, E.M.P., T.R. Porter, and P. Downton. 1978. Analysis of growth of Atlantic salmon (*Salmo salar*) in a small Newfoundland river. *Journal of the Fisheries Research Board of Canada* 35:60-68.
- Chandler, G.L., and T.C. Bjornn. 1988. Abundance, growth, and interactions of juvenile steelhead relative to time of emergence. *Transactions of the American Fisheries Society* 117:432-443.
- Chapman, D.W. 1986. Salmon and steelhead abundance in the Columbia River in the nineteenth century. *Transactions of the American Fisheries Society* 115:662-670.
- Chapman, D.W. 1988. Critical review of variables used to define effects of fines in redds of large salmonids. *Transactions of the American Fisheries Society* 117:1-21.
- Chilcote, M.W., S.A. Leider, and J.J. Loch. 1986. Differential reproductive success of hatchery and wild summer-run steelhead under natural conditions. *Transactions of the American Fisheries Society* 115:726-735.
- Clarke, W.C., R.E. Withler, and J.E. Shelbourn. 1994. Inheritance of smolting phenotypes in backcrosses of hybrid stream-type x ocean-type chinook salmon (*Oncorhynchus tshawytscha*) subjected to sublethal exposures of gas-supersaturated water. *Estuaries* 17:13-25.
- Conder, A.L., and T.C. Annear. 1987. Test of weighted usable area estimates derived from a PHABSIM model for instream flow studies on trout streams. *North American Journal of Fisheries Management* 7:339-350.
- Connor, W.P., H.L. Burge, and D.H. Bennett. 1998. Detection of PIT-Tagged subyearling chinook salmon at a Snake River dam: implications for summer flow augmentation. *North American Journal of Fisheries Management* 18:530-536.
- Cooper, J.C., and A.T. Scholz. 1976. Homing of artificially imprinted steelhead (rainbow) trout, *Salmo gairdneri*. *Journal of the Fisheries Research Board of Canada* 33:826-829.

- Cousens, N.B.F., G.A. Thomas, C.G. Swann, and M.C. Healey. 1982. A review of salmon escapement estimation techniques. Canadian Technical Report of Fisheries and Aquatic Sciences 1108.
- Cox, S.P., and S.G. Hinch. 1997. Changes in size at maturity of Fraser River sockeye salmon (*Oncorhynchus nerka*) (1952-1993) and associations with temperature. Canadian Journal of Fisheries and Aquatic Sciences 54:1159-1165.
- Cramer, S.P., and B.P. McPherson, editors. 1983. Rogue Basin fisheries evaluation program, adult salmonid studies. Oregon Department of Fish and Wildlife, Fish Research Project DACW57-77-C-0027, Annual Progress Report, Portland.
- Cramer, S.P., T.D. Satterthwaite, R.R. Boyce, and B.P. McPherson. 1985. Lost Creek Dam fisheries evaluation phase I completion report. Volume I. Impacts of Lost Creek Dam on the biology of anadromous salmonids in the Rogue River. Oregon Department of Fish and Wildlife, Fish Research Project DACW57-77-C-0027, Portland.
- Cushman, R.M. 1985. Review of ecological effects of rapidly varying flows downstream from hydroelectric facilities. North American Journal of Fisheries Management 5:330-339.
- DeVries, P. 1997. Riverine salmonid egg burial depths: review of published data and implications for scour studies. Canadian Journal of Fisheries and Aquatic Sciences 54:1685-1698.
- Donaldson, L.R., and D. Menasveta. 1961. Selective breeding of chinook salmon. Transactions of the American Fisheries Society 90:160-164.
- Doyle, R.W., A.J. Talbot, and R.R. Nicholas 1987. Statistical interrelation of length, growth, and scale circulus spacing: appraisal of a growth rate estimator for fish. Canadian Journal of Fisheries and Aquatic Sciences 44:1520-1528.
- Eaton, J.G., and six coauthors. 1994. A field information based system for estimating fish temperature tolerances. Fisheries 20(4):10-18.
- Elwood, J.W., and T.F. Waters. 1969. Effects of floods on food consumption and production rates of a stream brook trout population. Transactions of the American Fisheries Society 98:253-262.
- Erickson, D.L., and E.K. Pikitch. 1994. Incidental catch of chinook salmon in commercial bottom trawls off the U.S. west coast. North American Journal of Fisheries Management 15:550-563.
- Erman, D.C., E.D. Andrews, and M. Yoder-Williams. 1988. Effects of winter floods on fishes in the Sierra Nevada. Canadian Journal of Fisheries and Aquatic Sciences 45:2195-2200.
- Evans, G.T., and J.B. Dempson. 1986. Calculating the sensitivity of a salmonid population model. Canadian Journal of Fisheries and Aquatic Sciences 43:863-868.

- Evenson, M.D., R.D. Ewing, E.K. Birks, A.R. Hemmingsen, and J. Dentler. 1981. Cole Rivers Hatchery evaluation. Oregon Department of Fish and Wildlife, Fish Research Project AFS-71-4, Annual Progress Report, Portland.
- Evenson, M.D., and R.D. Ewing. 1988. Cole Rivers Hatchery evaluation. Oregon Department of Fish and Wildlife, Fish Research Project AFS-78-1, Annual Progress Report, Portland.
- Evenson, M.D., and R.D. Ewing. 1990. Cole Rivers Hatchery evaluation. Oregon Department of Fish and Wildlife, Fish Research Project AFS-78-1, Annual Progress Report, Portland.
- Everest, F.H., and D.W. Chapman. 1972. Habitat selection and spatial interaction by juvenile chinook salmon and steelhead trout in two Idaho streams. *Journal of the Fisheries Research Board of Canada* 29:91-100.
- Ewing, R.D., S.L. Johnson, H.J. Pribble, and J.A. Lichatowich. 1979. Temperature and photoperiod effects on gill (Na+K)-ATPase activity in chinook salmon (*Oncorhynchus tshawytscha*). *Journal of the Fisheries Research Board of Canada* 36:1347-1353.
- Fisher, J.P., and W.G. Pearcy. 1988. Growth of juvenile coho salmon (*Oncorhynchus kisutch*) off Oregon and Washington, USA, in years of differing coastal upwelling. *Canadian Journal of Fisheries and Aquatic Sciences* 45:1036-1044.
- Fisher, J.P., and W.G. Pearcy. 1990. Spacing of scale circuli versus growth rate in young coho salmon. *United States National Marine Fisheries Service, Fishery Bulletin* 88:637-643.
- Fleming, I.A., and M.R. Gross. 1994. Breeding competition in a Pacific salmon (coho: *Oncorhynchus kisutch*): measures of natural and sexual selection. *Evolution* 48:637-657.
- Folmar, L.C., and W.W. Dickhoff. 1980. The parr-smolt transformation (smoltification) and seawater adaptation in salmonids: a review of selected literature. *Aquaculture* 21:1-37.
- Forbes, L.S., and R.M. Peterman. 1994. Simple size-structured models of recruitment and harvest in Pacific salmon (*Oncorhynchus* spp.). *Canadian Journal of Fisheries and Aquatic Sciences* 51:603-616.
- Friedland, K.D., and R.E. Haas. 1996. Marine post-smolt growth and age at maturity of Atlantic salmon. *Journal of Fish Biology* 48:1-15.
- Friedland, K.D., R.E. Haas, and T.F. Sheehan. 1996. Post-smolt growth, maturation, and survival of two stocks of Atlantic salmon. *United States National Marine Fisheries Service, Fishery Bulletin* 94:654-663.
- Friday, J., and S.J. Miller. 1984. Statistical summaries of streamflow data in Oregon. Volume 2. Western Oregon. *United States Geological Survey, Open-file report* 84-454, Portland.

- Fukushima, M., and W.W. Smoker. 1997. Determinants of stream life, spawning efficiency, and spawning habitat in pink salmon in the Auke Lake system, Alaska. *Canadian Journal of Fisheries and Aquatic Sciences* 54:96-104.
- Fukuwaka, M., and M. Kaeriyama. 1997. Scale analyses to estimate somatic growth in sockeye salmon, *Oncorhynchus nerka*. *Canadian Journal of Fisheries and Aquatic Sciences* 54:631-636.
- Fustish, C.A., S.E. Jacobs, B.P. McPherson, and P.A. Frazier. 1988. Applegate Dam Evaluation. Phase I Completion Report. Impacts of Applegate Dam on the biology of anadromous salmonids in the Applegate River. Oregon Department of Fish and Wildlife, Fish Research Project DACW57-77-C-0033, Portland.
- Fustish, C.A., S.E. Jacobs, and A. McGie. 1994. Influence of Applegate Dam on fall chinook salmon and recommendations for dam operation. Phase II Completion Report. Draft. Oregon Department of Fish and Wildlife, Fish Research Project DACW57-77-C-0027, Portland.
- Gall, G.A.E., J. Baltodano, and N. Huang. 1988. Heritability of age at spawning for rainbow trout. *Aquaculture* 68:93-102.
- Gangmark, H.A., and R.G. Bakkala. 1960. A comparative study of unstable and stable (artificial channel) spawning streams for incubating king salmon at Mill Creek. *California Fish and Game* 46:151-164.
- Giberson, D.J., and D. Caissie. 1998. Stream habitat hydraulics: interannual variability in three reaches of Catamaran Brook, New Brunswick. *Canadian Journal of Fisheries and Aquatic Sciences* 55:485-494.
- Gilbert, C.H., and W.H. Rich. 1927. Investigations concerning red salmon runs to the Karluk River, Alaska. *Bulletin of the United States Bureau of Fisheries* Number 43 Part II.
- Gilhousen, P. 1990. Prespawning mortalities of sockeye salmon in the Fraser River system and possible causal factors. *International Pacific Salmon Fishery Commercial Bulletin* Number 26.
- Godin, J-G.J. 1981. Migrations of salmonid fishes during early life history phases: daily and annual timing. Pages 22-50 *in* E.L. Brannon and E.O. Salo, editors. *Proceedings of a symposium on salmon and trout migratory behavior*. University of Washington, Seattle.
- Graybill, J.P., and ten coauthors. 1979. Assessment of the reservoir-related effects of the Skagit project on the downstream fisheries of the Skagit River, Washington. University of Washington, Fisheries Resource Research Institute. FRIUN-7505, Seattle, Washington.
- Green, P.E.J., and P.D.M. Macdonald. 1987. Analysis of mark-recapture data from hatchery-raised salmon using log-linear models. *Canadian Journal of Fisheries and Aquatic Sciences* 44:316-326.
- Grizzle, J.M. 1981. Effects of hypolimnetic discharge on fish health below a reservoir. *Transactions of the American Fisheries Society* 110:29-43.

- Gudjonsson, S., S.M. Einarsson, T. Antonsson, and G. Gudbergsson. 1995. Relation of grilse to salmon ratio to environmental changes in several wild stocks of Atlantic salmon (*Salmo salar*) in Iceland. *Canadian Journal of Fisheries and Aquatic Sciences* 52:1385-1398.
- Hamlin, D.E., and J.M. Nestler. 1987. Development of a model to predict longitudinal water temperatures for the Rogue River, Oregon. Miscellaneous Paper EL-87-15, United States Army Corps of Engineer Waterways Experiment Station, Vicksburg, Mississippi.
- Hamlin-Tillman, D.E., and C. Haake. 1990. Predicted water quality impacts of impoundments on the Rogue River, Oregon. United States Army Corps of Engineers Waterways Experiment Station, Technical Report EL-90-5, Vicksburg, Mississippi.
- Hankin, D.G. 1990. Effects of month of release of hatchery-reared chinook salmon on size at age, maturation schedule, and fishery contribution. Oregon Department of Fish and Wildlife, Information Reports (Fish) 90-4, Portland.
- Hankin, D.G., and M.C. Healey. 1986. Dependence of exploitation rates for maximum yield and stock collapse on age and sex structure of chinook salmon (*Oncorhynchus tshawytscha*) stocks. *Canadian Journal of Fisheries and Aquatic Sciences* 43:1746-1759.
- Hankin, D.G., J.W. Nicholas, and T.W. Downey. 1993. Evidence for inheritance of age of maturity in chinook salmon *Oncorhynchus tshawytscha*. *Canadian Journal of Fisheries and Aquatic Sciences* 50:347-358.
- Hartman, G.F., B.C. Andersen, and J.C. Scrivener. 1982. Seaward movement of coho salmon (*Oncorhynchus kisutch*) fry in Carnation Creek, an unstable coastal stream in British Columbia. *Canadian Journal of Fisheries and Aquatic Sciences* 39:588-597.
- Hartman, G.F., J.C. Scrivener, and M.J. Miles. 1996. Impacts of logging in Carnation Creek, a high energy coastal stream in British Columbia, and their implication for restoring fish habitat. *Canadian Journal of Fisheries and Aquatic Sciences* 53(Supplement 1):237-251.
- Harvey, B.C. 1987. Susceptibility of young-of-the-year fishes to downstream displacement by flooding. *Transactions of the American Fisheries Society* 116:851-855.
- Hatch, D.R., M. Schwartzberg, and P.R. Mundy. 1994. Estimation of Pacific salmon escapement with a time-lapse video recording technique. *North American Journal of Fisheries Management* 14:626-635.
- Havey, K.A., and R.M. Davis. 1970. Factors influencing standing crops and survival of juvenile salmon at Barrows Stream, Maine. *Transactions of the American Fisheries Society* 99:297-310.
- Healey, M.C. 1980. Utilization of the Nanaimo River estuary by juvenile chinook salmon (*Oncorhynchus tshawytscha*). United States National Marine Fisheries Service, Fishery Bulletin 77:653-668.

- Healey, M.C. 1982. Timing and intensity of size-selective mortality of juvenile chum salmon (*Oncorhynchus keta*) during early sea life. Canadian Journal of Fisheries and Aquatic Sciences 39:952-957.
- Healey, M.C. 1983. Coastwide distribution and ocean migration patterns of stream- and ocean-type chinook salmon, *Oncorhynchus tshawytscha*. Canadian Field-Naturalist 97:427-433.
- Healey, M.C., and W.R. Heard. 1984. Inter- and intra-population variation in the fecundity of chinook salmon (*Oncorhynchus tshawytscha*) and its relevance to life history theory. Canadian Journal of Fisheries and Aquatic Sciences 41:476-483.
- Heggberget, T.G. 1988. Timing of spawning in Norwegian Atlantic salmon (*Salmo salar*). Canadian Journal of Fisheries and Aquatic Sciences 45:845-849.
- Heming, T.A. 1982. Effects of temperature on utilization of yolk by chinook salmon (*Oncorhynchus tshawytscha*) eggs and alevins. Canadian Journal of Fisheries and Aquatic Sciences 39:184-190.
- Heming, T.A., J.E. McInerney, and D.F. Alderdice. 1982. Effect of temperature on initial feeding in alevins of chinook salmon (*Oncorhynchus tshawytscha*). Journal of the Fisheries Research Board of Canada 36:1554-1562.
- Hicks, R.H., and L.D. Calvin. 1964. An evaluation of the punch card method of estimating salmon-steelhead sport catch. Agricultural Experiment Station Technical Report 81, Oregon State University, Corvallis.
- Higgins, P.S., and M.S. Bradford. 1996. Evaluation of a large scale fish salvage to reduce the impacts of controlled flow reduction in a regulated river. North American Journal of Fisheries Management 16:666-673.
- Hinch, S.G., and six coauthors. 1995. Potential effects of climate change on marine growth and survival of Fraser River sockeye salmon. Canadian Journal of Fisheries and Aquatic Sciences 52:2651-2659.
- Hindar, K., N. Ryman, and F. Utter. 1991. Genetic effects of cultured fish on natural fish populations. Canadian Journal of Fisheries and Aquatic Sciences 48:945-957.
- Holt, R.A., J.E. Saunders, J.L. Zinn, J.L. Fryer, and K.S. Pilcher. 1975. Relation of water temperature to *Flexibacter columnaris* infection in steelhead trout (*Salmo gairdneri*), coho (*Oncorhynchus kisutch*) and chinook (*O. tshawytscha*) salmon. Journal of the Fisheries Research Board of Canada 32:1553-1559.
- Holtby, L.B. 1988. Effects of logging on stream temperatures in Carnation Creek, British Columbia, and associated impacts on the coho salmon (*Oncorhynchus kisutch*). Canadian Journal of Fisheries and Aquatic Sciences 45:502-515



- Holtby, L.B., B.C. Andersen, and R.K. Kadowaki. 1990. Importance of smolt size and early ocean growth to interannual variability in marine survival of coho salmon (*Oncorhynchus kisutch*). Canadian Journal of Fisheries and Aquatic Sciences 47:2181-2194.
- Holtby, L.B., and M.C. Healey. 1986. Selection for adult size in female coho salmon (*Oncorhynchus kisutch*). Canadian Journal of Fisheries and Aquatic Sciences 43:1946-1959.
- Holtby, L.B., R.K. Kadowaki, and K.S. Simpson. 1992. Factors affecting the vulnerability of juvenile coho salmon (*Oncorhynchus kisutch*) and chinook salmon (*O. tshawytscha*) in a saltwater sport fishery. Canadian Journal of Fisheries and Aquatic Sciences 49:2164-2178.
- Horrall, R.M. 1981. Behavioral stock-isolating mechanisms in Great Lakes fishes with special reference to homing and site imprinting. Canadian Journal of Fisheries and Aquatic Sciences 38:1481-1496.
- Hynes, H.B.N. 1970. The ecology of running waters. University of Toronto Press, Toronto.
- Irvine, J.R., I.G. Jowett, and D. Scott. 1987. A test of the instream flow incremental methodology for underyearling rainbow trout, *Salmo gairdnerii*, in experimental New Zealand streams. New Zealand Journal of Marine and Freshwater Resources 21:35-40.
- Jacobs, S.L., W.T. Noll, and J.D. Rodgers. 1984. Increase in growth of juvenile spring chinook salmon (*Oncorhynchus tshawytscha*) rearing immediately below Lost Creek Dam on the Rogue River. Oregon Department of Fish and Wildlife, Information Reports (Fish) 84-6, Portland.
- Jensen, A.L. 1986. Functional regression and correlation analysis. Canadian Journal of Fisheries and Aquatic Sciences 43:1742-1745.
- Johnson, S.L. 1988. The effects of El Niño on Oregon's coho (*Oncorhynchus kisutch*) and chinook (*O. tshawytscha*) salmon. Fisheries Research 6:105-123.
- Johnsson, J.I., and M.V. Abrahams. 1991. Interbreeding with domestic strain increases foraging under threat of predation in juvenile steelhead trout (*Oncorhynchus mykiss*): an experimental study. Canadian Journal of Fisheries and Aquatic Sciences 48:243-247.
- Johnston, I.A., and H.A. McLay. 1997. Temperature and family effects on muscle cellularity at hatch and first feeding in Atlantic salmon (*Salmo salar* L.). Canadian Journal of Zoology 75:64-74.
- Jonasson, B.C., and R.B. Lindsay. 1988. Fall chinook salmon in the Deschutes River, Oregon. Oregon Department of Fish and Wildlife, Information Reports (Fish) 88-6, Portland.
- Kondolf, G.M., J.C. Vick, and T.M. Ramirez. 1996. Salmon spawning habitat rehabilitation on the Merced River, California: an evaluation of project planning and performance. Transactions of the American Fisheries Society 125:899-912.

- Koo, T.S.Y., and A. Isarankura. 1968. Objective studies of scales of Columbia River chinook salmon, *Oncorhynchus tshawytscha* (Walbaum). United States Fish and Wildlife Service, Fishery Bulletin 66:165-180.
- Kope, R.G. 1987. Separable virtual population analysis of Pacific salmon with application to marked chinook salmon, *Oncorhynchus tshawytscha*, from California's Central Valley. Canadian Journal of Fisheries and Aquatic Sciences 44:1213-1220.
- Korman, J., and P.S. Higgins. 1997. Utility of escapement time-series data for monitoring the response of salmon populations to habitat alteration. Canadian Journal of Fisheries and Aquatic Sciences 54:2058-2067.
- Kwain, W. and E. Thomas. 1984. The first evidence of spring spawning by chinook salmon in Lake Superior. North American Journal of Fisheries Management 4:227-228.
- Kyle, G.B., J.P. Koenings, and B.M. Barrett. 1988. Density-dependent, trophic level responses to an introduced run of sockeye salmon (*Oncorhynchus tshawytscha*) at Frazier Lake, Alaska. Canadian Journal of Fisheries and Aquatic Sciences 45:856-867.
- Labelle, M., C.J. Walters, and B.E. Riddell. 1997. Ocean survival and exploitation of coho salmon (*Oncorhynchus kisutch*) stocks from the east coast of Vancouver Island, British Columbia. Canadian Journal of Fisheries and Aquatic Sciences 54:1433-1449.
- Larkin, P.A. 1981. A perspective on population genetics and salmon management. Canadian Journal of Fisheries and Aquatic Sciences 38:1469-1475.
- Leider, S.A., M.W. Chilcote, and J.J. Loch. 1986. Comparative life history characteristics of hatchery and wild steelhead trout (*Salmo gairdneri*) of summer and winter races in the Kalama River, Washington. Canadian Journal of Fisheries and Aquatic Sciences 43:1398-1409.
- Leider, S.A., P.L. Hulett, J.J. Loch, and M.W. Chilcote. 1990. Electrophoretic comparison of the reproductive success of naturally spawning transplanted and wild steelhead trout through the returning adult stage. Aquaculture 88:239-252.
- Levings, C.D., C.D. McAllister, and B.D. Chang. 1986. Differential use of the Campbell River estuary, British Columbia, by wild and hatchery-reared juvenile chinook salmon (*Oncorhynchus tshawytscha*). Canadian Journal of Fisheries and Aquatic Sciences 43:1386-1397.
- Lewis, M.A. 1997. Stock assessment of anadromous salmonids. Oregon Department of Fish and Wildlife, Annual Progress Report, Portland.
- Li, J.C.R. 1948. A sampling plan for estimating the number of fish crossing Gold Ray Dam on the Rogue River. Unpublished report to the Oregon State Game Commission, Portland.

- Lindsay, R.B., B.C. Jonasson, and R.K. Schroeder. 1989. Spring chinook salmon in the Deschutes River. Oregon Department of Fish and Wildlife, Information Reports (Fish) 89-4, Portland.
- Lindsay, R.B., W.J. Knox, M.W. Flesher, E.A. Olsen, and L.S. Lutz. 1986. Study of wild spring chinook salmon in the John Day River System. Oregon Department of Fish and Wildlife, Fish Research Project DE-A179-83BP397996, Final Report, Portland.
- Lister, D.B., D.G. Hickey, and I. Wallace. 1981. Review of the effects of enhancement strategies on the homing, straying, and survival of Pacific salmonids, volumes I & II. D.B. Lister and Associates, Ltd., Vancouver, British Columbia.
- Lister, D.B., and C.E. Walker. 1966. The effect of flow control on freshwater survival of chum, coho, and chinook salmon in the Big Qualicum River. Canadian Fish Culturist 37:3-25.
- Lloyd, D.S. 1987. Turbidity as a water quality standard for salmonid habitats in Alaska. North American Journal of Fisheries Management 7:34-45.
- Major, R.L., and J.L. Mighell. 1969. Egg-to-migrant survival of spring chinook salmon (*Oncorhynchus tshawytscha*) in the Yakima River, Washington. United States Fish and Wildlife Service, Fishery Bulletin 67:347-359.
- Margulies, D. 1989. Effects of food concentration and temperature on development, growth, and survival of white perch, *Morone americana* eggs and larvae. United States National Marine Service, Fishery Bulletin 87:63-72.
- Mathews, S.B., and R. Buckley. 1976. Marine mortality of Puget Sound coho salmon (*Oncorhynchus kisutch*). Journal of the Fisheries Research Board of Canada 33:77-1684.
- Mathews, S.B., and Y. Ishida. 1989. Survival, ocean growth, and ocean distribution of differentially timed releases of hatchery coho salmon (*Oncorhynchus kisutch*) smolts migrating from the Keogh River watershed on northern Vancouver Island. Canadian Journal of Fisheries and Aquatic Sciences 46:1216-1226.
- Mathews, S.B., and F.W. Olson. 1980. Factors affecting Puget Sound coho salmon (*Oncorhynchus kisutch*) runs. Canadian Journal of Fisheries and Aquatic Sciences 39:1444-1452.
- McMichael, G.A., and T.N. Pearsons. 1998. Effects of wild juvenile spring chinook salmon on growth and abundance of wild rainbow trout. Transactions of the American Fisheries Society 127:261-274.
- McPhee, M.V., and T.P. Quinn. 1998. Factors affecting the duration of nest defense and reproductive lifespan of female sockeye salmon, *Oncorhynchus nerka*. Environmental Biology of Fishes 51:369-375.
- Mathur, D., W.H. Bason, E.J. Purdy, Jr., and C.A. Silver. 1985. A critique of the instream flow incremental methodology. Canadian Journal of Fisheries and Aquatic Sciences 42:825-831.

- Mesa, M.G. 1991. Variation in feeding, aggression, and position choice between hatchery and wild cutthroat trout in an artificial stream. *Transactions of the American Fisheries Society* 120:723-727.
- Miller, R.J., and E.L. Brannon 1981. The origin and development of life history patterns in Pacific salmonids. Pages 219-227 *in* E.L. Brannon and E.O. Salo, editors. *Proceedings of a symposium on salmon and trout migratory behavior*. University of Washington, Seattle.
- Mitchum, D.L., L.E. Sherman, and G.T. Baxter. 1979. Bacterial kidney disease in feral populations of brook trout (*Salvelinus fontinalis*), brown trout (*Salmo trutta*), and rainbow trout (*Salmo gairdneri*). *Journal of the Fisheries Research Board of Canada* 36:1370-1376.
- Moffatt, R.L., Wellman, R.E., and J.M. Gordon. 1990. Statistical summaries of streamflow data in Oregon: Volume 1. Monthly and annual streamflow, and flow-duration values. United States Geological Survey, Open File Report 90-118, Portland, Oregon.
- Montgomery, D.R., J.M. Buffington, N.P. Peterson, D. Schuett-Hames, and T.P. Quinn. 1996. Stream-bed scour, egg burial depths, and the influence of salmonid spawning on bed surface mobility and embryo survival. *Canadian Journal of Fisheries and Aquatic Sciences* 53:1061-1070.
- Moyle, P.B., and D.M. Baltz. 1985. Microhabitat use by an assemblage of California stream fishes: developing criteria for instream flow determinations. *Transactions of the American Fisheries Society* 114:695-704.
- Murphy, M.L. 1985. Die-offs of pre-spawn adult pink salmon and chum salmon in southeastern Alaska. *North American Journal of Fisheries Management* 5:302-308.
- Murray, C.B., and T.D. Beacham. 1987. The development of chinook *Oncorhynchus tshawytscha* and chum salmon *Oncorhynchus keta* embryos and alevins under varying temperature regimes. *Canadian Journal of Zoology* 65:2672-2681.
- Murray, C.B., T.D. Beacham, and J.D. McPhail. 1990. Influence of parental stock and incubation temperature on the early development of coho salmon (*Oncorhynchus kisutch*) in British Columbia. *Canadian Journal of Zoology* 68:347-358.
- Myers, J.M., and ten coauthors. 1998. Status review of chinook salmon from Washington, Idaho, Oregon, and California. National Oceanic and Atmospheric Administration, Technical Memorandum NMFS-NWFSC-35, Springfield, Virginia.
- Mysak, L.A. 1986. El Niño, interannual variability and fisheries in the northeast Pacific. *Canadian Journal of Fisheries and Aquatic Sciences* 43:464-497.

- Nathanailides, C., O. Lopez-Albors, and N.C. Stickland. 1995. Influence of prehatch temperature on the development of muscle cellularity in posthatch Atlantic salmon (*Salmo salar*). Canadian Journal of Fisheries and Aquatic Sciences 52:675-680.
- Neilson, J.D., and C.E. Banford. 1983. Chinook salmon (*Oncorhynchus tshawytscha*) spawner characteristics in relation to redd physical features. Canadian Journal of Zoology 61:1524-1531.
- Neilson, J.D., and G.H. Geen. 1986. First-year growth rate of Sixes River chinook salmon as inferred from otoliths: effects on mortality and age at maturity. Transactions of the American Fisheries Society 115:28-33.
- Neilson, J.D., G.H. Geen, and D. Bottom. 1985. Estuarine growth of juvenile chinook salmon (*Oncorhynchus tshawytscha*) as inferred from otolith microstructure. Canadian Journal of Fisheries and Aquatic Sciences 42:899-908.
- Neter, J., and W. Wasserman. 1974. Applied linear statistical models. Irwin, Homewood, Illinois.
- Nicholas, J.W., and D.G. Hankin. 1988. Chinook salmon populations in Oregon coastal river basins: description of life histories and assessment of recent trends in run strengths. Oregon Department of Fish and Wildlife, Information Reports (Fish) 88-1, Portland.
- Nicieza, A.G., and F. Braña. 1993. Relationships among smolt size, marine growth, and sea age at maturity of Atlantic salmon (*Salmo salar*) in northern Spain. Canadian Journal of Fisheries and Aquatic Sciences 50:1632-1640.
- Nickelson, T.E. 1986. Influences of upwelling, ocean temperature, and smolt abundance on marine survival of coho salmon (*Oncorhynchus kisutch*) in the Oregon Production Area. Canadian Journal of Fisheries and Aquatic Sciences 43:527-535.
- Nickelson, T.E., M.F. Solazzi, and S.L. Johnson. 1986. Use of hatchery coho salmon (*Oncorhynchus kisutch*) presmolts to rebuild wild populations in Oregon coastal streams. Canadian Journal of Fisheries and Aquatic Sciences 43:2443-2449.
- ODFW (Oregon Department of Fish and Wildlife). 1990. Effects of Lost Creek Dam on winter steelhead in the Rogue River. Phase II Completion Report. Oregon Department of Fish and Wildlife, Fish Research Project DACW 57-77-C-0033, Completion Report, Portland.
- ODFW (Oregon Department of Fish and Wildlife). 1991a. Effects of Lost Creek Dam on the distribution and time of chinook salmon spawning in the Rogue River upstream of Gold Ray Dam. Oregon Department of Fish and Wildlife, Fish Research Project DACW 57-77-C-0033, Special Report, Portland.
- ODFW (Oregon Department of Fish and Wildlife). 1991b. Effects of Lost Creek Dam on coho salmon in the Rogue River. Phase II Completion Report. Oregon Department of Fish and Wildlife, Fish Research Project DACW 57-77-C-0033, Completion Report, Portland.

- ODFW (Oregon Department of Fish and Wildlife). 1992. Effects of Lost Creek Dam on fall chinook salmon in the Rogue River. Phase II Completion Report. Oregon Department of Fish and Wildlife, Fish Research Project DACW 57-77-C-0033, Completion Report, Portland.
- ODFW (Oregon Department of Fish and Wildlife). 1994. Effects of Lost Creek Dam on summer steelhead in the Rogue River. Phase II Completion Report. Oregon Department of Fish and Wildlife, Fish Research Project DACW 57-77-C-0033, Completion Report, Portland.
- ODFW (Oregon Department of Fish and Wildlife). 1997. Salmon bycatch in the Pacific whiting fisheries Oregon Department of Fish and Wildlife, Marine Finfish and Ocean Salmon Programs, Newport.
- ODWR (Oregon Department of Water Resources). 1985. Rogue River Basin Study. Oregon Department of Water Resources, Salem.
- Orsi, J.A., and H.W. Jaenicke. 1996. Marine distribution and origin of prerecruit chinook salmon, *Oncorhynchus tshawytscha*, in southeastern Alaska. United States National Marine Service, Fishery Bulletin 94:482-497.
- Parker, R.R. 1971. Size-selective predation among juvenile salmonid fishes in a British Columbia inlet. Journal of the Fisheries Research Board of Canada 28:1503-1510.
- Parker, R.R., and P.A. Larkin. 1959. A concept of growth in fishes. Journal of the Fisheries Research Board of Canada 16:721-745.
- Parsley, M.J., D.E. Palmer, and R.W. Burkhardt. 1989. Variation in capture efficiency of a beach seine for small fishes. North American Journal of Fisheries Management 9:239-244.
- Pascual, M.A., T.P. Quinn, and H. Fuss. 1995. Factors affecting the homing of fall chinook salmon from Columbia River hatcheries. Transactions of the American Fisheries Society 124:308-320.
- Peterman, R.M. 1982. Model of salmon age structure and its use in preseason forecasting and studies of marine survival. Canadian Journal of Fisheries and Aquatic Sciences 39:1444-1452.
- Peterman, R.M., and G.J. Steer. 1981. Relation between sport-fishing catchability coefficients and salmon abundance. Transactions of the American Fisheries Society 110:585-593.
- Petersen, J.H., and D.L. DeAngelis. 1992. Functional response and capture timing in an individual-based model: predation by northern squawfish (*Ptychocheilus oregonensis*) on juvenile salmonids in the Columbia River. Canadian Journal of Fisheries and Aquatic Sciences 48:2491-2498.
- PFMC (Pacific Fishery Management Council). 1998a. Preseason report I. Stock abundance analysis for the 1998 ocean salmon fisheries. Pacific Fishery Management Council, Portland, Oregon.
- PFMC (Pacific Fishery Management Council). 1998b. Review of 1997 ocean salmon fisheries. Pacific Fishery Management Council, Portland, Oregon.

- Pope, J.G. 1972. An investigation of the accuracy of virtual population analysis using cohort analysis. *International Commission of Northwest Atlantic Fisheries Resources Bulletin* 9:65-74.
- Quinn, T.P., and K. Fresh. 1984. Homing and straying in chinook salmon (*Oncorhynchus tshawytscha*) from Cowlitz River Hatchery, Washington. *Canadian Journal of Fisheries and Aquatic Sciences* 41:1078-1082.
- Quinn, T.P., S. Hodgson, and C. Peven. 1997. Temperature, flow, and the migration of adult sockeye salmon (*Oncorhynchus nerka*) in the Columbia River. *Canadian Journal of Fisheries and Aquatic Sciences* 54:1349-1360.
- Quinn, T.P., and M.J. Unwin. 1993. Variation in life history patterns among New Zealand chinook salmon (*Oncorhynchus tshawytscha*) populations. *Canadian Journal of Fisheries and Aquatic Sciences* 50:1414-1421.
- Ratti, F. 1979. Natural resources of Rogue estuary. Oregon Department of Fish and Wildlife, Estuary Inventory Report 2-8, Portland.
- Reimers, P.E. 1973. The length of residence of juvenile fall chinook salmon in Sixes River, Oregon. *Fish Commission of Oregon Research Reports* 4(2)3-43.
- Reimers, P.E., and G.L. Concannon. 1977. Extended residence of hatchery-released juvenile fall chinook salmon in Elk River, Oregon. Oregon Department of Fish and Wildlife, Information Reports (Fish) 77-2, Portland.
- Reimers, P.E., and R.E. Loeffel. 1967. The length of residence of juvenile fall chinook salmon in selected Columbia River tributaries. *Fish Commission of Oregon, Research Briefs* 13:5-19.
- Reisenbichler, R.R. 1987. Basis for managing the harvest of chinook salmon. *North American Journal of Fisheries Management* 7:589-591.
- Reisenbichler, R.R., and J.D. McIntyre. 1977. Genetic differences in growth and survival of juvenile hatchery and wild steelhead trout, *Salmo gairdneri*. *Journal of the Fisheries Research Board of Canada* 34:123-128.
- Rich, W.H. 1925. Growth and degree of maturity of chinook salmon in the ocean. *Bulletin of the United States Bureau of Fisheries* 41:15-90.
- Richards, C., and P.J. Cernera. 1989. Dispersal and abundance of hatchery reared and naturally spawned juvenile chinook salmon in an Idaho stream. *North American Journal of Fisheries Management* 9:345-351.
- Ricker, W.E. 1969. Effects of size-selective mortality and sampling bias on estimates of growth, mortality, production, and yield. *Journal of the Fisheries Research Board of Canada* 26:479-541.
- Ricker, W.E. 1972. Heredity and environmental factors affecting certain salmonid populations. Pages 27-160 *in* The stock concept in Pacific salmon. MacMillan Lectures in Fisheries, University of British Columbia, Vancouver.

- Ricker, W.E. 1973. Linear regressions in fishery research. *Journal of the Fisheries Research Board of Canada* 30:409-434.
- Ricker, W.E. 1975. Computation and interpretation of biological statistics of fish populations. *Fisheries Research Board of Canada Bulletin* 191.
- Ricker, W.E. 1976. Review of the rate of growth and mortality of Pacific salmon in salt water, and non-catch mortality caused by fishing. *Journal of the Fisheries Research Board of Canada* 33:1483-1524.
- Ricker, W.E. 1980. Causes of the decrease in age and size of chinook salmon (*Oncorhynchus tshawytscha*). *Canadian Technical Report of Fisheries and Aquatic Sciences* 944.
- Rivers, C.M. 1964. Rogue River fisheries. Oregon State Game Commission, unpublished manuscript, Portland.
- Roff, D.A. 1984. The evolution of life history parameters in teleosts. *Canadian Journal of Fisheries and Aquatic Sciences* 41:989-1000.
- Roffe, T.J., and B.R. Mate. 1984. Abundances and feeding habits of pinnipeds in the Rogue River, Oregon. *Journal of Wildlife Management* 48:1262-1274.
- Rosenberg, D.M., R.A. Bodaly, R.E. Hecky, and R.W. Newbury. 1986. The environmental assessment of hydroelectric impoundments and diversions in Canada. In M.C. Healey and R.R. Wallace, editors. *Canadian aquatic resources*. *Canadian Bulletin of Fisheries and Aquatic Sciences* 215.
- Satterthwaite, T.D. 1987. Rogue basin fisheries evaluation program, effects of Lost Creek Dam on spring chinook salmon in the Rogue River, Oregon: An update. Oregon Department of Fish and Wildlife, Fish Research Project DACW57-77-C-0027, Portland.
- Satterthwaite, T.D. 1995. Effects of boat traffic on juvenile salmonids in the Rogue River. Oregon Department of Fish and Wildlife, Fish Research Project (unnumbered), Completion Report, Portland.
- Satterthwaite, T.D., and G.D. Apke. 1993. Evaluation of spring chinook salmon in relation to the operation of Lost Creek Dam. Oregon Department of Fish and Wildlife, Fish Research Project (unnumbered), Portland.
- Satterthwaite, T.D., B.P. McPherson, and M.W. Flesher. 1992. Effects of Elk Creek Dam on fishery resources in the Rogue River. Completion Report for preimpoundment research. Oregon Department of Fish and Wildlife, Fish Research Project DACW 57-77-C-0033, Completion Report, Portland.
- Satterthwaite, T.D., B.P. McPherson, P.A. Frazier, and S.P. Cramer. 1985. Rogue Basin fisheries evaluation program, Lost Creek Dam studies. Oregon Department of Fish and Wildlife, Fish Research Project DACW57-77-C-0027, Biennial Progress Report, Portland.
- Scarnecchia, D.L. 1984. Forecasting yields of two-sea-winter Atlantic salmon (*Salmo salar*) from Icelandic rivers. *Canadian Journal of Fisheries and Aquatic Sciences* 41:1234-1240.



- Schluchter, M.D., and J.A. Lichatowich. 1977. Juvenile life histories of Rogue River spring chinook salmon, (*Oncorhynchus tshawytscha* Walbaum) as determined by scale analysis. Oregon Department of Fish and Wildlife, Information Reports (Fish) 77-5, Portland.
- Schoettger, R.A., and E.W. Steucke, Jr. 1970. Synergic mixtures of MS-222 and quinaldine as anesthetics for rainbow trout and in northern pike. *Progressive Fish-Culturist* 32:202-205.
- Scrivener, J.C., and B.C. Andersen. 1984. Logging impacts and some mechanisms that determine the size of spring and summer populations of coho salmon fry (*Oncorhynchus kisutch*) in Carnation Creek, British Columbia. *Canadian Journal of Fisheries and Aquatic Sciences* 41:1097-1105.
- Scrivener, J.C., and M.J. Brownlee. 1989. Effects of forest harvesting on spawning gravel and incubation survival of chum (*Oncorhynchus keta*) and coho salmon (*O. kisutch*) in Carnation Creek, British Columbia. *Canadian Journal of Fisheries and Aquatic Sciences* 46:681-696
- Seegrist, D.W., and R. Gard. 1972. Effects of floods on trout in Sagehen Creek, California. *Transactions of the American Fisheries Society* 101:478-482.
- Shardlow, T., R. Hilborn, and D. Lightly. 1987. Components analysis of instream escapement methods for Pacific salmon (*Oncorhynchus* spp.). *Canadian Journal of Fisheries and Aquatic Sciences* 44:1031-1037.
- Shepherd, B.G., G.F. Hartman, and W.J. Wilson. 1986. Relationships between stream and intra-gravel temperatures in coastal drainages, and some implications for fisheries workers. *Canadian Journal of Fisheries and Aquatic Sciences* 43:1818-1822.
- Shirazi, M.A., and W.K. Siem. 1979. A stream systems evaluation - an emphasis on spawning habitat for salmonids. United States Environmental Protection Agency, EPA-600/3-79-109, Corvallis, Oregon.
- Shirvell, C.S. 1994. Effect of changes in streamflow on the microhabitat use and movements of sympatric juvenile coho salmon (*Oncorhynchus kisutch*) and chinook salmon (*O. tshawytscha*) in a natural stream. *Canadian Journal of Fisheries and Aquatic Sciences* 51:1644-1652.
- Slater, D.W. 1963. Winter-run chinook salmon in the Sacramento River, California, with notes on water temperature requirements on spawning. United States Fish and Wildlife Service, Special Scientific Report (Fisheries) 461, Washington, D.C.
- Smith, E.P., D.R. Orvos, and J. Cairns. 1993. Impact assessment using the before-after-control-impact models: concerns and comments. *Canadian Journal of Fisheries and Aquatic Sciences* 50:627-637.
- Snedecor, A.W., and W.G. Cochran. 1967. *Statistical Methods*, 6th edition. Iowa State University Press, Ames, Iowa.

- Snieszko, S.F. 1974. The effects of environmental stress on outbreaks of infectious diseases of fishes. *Journal of Fish Biology* 6:197-208.
- Solazzi, M.F. 1984. Relationships between visual counts of coho, chinook, and chum salmon from spawning fish surveys and the actual number of fish present. Oregon Department of Fish and Wildlife, Information Reports (Fish) 84-7, Portland.
- Solazzi, M.F., T.E. Nickelson, and S.L. Johnson. 1991. Survival, contribution, and return of hatchery coho salmon (*Oncorhynchus kisutch*) released into freshwater, estuarine, and marine environments. *Canadian Journal of Fisheries and Aquatic Sciences* 48:248-253.
- Stevens, D.E., and L.W. Miller. 1983. Effects of river flow on abundance of young chinook salmon, American shad, longfin smelt, and delta smelt in the Sacramento-San Joaquin river system. *North American Journal of Fisheries Management* 3:425-437.
- Swain, D.P., and B.E. Riddell. 1990. Variation in agonistic behavior between newly emerged juveniles from hatchery and wild populations of coho salmon, *Oncorhynchus kisutch*. *Canadian Journal of Fisheries and Aquatic Sciences* 47:566-571.
- Tallman, R.F., and M.C. Healey. 1991. Phenotypic differentiation in seasonal ecotypes of chum salmon, *Oncorhynchus keta*. *Canadian Journal of Fisheries and Aquatic Sciences* 48:661-671.
- Taylor, E.B. 1990. Environmental correlates of life-history variation in juvenile chinook salmon, *Oncorhynchus tshawytscha* (Walbaum). *Journal of Fish Biology* 37:1-17.
- Taylor, S.G. 1980. Marine survival of pink salmon fry from early and late spawners. *Transactions of the American Fisheries Society* 109:79-82.
- Thorne, R.E., and J.J. Ames. 1987. A note on variability of marine survival of sockeye salmon (*Oncorhynchus nerka*) and effects on spawning success. *Canadian Journal of Fisheries and Aquatic Sciences* 44:1791-1795.
- United States Congress. 1962. Rogue River basin, Oregon and California. Public Law 87-874, 87th Congress, 2nd Session, House Document 566.
- Unwin, M.J. 1986. Stream residence time, size characteristics, and migration patterns of juvenile chinook salmon (*Oncorhynchus tshawytscha*) from a tributary of the Rakaia River, New Zealand. *New Zealand Journal of Marine and Freshwater Research* 20:231-252.
- Unwin, M.J. 1997a. Fry-to-adult survival of natural and hatchery-produced chinook salmon (*Oncorhynchus tshawytscha*) from a common origin. *Canadian Journal of Fisheries and Aquatic Sciences* 54:1246-1254.
- Unwin, M.J. 1997b. Survival of chinook salmon, *Oncorhynchus tshawytscha*, from a spawning tributary of the Rakaia River, New Zealand, in relation to spring and summer mainstem flows. *United States National Marine Service, Fishery Bulletin* 95:812-825.

- Unwin, M.J., and G.J. Glova. 1997. Changes in life history parameters in a naturally spawning population of chinook salmon (*Oncorhynchus tshawytscha*) associated with releases of hatchery-reared fish. *Canadian Journal of Fisheries and Aquatic Sciences* 54:1235-1245.
- Unwin, M.J., and D.H. Lucas. 1993. Scale characteristics of wild and hatchery chinook salmon (*Oncorhynchus tshawytscha*) in the Rakaia River, New Zealand, and their use in stock identification. *Canadian Journal of Fisheries and Aquatic Sciences* 50:2475-2484.
- Unwin, M.J., and T.P. Quinn. 1993. Homing and straying patterns of chinook salmon (*Oncorhynchus tshawytscha*) from a New Zealand hatchery: spatial distribution of strays and effects of release date. *Canadian Journal of Fisheries and Aquatic Sciences* 50:1168-1175.
- USACE (United States Army Corps of Engineers). 1967. Design Memorandum Number 8: Fish Facilities. Lost Creek Reservoir, Rogue River, Oregon. Portland District, Portland, Oregon.
- USACE (United States Army Corps of Engineers). 1972. Final environmental statement. Lost Creek Lake Project, Rogue River, Oregon. Portland District, Portland, Oregon.
- USACE (United States Army Corps of Engineers). 1983. Water quality investigations--1981, Lost Creek Lake Project, Rogue River, Oregon. Portland District, Portland, Oregon.
- USACE (United States Army Corps of Engineers). 1991. Final environmental statement. Elk Creek Lake Project, Rogue River, Oregon. Portland District, Portland, Oregon.
- van den Berghe, E.P., and M.R. Gross. 1984. Female size and nest depth in coho salmon (*Oncorhynchus kisutch*). *Canadian Journal of Fisheries and Aquatic Sciences* 41:204-206.
- van den Berghe, E.P., and M.R. Gross. 1986. Length of breeding life of coho salmon (*Oncorhynchus kisutch*). *Canadian Journal of Zoology* 64:1482-1486.
- Van Hying, J.M. 1973. Factors affecting the abundance of fall chinook salmon in the Columbia River. Oregon Fish Commission, Research Briefs 4:1-87.
- Vigg, S., and C.C. Burley. 1991. Temperature-dependent maximum daily consumption of juvenile salmonids by northern squawfish (*Ptychocheilus oregonensis*) from the Columbia River. *Canadian Journal of Fisheries and Aquatic Sciences* 48:2491-2498.
- Wales, J.H., and M. Coots. 1954. Efficiency of chinook spawning in Fall Creek, California. *Transactions of the American Fisheries Society* 84:137-149.
- Walters, C.J. 1986. Adaptive management of renewable resources. MacMillan Publishing Company, New York.

- Waples, R.S. 1991. Genetic interactions between hatchery and wild salmonids: lessons from the Pacific Northwest. *Canadian Journal of Fisheries and Aquatic Sciences* 48 (Supplement 1):124-133.
- Ward, B.R., P.A. Slaney, A.R. Facchin, and R.W. Land. 1989. Size-biased survival in steelhead trout (*Oncorhynchus mykiss*): back-calculated lengths from adults' scales compared to migrating smolts at the Keogh River, British Columbia. *Canadian Journal of Fisheries and Aquatic Sciences* 46:1853-1858.
- Weatherley, A.H. 1972. Growth and ecology of fish populations. Academic Press, London and New York.
- Webb, J.H., and H.A. McLay. 1996. Variation in time of spawning of Atlantic salmon (*Salmo salar*) and its relationship to temperature in the Abeerdeenshire Dee, Scotland. *Canadian Journal of Fisheries and Aquatic Sciences* 53:2739-2744.
- Wedemeyer, G. 1970. The role of stress in disease resistance of fishes. *American Fisheries Society, Special Publication* 5:30-36.
- Wertheimer, A. 1988. Hooking mortality of chinook salmon released by commercial trollers. *North American Journal of Fisheries Management* 8:346-355.
- Wertheimer, A., A. Celewycz, H. Jaenicke, D. Mortensen, and J. Orsi. 1989. Size-related hooking mortality of incidentally caught chinook salmon, *Oncorhynchus tshawytscha*. *Marine Fisheries Review* 51(2):28-35.
- Wickett, W.P. 1958. Review of certain environmental factors effecting the production of pink and chum salmon. *Journal of the Fisheries Research Board of Canada* 15:1103-1125.
- Winton, J., and R. Hilborn. 1994. Lessons from supplementation of chinook salmon in British Columbia. *North American Journal of Fisheries Management* 14:1-13.
- Yoshiyama, R.M., F.W. Fisher, and P.B. Moyle. 1998. Historical abundance and decline of chinook salmon in the Central Valley region of California. *North American Journal of Fisheries Management* 18:487-521.
- Zar, J.H. 1984. *Biostatistical Analysis*, 2nd edition. Prentice-Hall, Inc., Englewood Cliffs, New Jersey.
- Zaugg, W.S., J.E. Bodle, J.E. Manning, and E. Wold. 1986. Smolt transformation and seaward migration in 0-age progeny of adult spring chinook (*Oncorhynchus tshawytscha*) matured early with photoperiod control. *Canadian Journal of Fisheries and Aquatic Sciences* 43:885-888.